



TL

VIDEO CD CHANGER RECEIVER

雅马哈VCD收音扩音机

EMX-220VCD

OWNER'S MANUAL

使用说明书



SUPPLIED ACCESSORIES
ACCESORIOS INCLUIDOS

- After unpacking, check that the following parts are contained.
- Desembalar el aparato y verificar que los siguientes accesorios están en la caja.

- Remote control transmitter
- Transmisor del control remoto

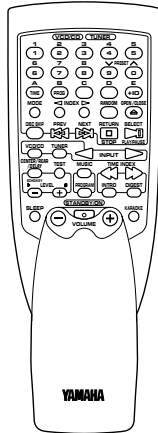

- AM loop antenna
- Antena de cuadro AM

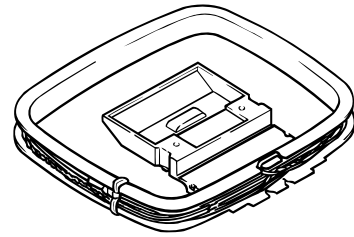

- Batteries (size AA, UM/SUM-3, R6, HP-7)
- Pilas (tamaño AA, tipo UM/SUM-3, R6, HP-7)

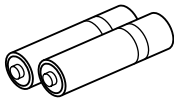

- Indoor FM antenna
- Antena interior de FM

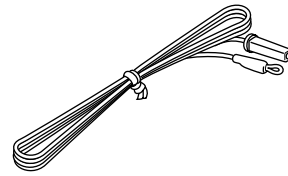

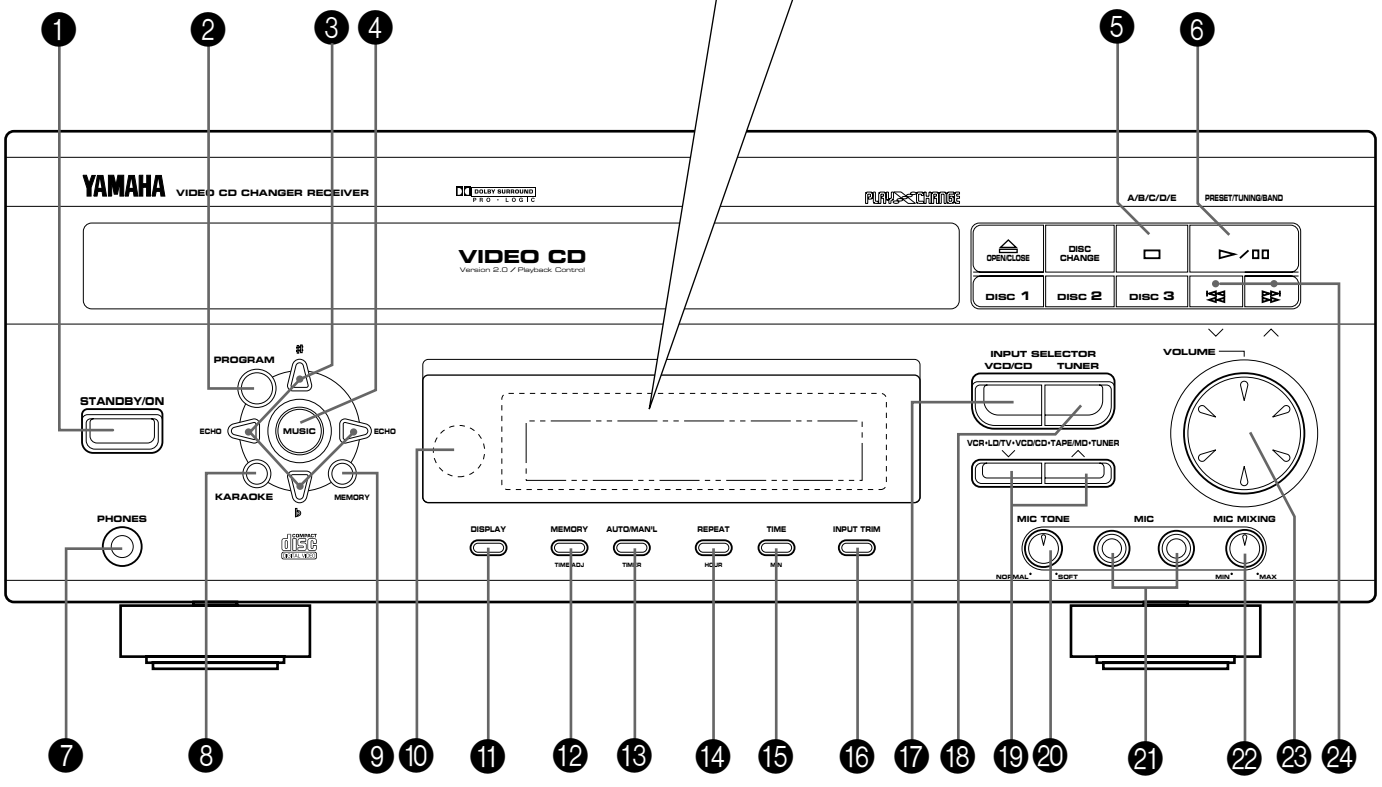
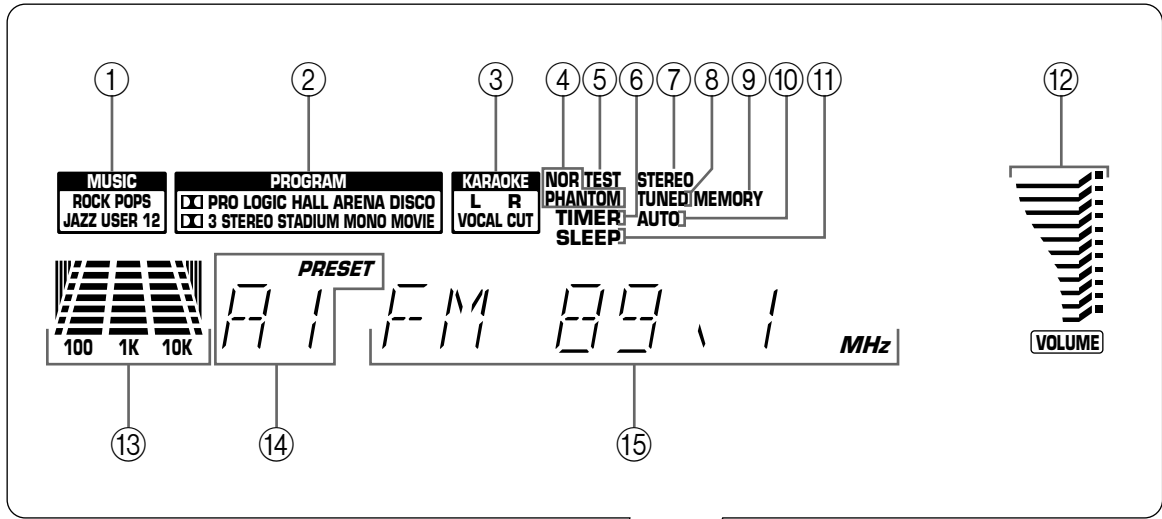

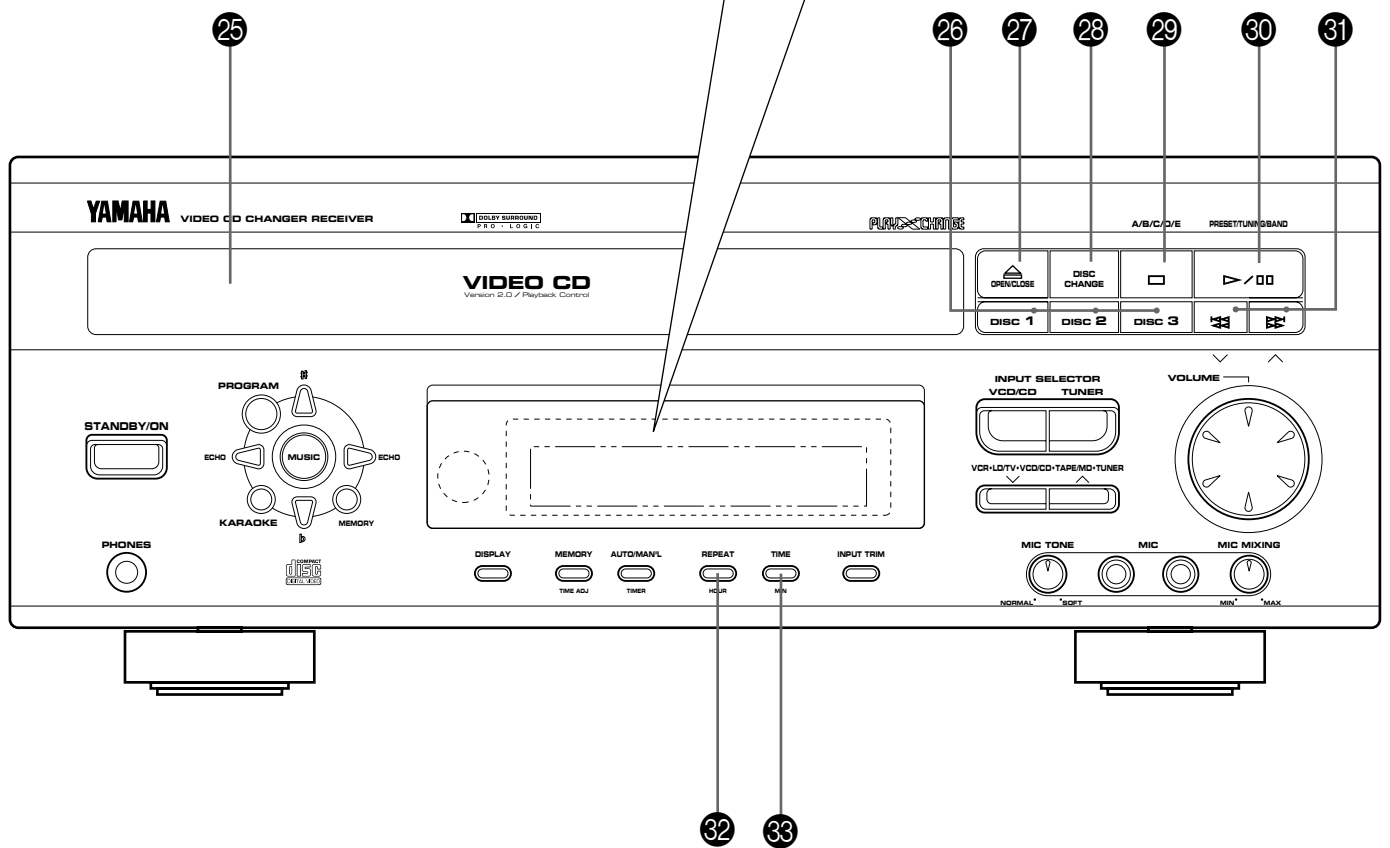
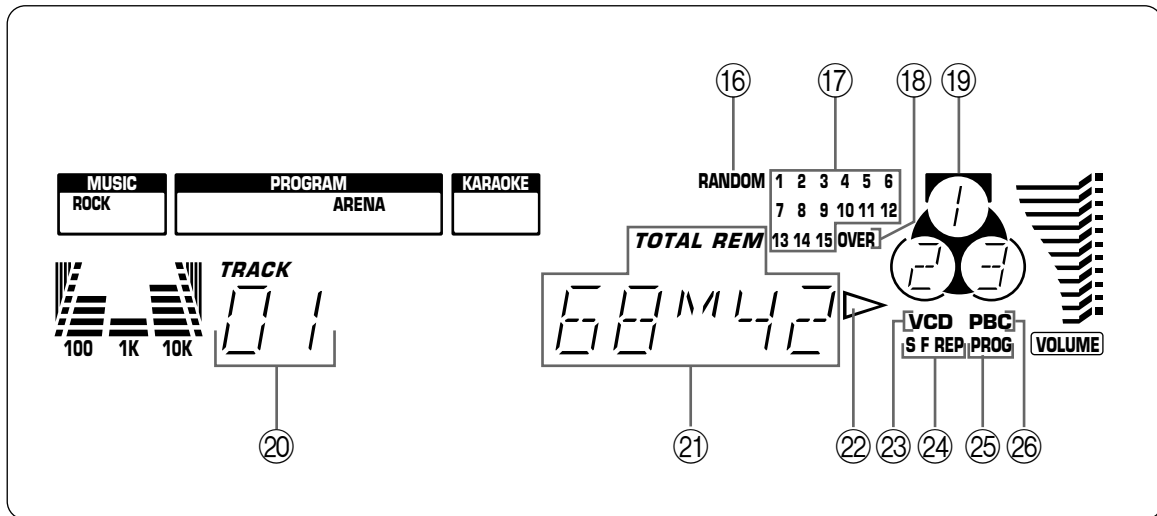

3

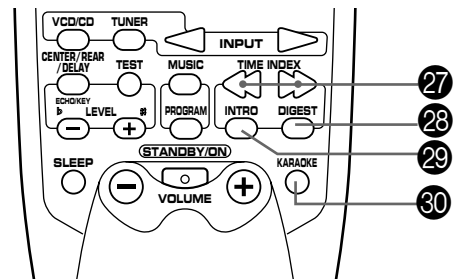
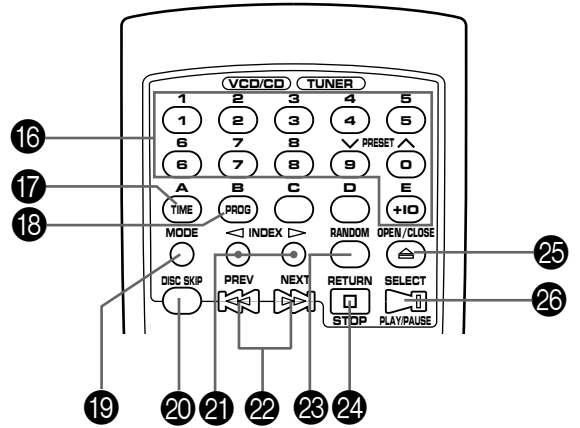
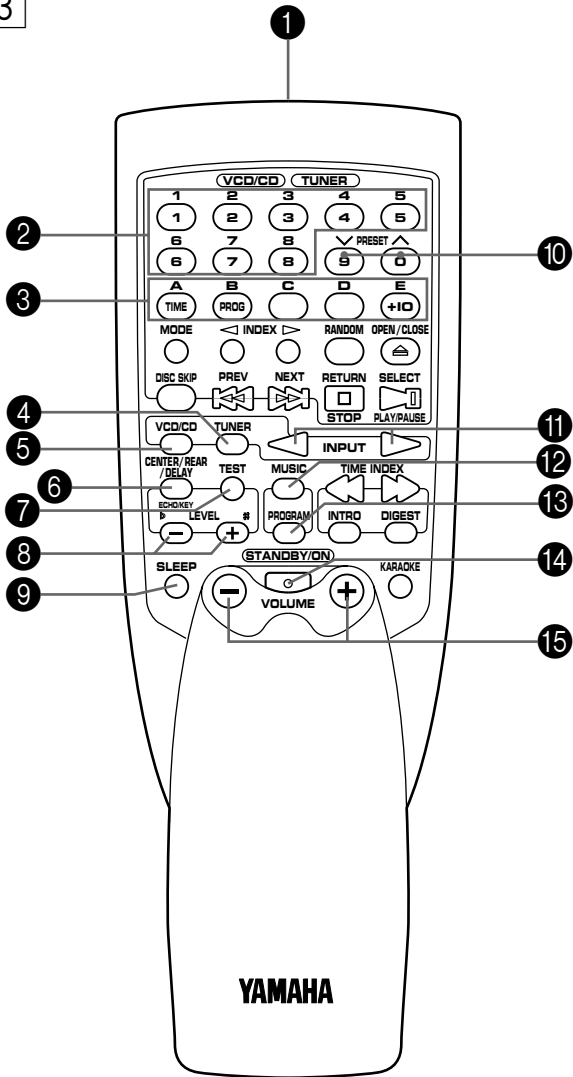

4

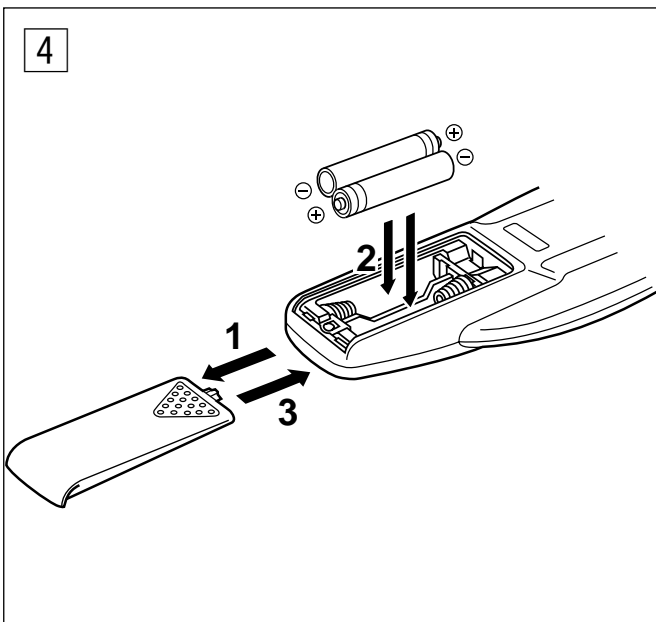

5

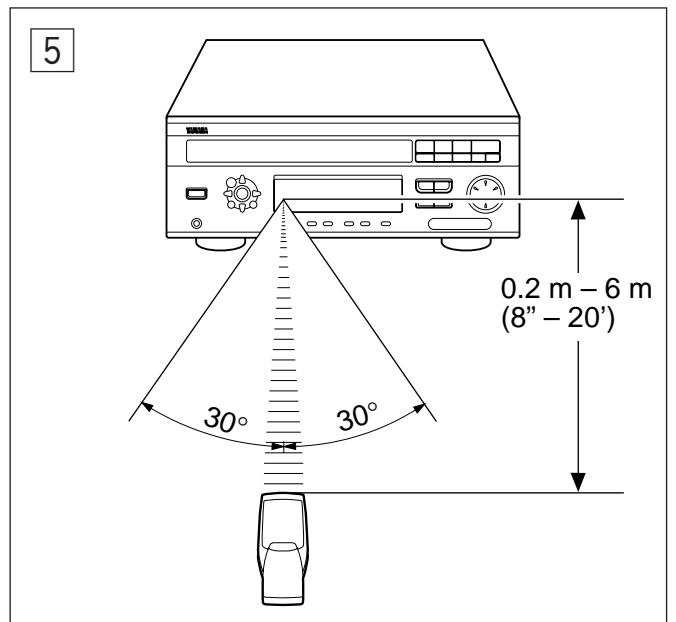

Center speaker
Altavoz central

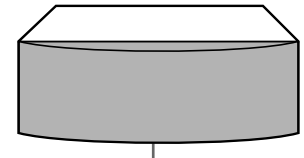

Rear speakers
Altavoces traseros

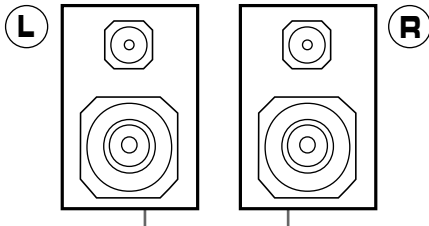

Front speakers
Altavoces delanteros

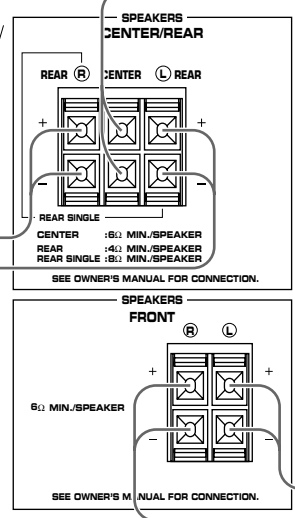
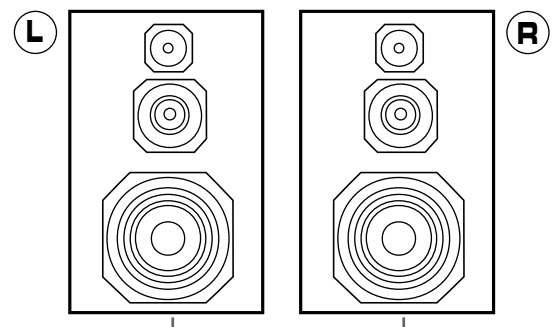

(General model)
(Modelo General)

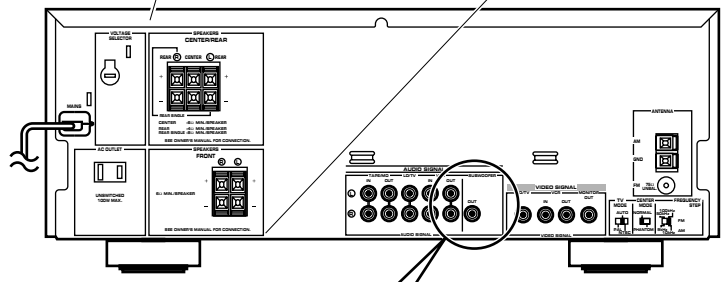

Subwoofer system
Sistema de altavoz de graves secundarios

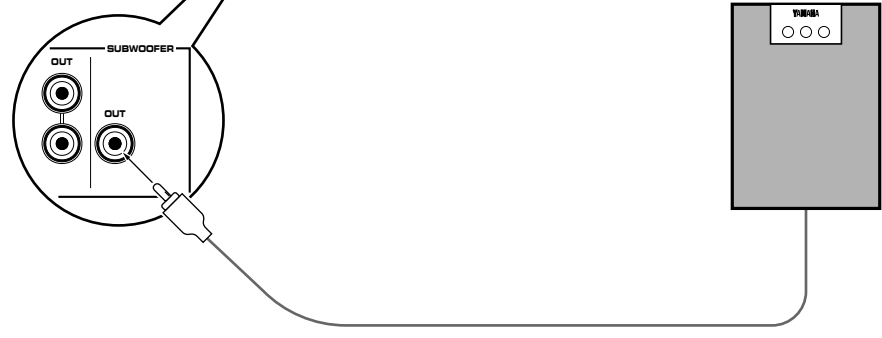

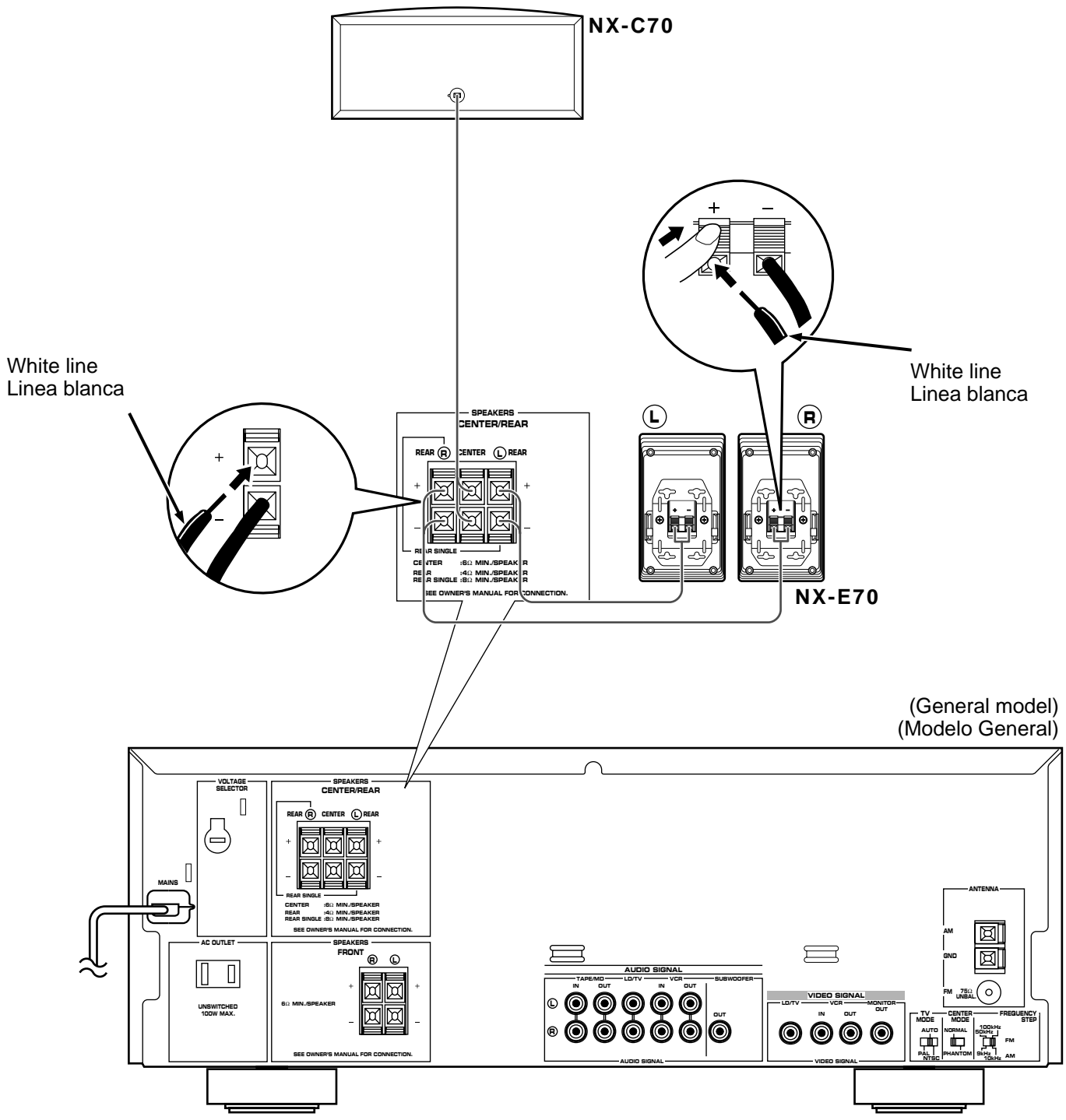

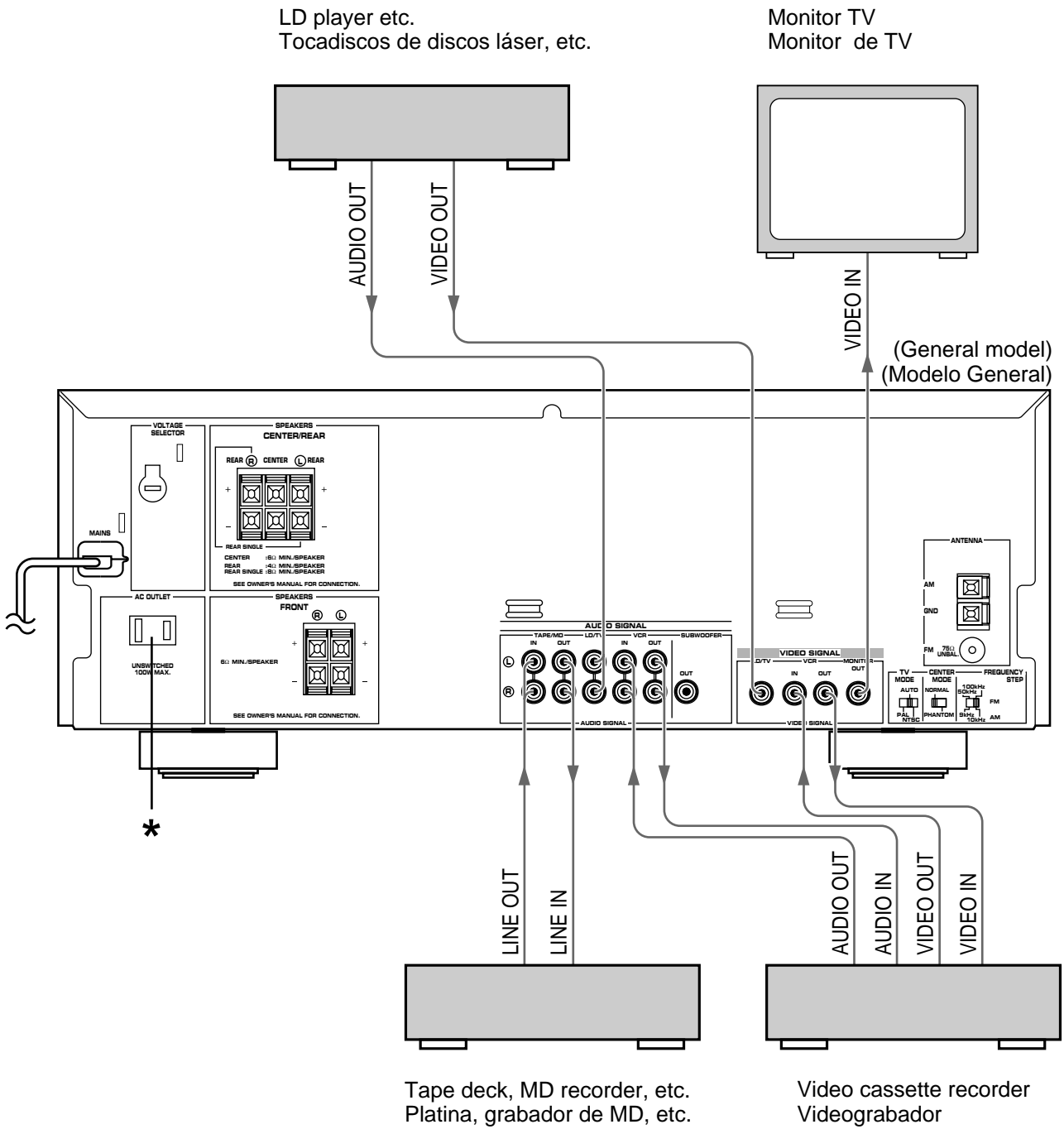

ENGLISH

INTRODUCTION

Thank you for purchasing this YAMAHA product. We hope it will give you many years of trouble-free enjoyment. For the best performance, read this manual carefully. It will guide you in operating your YAMAHA product.

CONTENTS

	Page		Page
PRECAUTIONS.....	2-3	TUNING OPERATION	30-32
FEATURES	4	OPERATING EXTERNAL UNITS CONNECTED WITH THIS UNIT.....	33
NAMES OF CONTROLS AND INDICATORS	5	USING GRAPHIC EQUALIZER	34-36
REMOTE CONTROL TRANSMITTER	6	USING SOUND FIELD PROCESSOR	37-40
SETTING UP THE SPEAKERS	7-9	KARAOKE OPERATION.....	41-43
CONNECTIONS	10-12	HOW TO USE THE BUILT-IN TIMER	44-46
STARTING THE OPERATION OF THIS UNIT	13-14	TROUBLESHOOTING	47-48
ADJUSTMENTS.....	14-17	SPECIFICATIONS	49
VIDEO CD PLAYER OPERATION	18-26		
PLAYBACK CONTROL OF VIDEO CD (Ver. 2.0).....	27-29		

For basic source play, the following illustrations on top of pages will help you to look for the section you need.



.....Video CD (CD) playback



.....Tuning

PRECAUTIONS: READ THIS BEFORE OPERATING YOUR UNIT

- To assure the finest performance, please read this manual carefully. Keep it in a safe place for future reference.
- Choose the installation location of this unit carefully. Avoid placing it in direct sunlight or close to a source of heat. Also avoid locations subject to vibration and excessive dust, heat, cold or moisture. Keep it away from sources of hum such as transformers and electric motors.
- Do not operate this unit upside-down. It may overheat, possibly causing damage.
- Never open the cabinet. If something drops into the set, contact your dealer.
- For Singapore model :
The openings on the cabinet assure proper ventilation of the unit. If these openings are obstructed, the temperature inside the cabinet will rise rapidly. Therefore, avoid placing objects against these openings, and install the unit in well-ventilated condition. Be sure to allow a space of at least 20 cm behind, 20 cm on the both sides and 30 cm above the top panel of the unit. Otherwise it may not only damage the unit, but also cause fire.
- Always set the VOLUME control to minimum before starting an audio source play: increase the volume gradually to an appropriate level after play has started.
- When not planning to use this unit for long periods of time (ie., vacation, etc.), disconnect the AC power plug from the wall outlet.
- Grounding or polarization – Precautions should be taken so that the grounding or polarization of the unit is not defeated.
- Do not use force on switches, controls or connection wires. When moving the unit, first disconnect the power plug and the wires connected to other equipment. Never pull the wire itself.
- If an external appliance (TV, radio, etc.) interferes with this unit's operation, move this unit away from such an appliance.
- Do not attempt to clean the unit with chemical solvents; this might damage the finish. Use a clean, dry cloth.
- Be sure to read the "TROUBLESHOOTING" section regarding common operating errors before concluding that the unit is faulty.
- To prevent lightning damage, disconnect the AC power plug and the antenna cable when there is an electrical storm.
- Do not connect audio equipment to the AC outlet on the rear panel if the equipment requires more power than the outlet is rated to provide.
- Do not plug the AC power plug to the wall socket before you finish all connections.
- The voltage to be used must be the same as that specified on this unit. Using this unit with a higher voltage than specified is dangerous and may result in a fire or other types of accidents causing damage. YAMAHA will not be held responsible for any damage resulting from use of this unit with a voltage other than specified.
- The sound level at a given volume setting depends on speaker location and other factors. Care should be taken to avoid exposure to sudden high levels of sound, which may occur when turning on the unit with the volume control setting at high, and to continuous high levels of sound.
- Sudden temperature changes and storage or operation in an extremely humid environment may cause condensation inside the cabinet. Condensation can cause the unit to malfunction.

To eliminate condensation:
 - **Pickup**
Leave the power on with no disc in the unit until normal playback is possible (about 1 hour).
 - **Remote control**
Wipe off condensation on the transmitter window with a soft cloth before operating the unit.
- To prevent a malfunction of this unit:
 - Do not use any non standard shaped disc (heart etc.) available on the market, because it may damage the unit.
 - Do not use a disc with tape, seals, or paste on it, because damage to the unit may result.

IMPORTANT

Please record the serial number of this unit in the space below.

Model:

Serial No.:

The serial number is located on the rear of the unit. Retain this Owner's Manual in a safe place for future reference.

WARNING

TO REDUCE THE RISK OF FIRE OR ELECTRIC SHOCK, DO NOT EXPOSE THIS APPLIANCE TO RAIN OR MOISTURE.

PRECAUTIONS: READ THIS BEFORE OPERATING YOUR UNIT

NOTE

Please check the copyright laws in your country to record from records, compact discs, radio, etc. Recording of copyright material may infringe copyright laws.

CAUTION FOR CARRYING THIS UNIT

Be sure not to carry or tip this unit with discs remaining in it.

CAUTION FOR MOVING THIS UNIT

Before moving this unit, first remove all discs from the disc table and close the table by pressing the OPEN/CLOSE button. After you confirm that "NO DISC" lights up on the display, turn this unit into the standby mode by pressing the STANDBY/ON switch, and then disconnect the power plug from the AC outlet.

VOLTAGE SELECTOR (China and General models only)

The voltage selector on the rear panel of this unit must be set for your local main voltage BEFORE plugging into the AC main supply.

Voltages are 110/120/220/240V AC, 50/60 Hz.

This unit is not disconnected from the AC power source as long as it is connected to the wall outlet, even if this unit itself is turned off. This state is called the standby mode.

In this state, this unit is designed to consume a certain level of power.

WARNING

To reduce the risk of fire or electric shock, do not expose this unit to rain or moisture.

To avoid electrical shock, do not open the cabinet. Refer servicing to qualified personnel only.

CAUTION 1

Use of controls or adjustments or performance of procedures other than those specified herein may result in hazardous radiation exposure.

CAUTION 2

As the laser beam used in this unit is harmful to the eyes, do not attempt to disassemble the cabinet. Refer servicing to qualified personnel only.

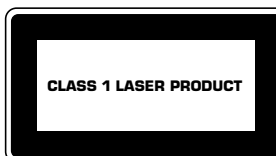

This unit is classified as a CLASS 1 LASER product. The CLASS 1 LASER PRODUCT label is located on the rear exterior.





Laser component in this product is capable of emitting radiation exceeding the limit for Class 1.

Laser Diode Properties

- Material: GaAlAs
- Wavelength: 780nm
- Emission Duration: continuous
- Laser Output: max. 44.6μW*

* This output is the value measured at a distance of about 200mm from the objective lens surface on the Optical Pick-up Block.

The Video CD player on this unit can play discs of the following types only.

Type of disc	Mark printed on the disc	Type of signal recorded	Size (Dimension)	Maximum possible play time
Video CD	 	Sound + Picture (Movie)	12 cm	74 minutes
			8 cm (Single type)	20 minutes
CD (including CD-G)	 	Sound only / Sound + Still picture	12 cm	74 minutes
			8 cm (Single type)	20 minutes

Never attempt to load a disc other than above on this unit because it may cause a damage to this unit and/or other units connected to this unit.

VIDEO CD

Video CDs are classified into two types, version 1.1 and 2.0. This unit can play not only discs of version 1.1, but also version 2.0 on which a Playback Control can be made.

Video CD, version 1.1: With the same operation as compact discs, you can enjoy sounds and pictures (movies).

Video CD, version 2.0: In addition to a normal play which is the same as discs of version 1.1, you can make a Playback Control. (For details on Playback Control, refer to page 27.)

FEATURES

General

- **5-Speaker Configuration**
 - Front L, R: 100W + 100W (6Ω) RMS Output Power, 10% THD, 1 kHz
 - Center: 32W (6Ω) RMS Output Power, 10% THD, 1 kHz
 - Rear: 28W (8Ω) RMS Output Power, 10% THD, 1 kHz
- **Adjustable Display Brightness**
- **Multi-use Timer/Sleep Timer**
- **Automatic Turning This Unit into the Standby Mode**
- **4 External Audio/Video Component Connecting Capability**
- **SUBWOOFER Output Terminal which Passes Low Frequencies Only**
- **Video Output Format Selector (TV MODE) Switch**
- **Remote Control Capability**

Video CD Player

- **3-Disc Carousel Auto-Changer (for Playing Back Video CDs and Compact Discs)**
- **PLAYXCHANGE; Disc Changing Capability while Playing Back Another**
- **20-Track Random Access Programmable Playback**
- **Single Track/Entire Disc/All Disc Repeat Play**
- **Random-sequence Play**
- **Playback Control Function Available for Video CDs, Version 2.0**
- **Quick Overview of a Track and a Disc with a Touch of the DIGEST and INTRO Buttons**

Tuner

- **40 Station Random Access Preset Tuning**
- **40 Station Automatic Preset Tuning**

Sound Field Processor Including Dolby Pro Logic Surround Decoder

- **2 Programs for Dolby Surround Decoding (DOLBY PRO LOGIC and DOLBY 3 STEREO)**
5 Programs for Sound Field Processing (HALL, ARENA, DISCO, STADIUM and MONO MOVIE)
- **Automatic Input Balance Control for Dolby Pro Logic Surround**
- **2 Center Channel Modes (NORMAL/PHANTOM)**
- **Test Tone Generator for Easier Speaker Balance Adjustment**

Graphic Equalizer

- **3-Band Graphic Equalizer**
- **3 Preset Graphic Equalizer Modes Selectable According to the Music Source (ROCK, POPS and JAZZ)**
- **2 Equalizer Pattern Storing Capability**

Karaoke-functions

- **4 Modes for Singing Karaoke**
- **2 Microphone Connecting Capability**
- **MIC Mixing Level and MIC Tone Controls**
- **Echo Level and Key Level Control Capability**
- **Karaoke Sound Recording Capability (Recording Your Singing Voice and Karaoke Effects with the Music Source)**

Dolby Pro Logic Surround

This unit employs a Dolby Pro Logic Surround decoder similar to professional Dolby Stereo decoders used in many movie theaters. By using the Dolby Pro Logic Surround decoder, you can experience the dramatic realism and impact of Dolby Surround movie theater sound in your own home. Dolby Pro Logic employs a four-channel-five-speaker system. The Pro Logic Surround system divides the input signal into four levels: the left and right main channels, the center channel (used for dialog), and the rear surround sound channels (used for sound effects, background noise, and other ambient noises). The center channel allows listeners seated in even less-than-ideal positions to hear the dialog originating from the action on the screen while experiencing good stereo imaging.

Dolby Surround is encoded on the sound track of pre-recorded video tapes, laser discs, and some TV/cable broadcasts. When you play a source encoded with Dolby Surround on this unit, the Dolby Pro Logic Surround decoder decodes the signal and distributes the surround-sound effects.

In addition, this unit features a built-in automatic input balance control. This always assures you the best performance without manual adjustment.



Manufactured under license from Dolby Laboratories Licensing Corporation. DOLBY, the double-D symbol and "PRO LOGIC" are trademarks of Dolby Laboratories Licensing Corporation.

NAMES OF CONTROLS AND INDICATORS

For amplifier/tuner

(See figure 1 on page 3 at the beginning part of this manual.)

Display

- ① Preset Equalizer Mode Indicator (**MUSIC**)
- ② Sound Field Program Indicator (**PROGRAM**)
- ③ Karaoke Mode Indicator (**KARAOKE**)
- ④ Center Channel Mode (**NOR/PHANTOM**) Indicator
- ⑤ **TEST** Indicator
- ⑥ **TIMER** Set Indicator
- ⑦ **STEREO** Indicator
- ⑧ **TUNED** Indicator
- ⑨ **MEMORY** Indicator
- ⑩ **AUTO** Tuning Indicator
- ⑪ **SLEEP** Indicator
- ⑫ Volume Level Meter (**VOLUME**)
- ⑬ Graphic Equalizer Level Indicators
- ⑭ Preset Number Indicator (**PRESET**)
- ⑮ Multi Information Display
(Time, Station Frequency, Volume Level, etc.)
- ① **STANDBY/ON** Switch
- ② **PROGRAM** Selector Button
- ③ Equalizer Control Buttons
(**ECHO** Buttons)
(Key Level Control  /  Buttons)
- ④ **MUSIC** Button
- ⑤ **A/B/C/D/E** Button
- ⑥ **PRESET/TUNING/BAND** Selector Button
- ⑦ **PHONES** Jack
- ⑧ **KARAOKE** Button
- ⑨ User Program **MEMORY** Button
- ⑩ Remote Control Sensor
- ⑪ **DISPLAY** Button
- ⑫ Tuner **MEMORY (TIME ADJUST)** Button
- ⑬ **AUTO/MAN'L (TIMER)** Button
- ⑭ **REPEAT (HOUR)** Button
- ⑮ **TIME (MIN)** Button
- ⑯ **INPUT TRIM** Button
- ⑰ **VCD/CD INPUT SELECTOR** Button
- ⑱ **TUNER INPUT SELECTOR** Button
- ⑲ **INPUT SELECTOR** ∨ (Down)/ ^ (Up) Buttons
- ⑳ **MIC TONE** (Microphone Tone) Control
- ㉑ **MIC** (Microphone) Jacks
- ㉒ **MIC MIXING** (Microphone Mixing) Level Control
- ㉓ **VOLUME** Control
- ㉔ Tuning ∨ (Down)/ ^ (Up) Buttons

For Video CD player

(See figure 2 on page 4 at the beginning part of this manual.)

Display



- ⑯ **RANDOM** Play Indicator
- ⑰ Music Calendar Indicator
- ⑱ Music Calendar **OVER** Indicator
- ⑲ Disc Indicator
- ⑳ Track Number Indicator (**TRACK**)
- ㉑ Time Display
- ㉒ Play Indicator: ▷
- ㉓ **VCD** (Video CD) Indicator
- ㉔ **(S, F) REPEAT** Indicator
- ㉕ Program (**PROG**) Play Indicator
- ㉖ **PBC** (PLAYBACK CONTROL) Indicator
- ㉗ Disc Table
- ㉘ **DISC** Selector Buttons
- ㉙ **OPEN/CLOSE** Button: 
- ㉚ **DISC CHANGE** Button
- ㉛ Stop Button: □
- ㉜ Play/Pause Button: ▷/⏸
- ㉝ Skip Buttons: ⏮/⏭
(Search Buttons: ⏮/⏭)
- ㉞ **REPEAT** Button
- ㉟ **TIME** Button

REMOTE CONTROL TRANSMITTER

Names of control buttons

(See figure 3 on page 5 at the beginning part of this manual.)

■ Amplifier/tuner control buttons

- 1 Remote Control Transmitter Window
- 2 Preset Station Number Buttons
- 3 A, B, C, D, E Selector Buttons
- 4 TUNER Input Selector Button
- 5 VCD/CD Input Selector Button
- 6 CENTER/REAR/DELAY Selector Button (ECHO/KEY Selector Button)
- 7 TEST Button
- 8 LEVEL Control Buttons (Key Level Control  /  Buttons)
- 9 SLEEP Button
- 10 PRESET Number \vee (Down)/ \wedge (Up) Buttons
- 11 INPUT Selector Buttons
- 12 MUSIC Button
- 13 PROGRAM Button
- 14 STANDBY/ON Switch
- 15 VOLUME – (Down)/+ (Up) Buttons

■ Video CD player control buttons

- 16 Track Number Input Buttons
- 17 TIME Button
- 18 PROGRAM Button
- 19 Disc Play MODE Selector Button
- 20 DISC SKIP Button
- 21 INDEX Buttons
- 22 Skip Buttons: \lll / \ggg
(Search Buttons: \lll / \ggg)
(PREV/NEXT Buttons)
- 23 RANDOM Button
- 24 STOP Button: \square
(RETURN Button)
- 25 OPEN/CLOSE Button: \triangle
- 26 PLAY/PAUSE Button: \triangleright / \square
(SELECT Button)
- 27 TIME INDEX Buttons
- 28 DIGEST Button
- 29 INTRO Button
- 30 KARAOKE Button

Loading the batteries for the remote control transmitter

(See figure 4 on page 5.)

- 1 Remove the battery compartment cover.
(Slide the cover in the direction of the arrow.)
- 2 Insert 2 "AA" size batteries (UM/SUM-3, R6, HP-7 or equivalent) into the battery compartment.
* Installing the batteries improperly may cause failure.
- 3 Replace the battery compartment cover.

Precautions for battery use

- Insert the batteries according to the direction indicated in the battery compartment.
- Replace all batteries with new ones at the same time.
- Remove the batteries if they are weak or the unit is not in use for long periods.
- Do not mix normal batteries with rechargeable batteries.

Proper use of the remote control transmitter

(See figure 5 on page 5.)

Aim (within the range of 60° with no obstacles) the remote control transmitter at the remote control sensor and operate as shown.

Notes concerning use

- Replace the batteries if control distance decreases or operation becomes unstable.
- Periodically clean the transmitter window on the remote control transmitter and the sensor on the main unit with a soft cloth.
- Exposing the sensor on the main unit to strong light (especially an inverter type of fluorescent lamp etc.) may interfere with operation. In this case, reposition the main unit to avoid direct lighting.
- Keep the remote control transmitter away from moisture, excessive heat, shock and vibrations.
- The remote control transmitter's usable range is within 0.2m (8") and 6m (20') away from the sensor.

SETTING UP THE SPEAKERS

This unit is designed to provide the best sound-field quality with a 5-speaker configuration: a pair of front speakers, a pair of rear speakers and a center speaker. You can use one rear speaker only instead of using two rear speakers, and omit the center speaker. (Refer to the “**Speaker configuration**” shown below.)

The front speakers are used for the main source sound plus the effect sounds. The rear speakers are used for the effect and surround sounds, and the center speaker is for the center sounds (dialog etc.).

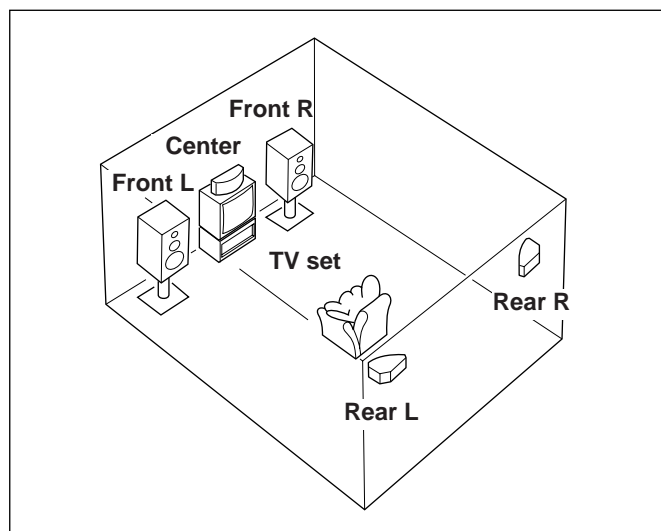
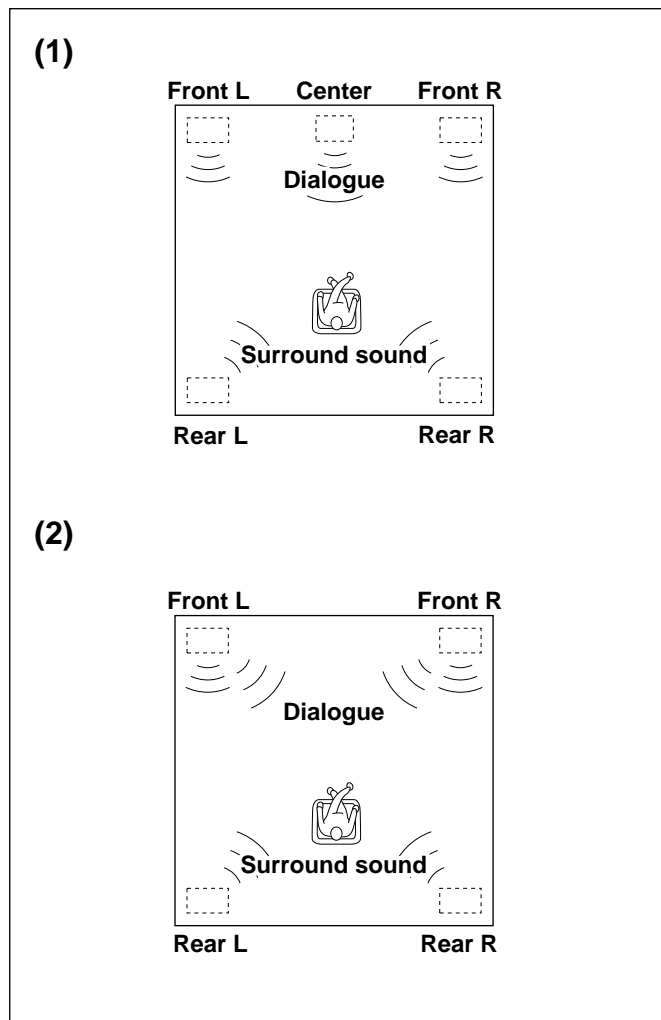

Speaker configuration

(1) 5-Speaker Configuration

This configuration is the most effective and recommended one. In this configuration, the center speaker is necessary as well as the rear speakers. If the sound field program **PRO LOGIC** or **3 STEREO** is selected, conversations will be output from the center speaker and the ambience will be excellent.

- Set the center channel mode to the “**NORMAL**” position. (For details, refer to page 16.)

(2) 4-Speaker Configuration (without the center speaker)

The center speaker is not used in this configuration. If the sound field program **PRO LOGIC** is selected, the center sound will be output from the left and the right front speakers, although the program **3 STEREO** is useless in this configuration. However, the sound effect of other programs can be almost the same as that of the 5-speaker configuration.

- Be sure to set the center channel mode to the “**PHANTOM**” position. (For details, refer to page 16.)

Note

As this unit is equipped with a monaural amplifier for the rear channel, sounds output from the rear speakers are in monaural. So, you may use one rear speaker only instead of using two rear speakers.

However, the use of two rear speakers is recommended when there are more than one listener in the listening room. When using one rear speaker, place it right behind your listening position.

Speaker placement

- Front speakers:** In normal position.
Rear speakers: Behind your listening position, facing slightly inward. Nearly 1.8 m (approx. six feet) up from the floor.
Center speaker: Precisely between the front speakers.

SETTING UP THE SPEAKERS

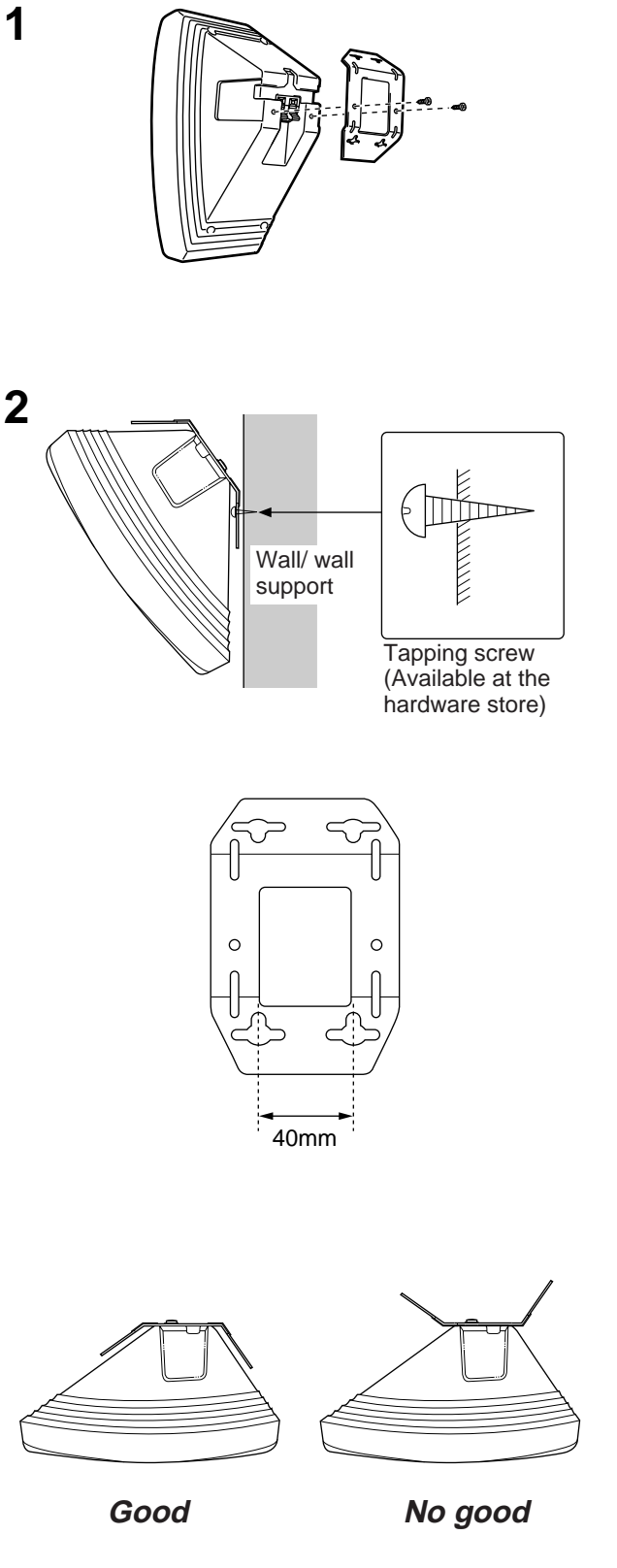

Only for customers who use the YAMAHA NS-P30 speaker system (separate purchase)

If you use the YAMAHA NS-P30 speaker system with this unit, read the following descriptions for mounting the NS-P30.

* "NS-P30" is the package number which includes the YAMAHA speaker systems NX-E70 and NX-C70. NX-E70 is designed to be used as a rear effect speaker system, and NX-C70 is designed to be used as a center speaker system.

■ Mounting the rear speakers (NX-E70)

Mount the rear speakers on a shelf, rack or on the floor directly, or hang them on the wall.

To mount the rear speakers on a wall

- 1 Attach the provided mounting bracket to the rear of the speaker by using the provided screws.
- 2 Fasten screws into a firm wall or wall support as shown in the diagram, and hang the holes of the mounting bracket on the protruding screws.
 - * The holes are arranged so that the speakers can be mounted in a side long, upright or upside-down way.
 - * Make sure that the screws are caught by a narrow part of the holes securely.

Notes

- Never attach the bracket to the speaker backwards.
- Speaker cords should be connected to the speaker's terminals after the bracket is attached to the speaker to prevent the speaker cords pressed between the speaker and the bracket.

SETTING UP THE SPEAKERS

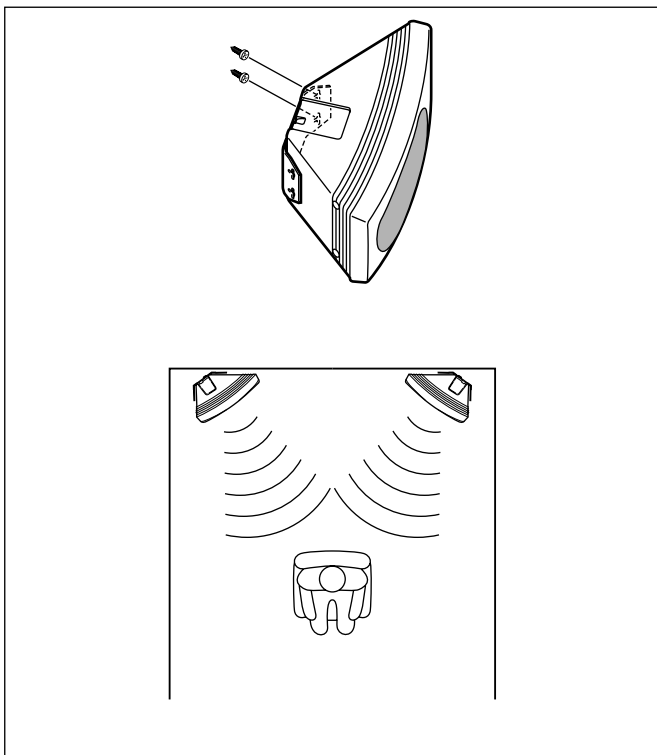

To hang in a side long way

Hang the speakers so that each of them faces inside as figured left.

WARNING:

- Each speaker weighs 0.8 kg (1 lbs. 12 oz.). Do not mount them on thin plywood or soft wall surface material, as the screws may come out of the flimsy surface, causing the speakers to fall down and be damaged, or result in personal injury.
- Do not fasten the speakers to wall with nails, adhesives, or other unsound hardware. Long-term use and vibrations may cause them to fall down.
- To avoid accidents resulting from tripping over loose speaker cables, fix them to the wall.

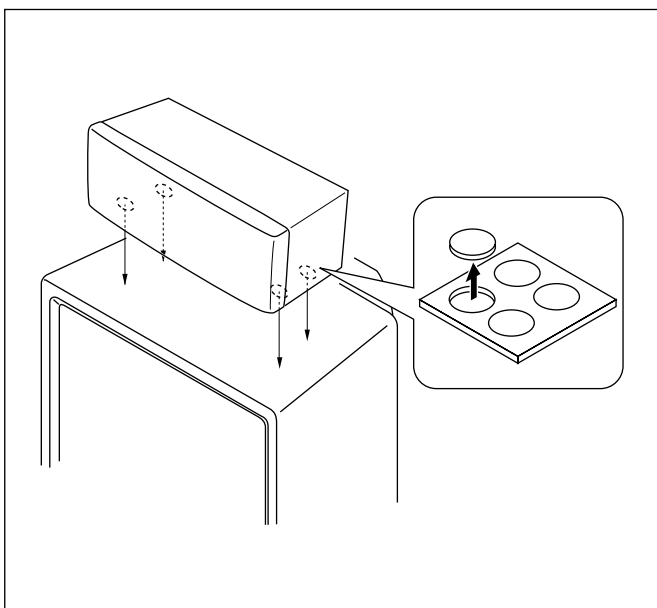

■ Mounting the center speaker (NX-C70)

Place the speaker on top of the TV or on the floor under the TV or inside the TV rack in a stable position.

When placing the speaker on top of the TV, to prevent the speaker from falling down, put the provided pads at four points on bottom of the speaker.

Notes

- Do not place the speaker on top of the TV whose area is smaller than the bottom area of the speaker. If placed, the speaker may drop out causing an injury to you.
- Though this speaker is a magnetic shielding type, there may be some influence on a TV picture depending on the type of TV or the placement of the speaker. In such a case, place the speaker apart from the TV so that there is no influence on TV picture.

CONNECTIONS

Never plug the AC supply lead of this unit into the AC outlet until all connections are completed.

Connecting speakers

(See figure 6 on page 6.)

Connect the front speakers to the FRONT SPEAKERS terminals, the center speaker to the CENTER SPEAKERS terminals and the rear speakers to the REAR SPEAKERS terminals.

Note

Use speakers with the specified impedance shown on the rear of this unit.

How to Connect:

Connect the **SPEAKERS** terminals to your speakers with wire of the proper gauge, cut as short as possible. If the connections are faulty, no sound will be heard from the speakers. Make sure that the polarity of the speaker wires is correct, that is the + and – markings are observed. If these wires are reversed, the sound will be unnatural and lack bass.

Caution

Do not let the bare speaker wires touch each other as this could damage the amplifier and/or speakers.

Red: positive (+)

Black: negative (–)

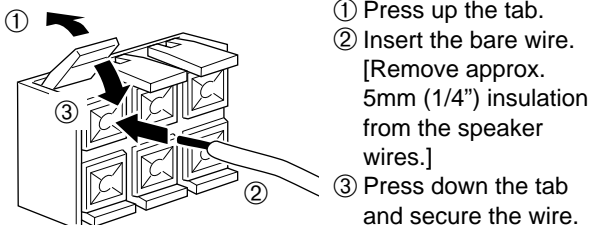

Note on connecting one rear speaker only

You can use one rear speaker only in place of two rear speakers. For connecting one rear speaker, follow the method shown below.

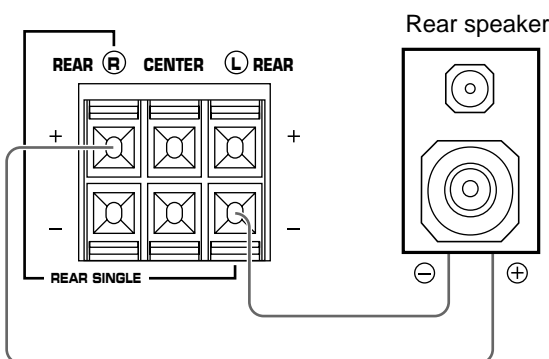

Note on connecting a subwoofer (separate purchase)

You may wish to add a subwoofer to reinforce the bass frequencies.

Connect the SUBWOOFER OUT terminal of this unit to the INPUT terminal of the subwoofer amplifier, and connect the speaker terminals of the subwoofer amplifier to the subwoofer.

With some subwoofer systems, including the Yamaha Active Servo Processing Subwoofer System, an amplifier is incorporated into the system.

* The SUBWOOFER OUT terminal outputs low frequencies from the front and center channels. (The cut-off frequency of signals output from this terminal is 200 Hz.)

How to connect the YAMAHA NS-P30 speaker system (separate purchase) to this unit

(See figure 7 on page 7.)

If you connect the YAMAHA NS-P30 speaker system to this unit, read the following descriptions.

NX-E70 (Rear speakers)

- Connect the push-type input terminals on the rear of the speakers to the REAR SPEAKERS terminals of this unit with the provided speaker cables.
- One side of the speaker cable has a white line and the other side has no line. Connect the (+) terminals on both this unit and the speakers using the side with a white line. Connect the (–) terminals on both components using the side with no line.
- Connect one speaker to the left (marked L) terminals of this unit, and another speaker to the right (marked R) terminals, making sure not to reverse the polarity (+, –). If one speaker is connected with reversed polarity, the sound will be unnatural and lack bass.

Procedures:

- ① Press the tab on the terminal down, as shown in the figure.
- ② Insert the bare speaker wire end properly into the terminal hole. [Remove approx. 5 mm (1/4") insulation from the speaker cable.]
- ③ Remove your finger from the tab to allow it to lock snugly on the cable's wire end.
- ④ Test the security of the connection by tugging lightly on the cable at the terminal.

NX-C70 (Center speaker)

To connect the speaker cable from NX-C70 to the CENTER SPEAKERS terminals of this unit, make sure to connect the side with a white line to the (+) terminal and the side with no line to the (–) terminal.

Antenna connection

(1) Supplied FM antenna

Connect the FM antenna wire to the corresponding terminal and direct the FM antenna wire to the direction where the strongest signal can be received.

(2) Supplied AM loop antenna

Connect the AM loop antenna wires to the corresponding terminals. Position the AM loop antenna for optimum reception. Place the AM loop antenna on a shelf etc., or install it on the rack or wall with screws (not supplied).

Notes

- When static is still heard even after adjusting the position of the AM loop antenna, try reversing the wire connections (from the upper terminal to the lower one, and vice versa).
- Do not place the AM loop antenna on the unit. It will result in noise generation, since the unit is equipped with digital electronics. Place the AM loop antenna away from the unit.

(3) External FM antenna

Use an external FM antenna instead of an indoor FM antenna if you need better reception. Consult your dealer.

(4) External AM antenna

Use an external AM antenna if you need better reception. Consult your dealer.

Note

When using an external AM antenna, be sure to keep the wire of the AM loop antenna connected.

FREQUENCY STEP switch (China and General models only)

Because the interstation frequency spacing differs in different areas, set the FREQUENCY STEP switch (located at the rear) according to the frequency spacing in your area. Before setting this switch, disconnect the AC supply lead of this unit from the AC outlet.

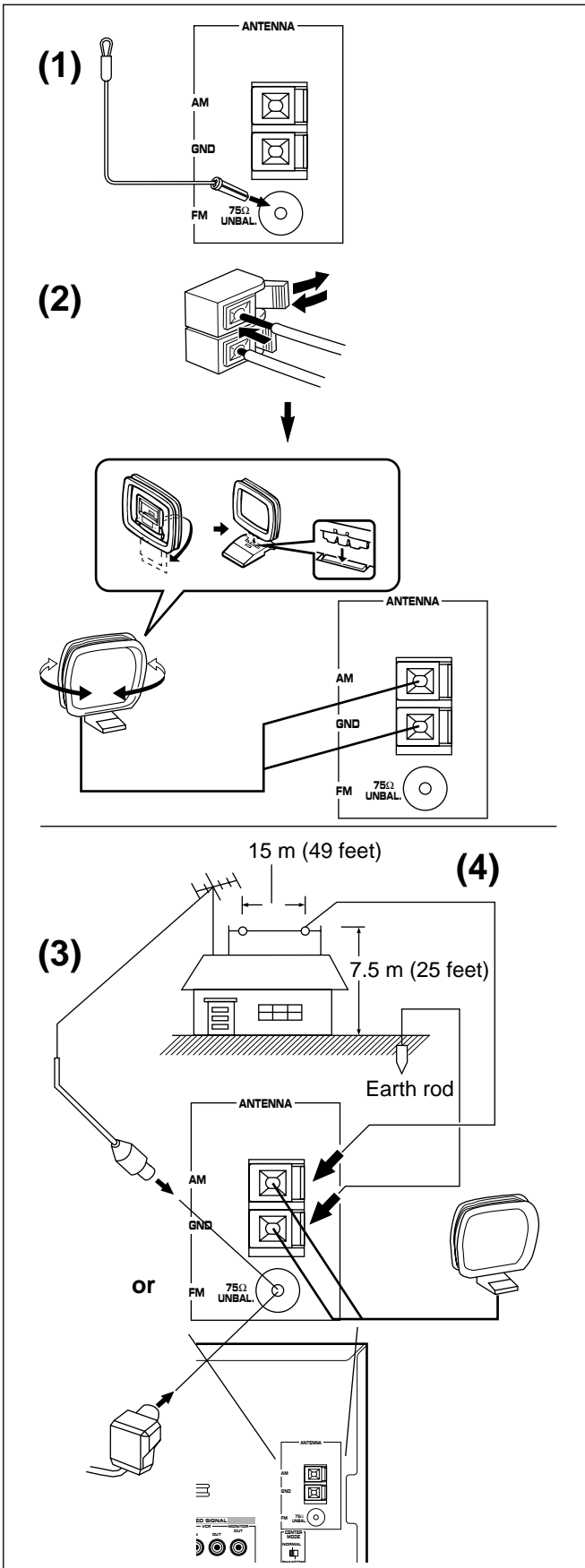

Connecting external components

(See figure 8 on page 8.)

This unit can be connected with external audio and video components. Make connections between this unit and other components using RCA pin plug connector cables correctly, that is to say **L** (left) to **L** and **R** (right) to **R**. Also, refer to the owner's manual for each component to be connected to this unit.

* : AC OUTLET (UNSWITCHED)

The power cord of any audio/video unit can be connected to this outlet.

The power to this outlet is not controlled by this unit's STANDBY/ON switch. This outlet will supply power to the connected unit even if this unit is in the standby mode.

The maximum power that can be connected to this outlet is 100 watts

Setting the video output format selector (TV MODE) switch

The Video CD player built into this unit is designed for use with the NTSC and PAL television formats. Set this switch to the position for the format your monitor TV employs.

PAL: Outputs signals in the PAL format no matter which format (PAL or NTSC) the currently playing disc employs.
Set to this position if your monitor TV employs the PAL format.

AUTO: Outputs signals in the same format as the currently playing disc employs.
Set to this position if your monitor TV can be switched in between the PAL and NTSC formats automatically.

NTSC: Outputs signals in the NTSC format no matter which format (PAL or NTSC) the currently playing disc employs.
Set to this position if your monitor TV employs the NTSC format.

Note

Be sure to play back a disc which employs the same format that your monitor TV employs, otherwise a picture will not be played back normally.

Connecting the AC supply lead

- After completing all connections, plug the AC supply lead into a convenient AC outlet.
- Unplug the AC supply lead from the AC outlet if the unit is not to be used for a long period of time.

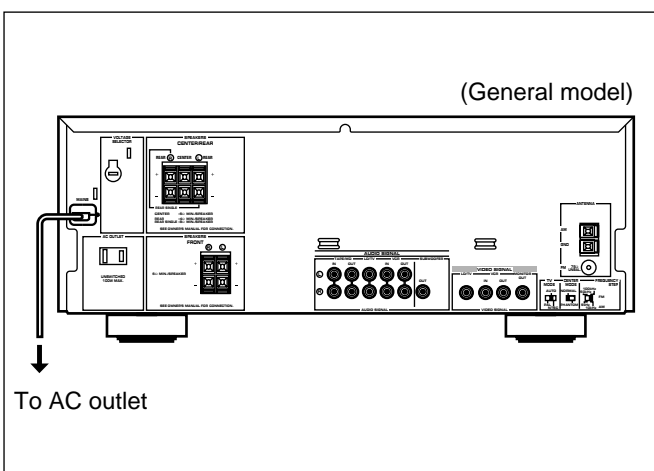
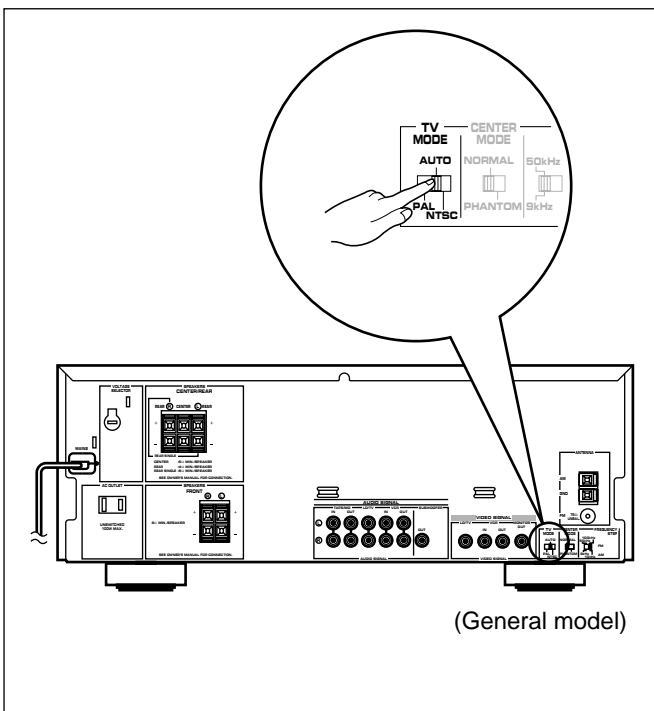

STARTING THE OPERATION OF THIS UNIT

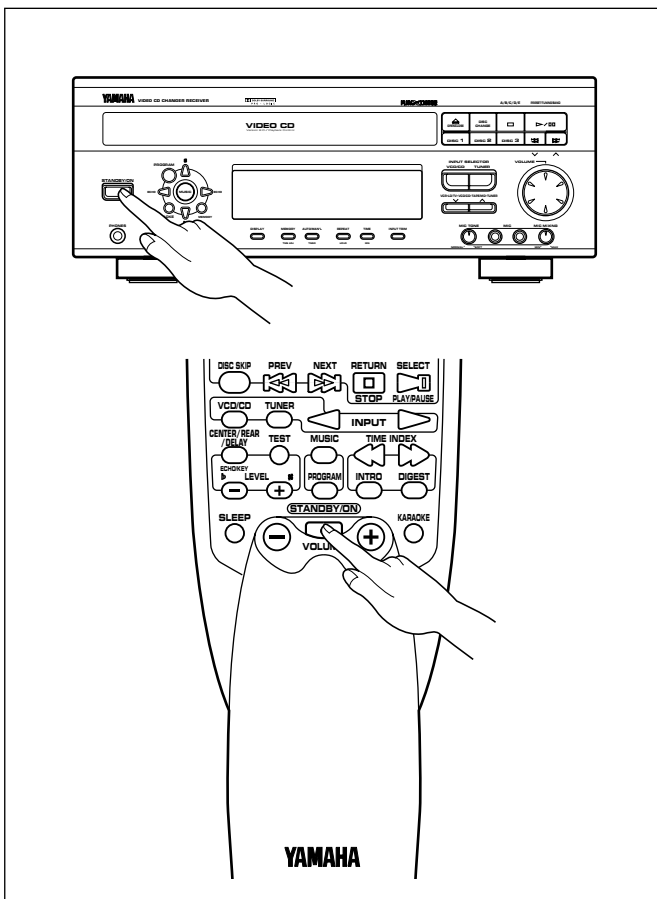

Turning this unit on or into the standby mode

If the AC supply lead is connected to the AC outlet, this unit can be turned on and turned into the standby mode by pressing the STANDBY/ON switch on the front panel of this unit or the STANDBY/ON switch on the remote control transmitter.

- * While this unit is on, the display shows the name of currently selected input source or other information. In the standby mode, the display shows only the time.

Automatic turning this unit into the standby mode

This unit will be automatically turned into the standby mode if 30 minutes pass without any operation on the control parts of this unit after a playback of Video CD (or CD) ends.

- * This function is not available unless time setting is made on the built-in clock.

STANDBY mode

While the power is on, pressing the STANDBY/ON switch (or the STANDBY/ON switch on the remote control transmitter) switches this unit to the standby mode. (In this mode, the display shows only the time.) In this mode, main voltage is still present inside the unit. If you want to switch off this unit completely, disconnect the AC power plug from the AC outlet.

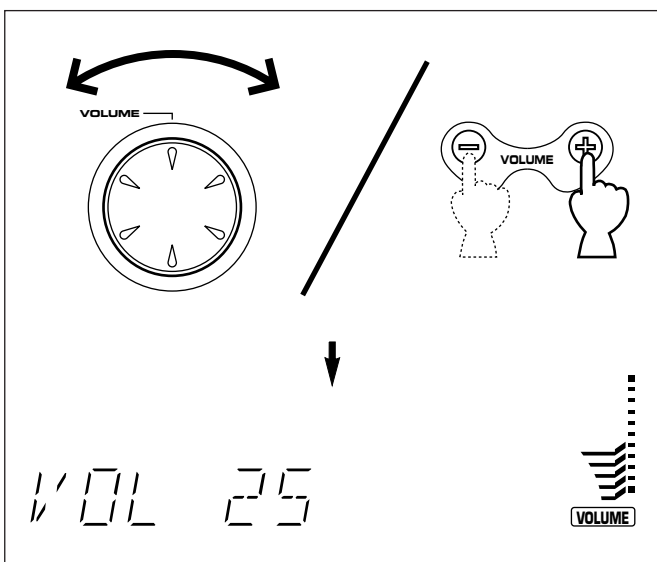

Volume control

Front panel operation

Rotate the VOLUME control clockwise to increase the volume, and counterclockwise to decrease the volume.

Remote control operation

Press the VOLUME + button to increase the volume and the VOLUME - button to decrease the volume.

- * Adjusted volume level is shown by the volume level meter and in figures on the display.

STARTING THE OPERATION OF THIS UNIT

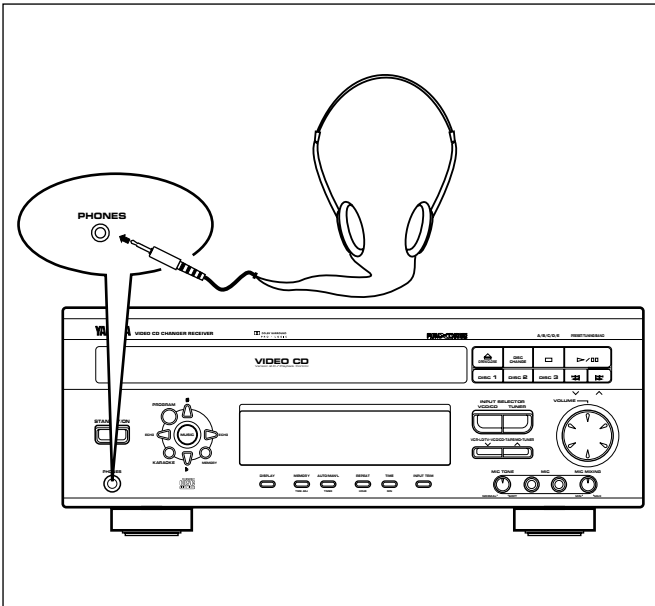

Listening with headphones

- Be sure that your headphones have a 3.5 mm (1/8") diameter plug and are between 16 ohms and 50 ohms impedance. Recommended impedance is 32 ohms.
- When headphones are connected, the speakers are defeated automatically and you can listen to the sound to be output from the front speakers through headphones. Adjust the VOLUME control for desired volume.

ADJUSTMENTS

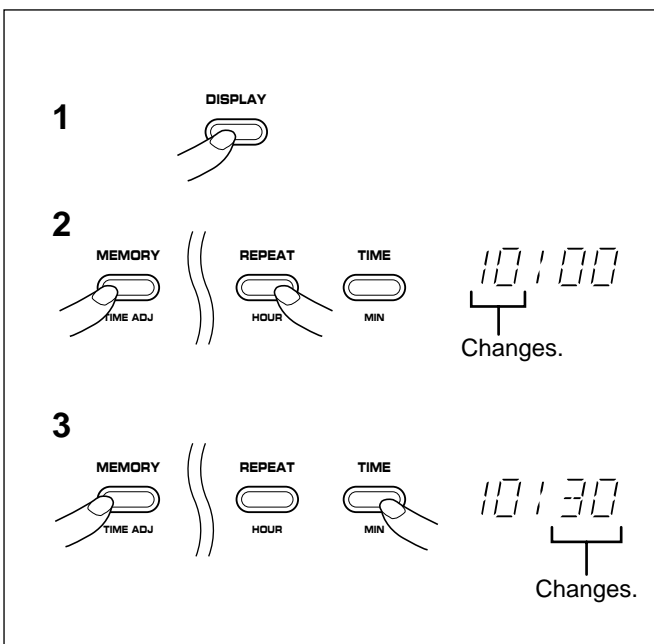

Setting the clock

- 1 While the power is on, press the DISPLAY button to display the time. If this unit is in the standby mode, you can proceed to the next step.
- 2 While holding the TIME ADJ button pressed, press the HOUR button and set the hour.
 - * Press the HOUR button once to advance the time by 1 hour. Press and hold to advance continuously.
- 3 While holding the TIME ADJ button pressed, press the MIN button and set the minute.
 - * Press the MIN button once to advance the time by 1 minute. Press and hold to advance continuously.

Singapore model uses a 24-hour display. For China and General models, either the 24-hour display or the 12-hour display [shown by "AM (PM) 12:00"] is selected depending on the setting of the FREQUENCY STEP switch on the rear panel, so you cannot select a desired type freely.

In the event of a power failure or when the AC supply lead is disconnected.

The time display will go out, however, the clock will function for about 5 minutes without power supply. So you do not have to reset the time if the AC power supply is resumed within about 5 minutes.

When the AC power supply is resumed after more than 5 minutes pass without power supply, the time display will flash on and off to indicate that the time must be reset.

ADJUSTMENTS

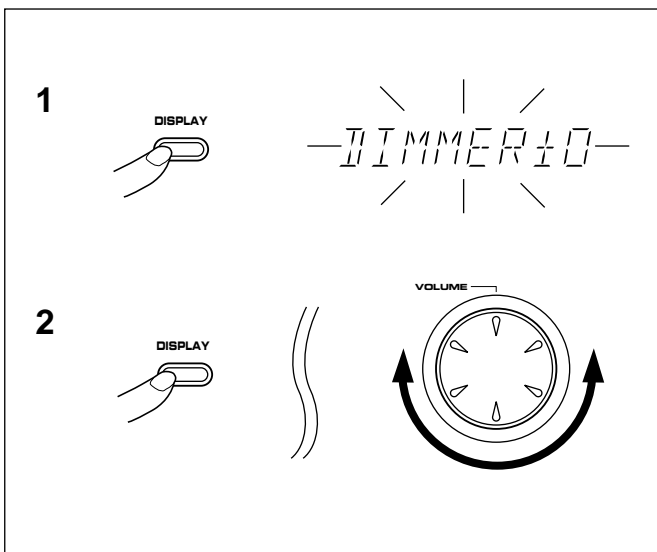

Adjusting brightness of the display

If desired, you can adjust brightness of the display.

- 1 Press and hold the DISPLAY button for more than 2 seconds so that "DIMMER±0" appears on the display.
- 2 Holding the DISPLAY button pressed, turn the VOLUME control clockwise to increase or counterclockwise to decrease brightness.

This adjustment can be made even though this unit is in the standby mode.

Control range

When the power is on: ± 0 to -6 (Preset value: ± 0)

When this unit is in the standby mode: $+3$ to -3 (Preset value: ± 0)

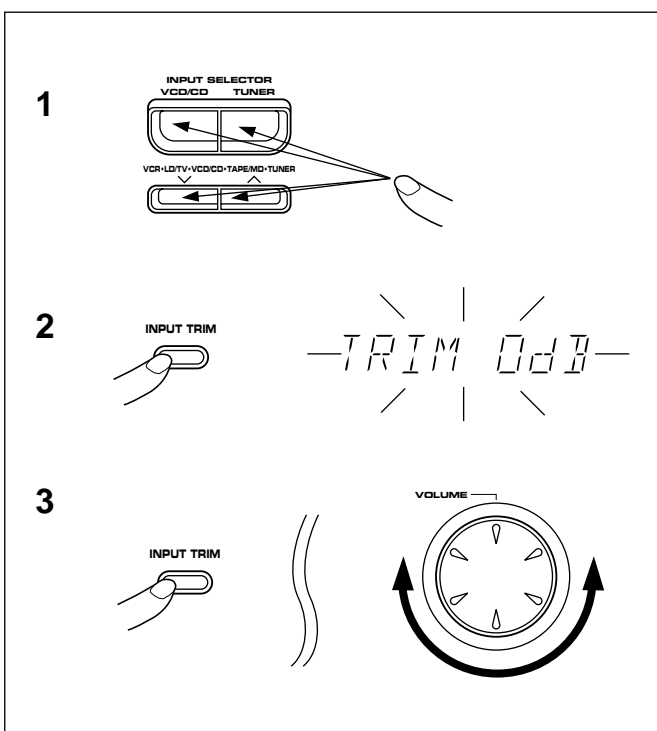

Adjusting input level of sources respectively

You can adjust input level of sources (the built-in Video CD player, tuner, and external units connected to this unit, for example tape deck and video cassette recorder).

(**Selectable values:** 0 dB, -3 dB, -6 dB, -9 dB)

- 1 Select a source whose input level you will adjust by using the INPUT SELECTOR buttons, and then play back the source. (For source playback, refer to pages 18 to 33).
- 2 Press and hold the INPUT TRIM button for more than 2 seconds so that "TRIM" and the currently selected value appear on the display.
- 3 While holding the INPUT TRIM button down, change the value by turning the VOLUME control.
- 4 When you finish the adjustment, release the INPUT TRIM button. (The selected value is memorized by this operation.)
- 5 In the same way, adjust input level of other sources.

ADJUSTMENTS

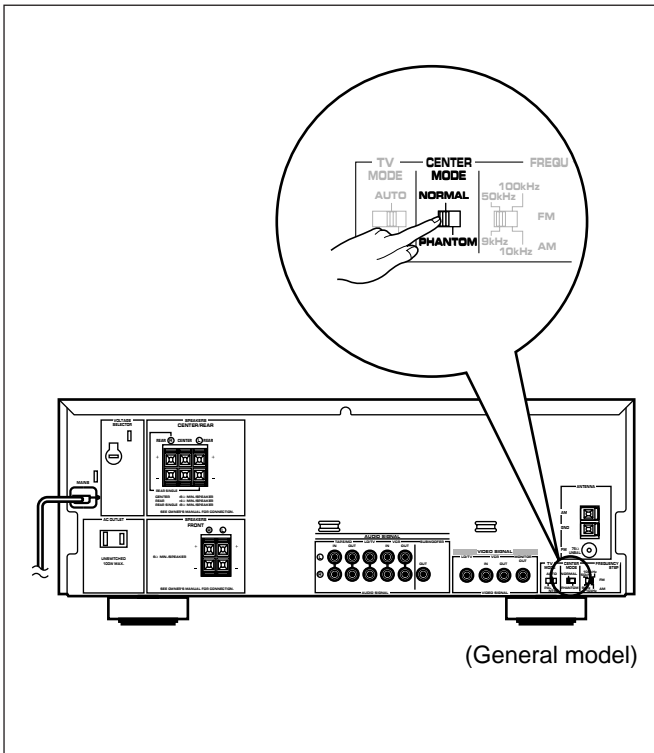

Speaker balance adjustment

This procedure lets you adjust the sound output level balance between the front, center, and rear speakers using the built-in test tone generator. When this adjustment is performed, the sound output level heard at the listening position will be the same from each speaker. This is important for the best performance of the built-in Dolby Pro Logic surround decoder. **The adjustment of each speaker output level should be done at your listening position with the remote control transmitter. Otherwise, the result may not be satisfactory.**

Before operation

Set the CENTER MODE switch on the rear panel of this unit to the position suitable for your speaker system configuration. (Refer to page 7 for details.)

NORMAL (For 5-speaker configuration):

Select this position when you use the center speaker.

PHANTOM (For 4-speaker configuration):

Select this position when you do not use the center speaker. The center sound will be output from the left and right front speakers.

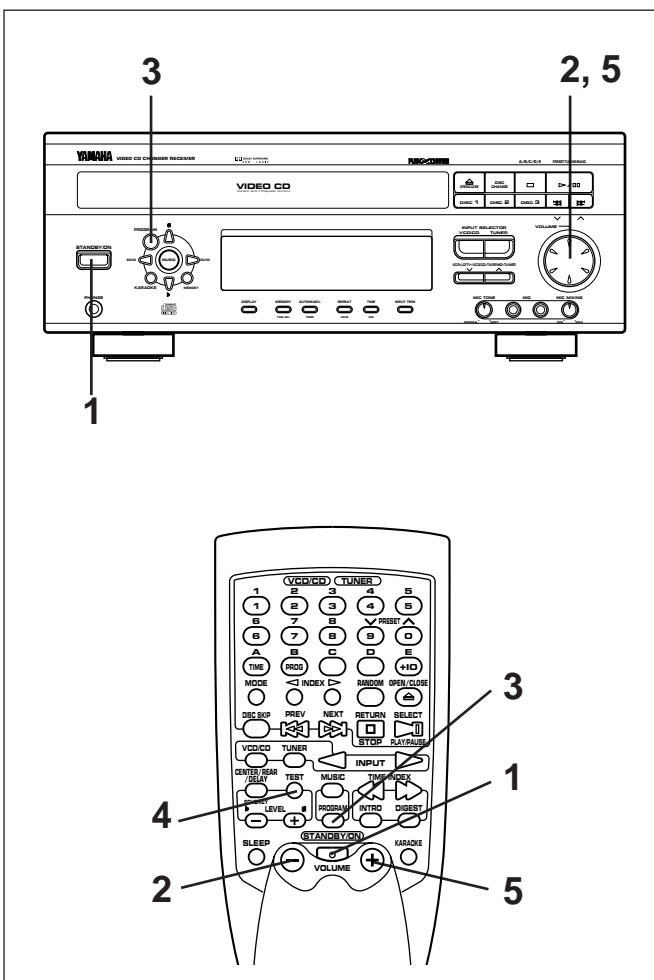

- 1 Press the STANDBY/ON switch to turn the power on.
- 2 Turn the VOLUME control counterclockwise to decrease the volume to minimum.
- 3 Press the PROGRAM button once or more so that "PRO LOGIC" lights up on the sound field program indicator.
- 4 Press the TEST button.
* "TEST" flashes on and off on the display.
- 5 Press the VOLUME + (up) button to increase the volume.

You will hear a test tone (like pink noise) from the left front speaker, then the center speaker, then the right front speaker, and then the rear speakers, for about two seconds each. The display changes as shown below.

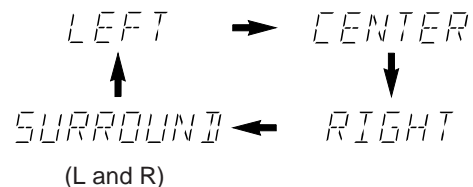

- * The test tone from the left rear speaker and the right rear speaker will be heard at the same time.

ADJUSTMENTS

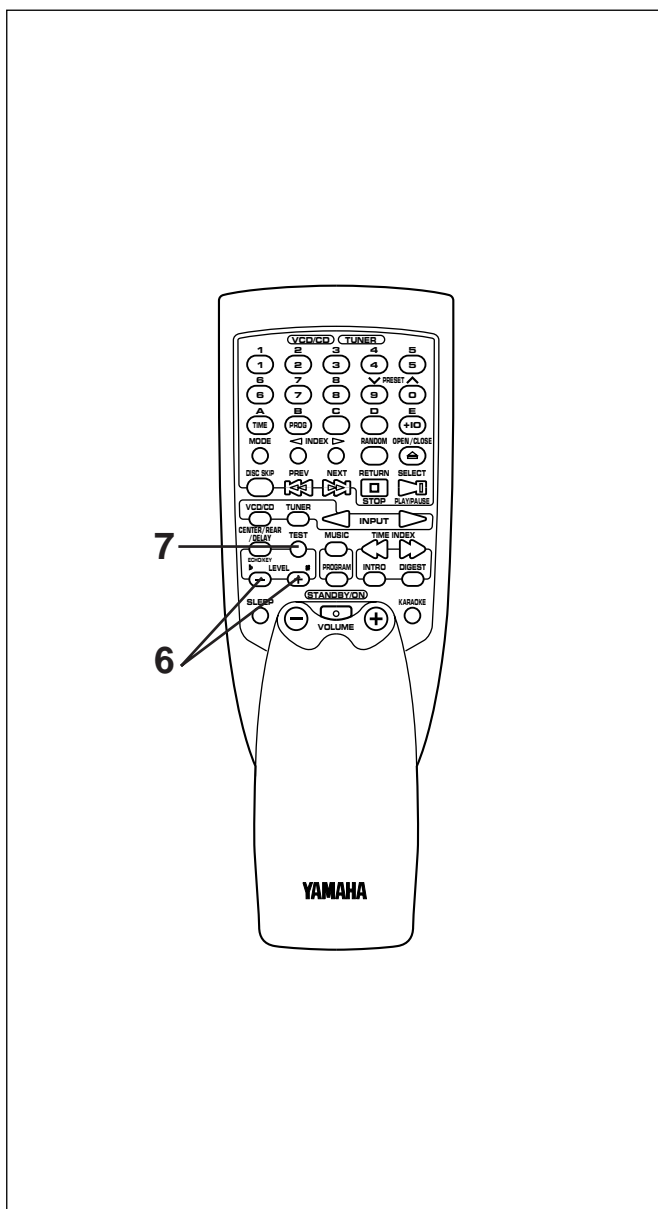

6 Adjust the sound output levels of the center speaker and the rear speakers by using the LEVEL control buttons so that they become almost as same as that of the front speakers.

- When the test tone is output from the center speaker, pressing the LEVEL control buttons change the output level of the center speaker.

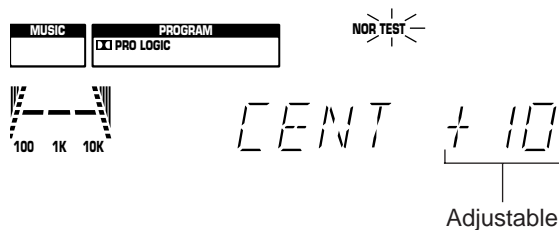

- When the test tone is output from the rear speakers, pressing the LEVEL control buttons change the output level of the rear speakers.

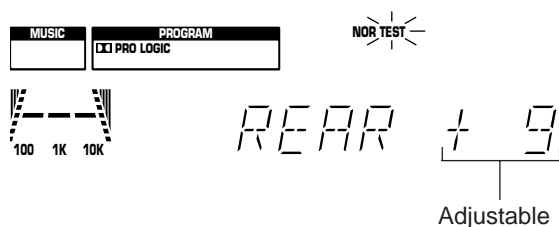

- * Pressing the + button raises and the – button lowers the level.

7 If the adjustments are finished, press the TEST button to cancel the test tone.

- * "TEST" disappears from the display.

Notes

- Once you have completed these adjustments, you can adjust whole sound level on your audio system by using the VOLUME control (or the VOLUME keys on the remote control transmitter) only.
- In step 6, if the center channel mode is in the "PHANTOM" position, the sound output level of the center speaker cannot be adjusted. This is because in this mode, the center sound is automatically output from the left and right front speakers.



VIDEO CD PLAYER OPERATION

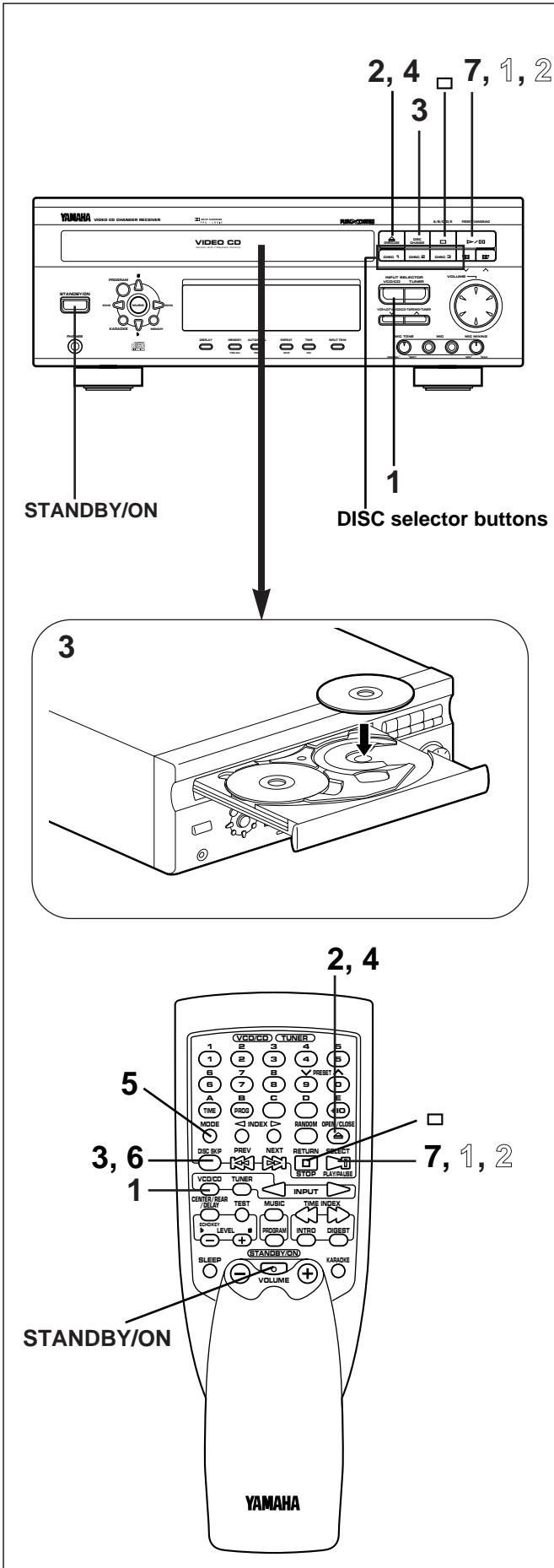

The procedures on this section (from page 18 to 26) are ineffective when this unit is in the Playback Control mode. For information about the Playback Control operation of Video CDs, version 2.0, refer to pages 27–29.

CD/Video CD playback

* If you play back a Video CD, turn on the monitor TV connected to this unit.

- 1 Select the Video CD player by pressing the VCD/CD INPUT SELECTOR button so that "VCD/CD" appears on the display.
- 2 Press the OPEN/CLOSE button to open the disc table.
- 3 Place discs on the trays, label side up.
 - * Up to three discs can be loaded on the trays. To load the third disc, rotate the disc table by pressing the DISC CHANGE button on the front panel or the DISC SKIP button on the remote control transmitter.
 - * 8 cm (3") discs may be played without an adaptor.
- 4 Press the OPEN/CLOSE button to close the disc table.
 - * The total number of tracks and the total playing time of the disc being selected will be displayed for several seconds.
 - * The music calendar will be displayed only for the number of tracks on the disc being selected.
 - * If the disc contains more than 15 tracks, the "OVER" indicator will light up on the music calendar.
 - * If the selected disc is a Video CD, "VCD" lights up on the display.

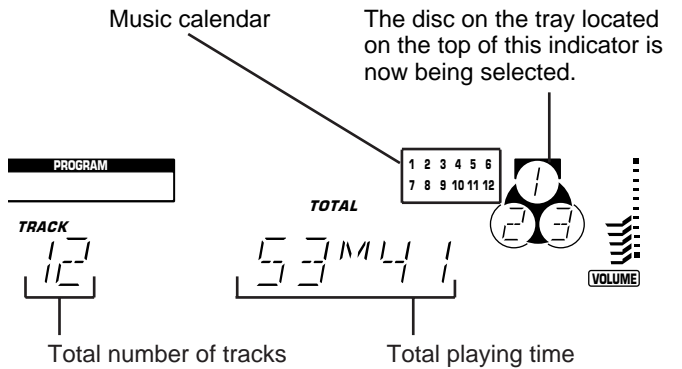

- 5 If necessary, change the disc play mode by pressing the disc play MODE selector button on the remote control transmitter watching the display.

Single disc play mode: Only a designated disc is played back.
All disc play mode: All discs on the disc table are played back sequentially.

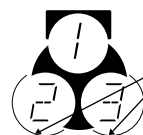

Lights up only when the all disc play mode is selected.



VIDEO CD PLAYER OPERATION

- 6** If necessary, select another disc by pressing the DISC SKIP button on the remote control transmitter once or more (so that the corresponding disc tray number is located on the top of the disc indicator).
- 7** Press the play/pause ▷/⏸ button to start playback from track 1.
- * The “▷” indicator will appear and playback will begin. As the playback of each track on the music calendar is finished, that track number will go out.

For easier operation

Pressing the DISC selector button (1, 2 or 3) will select the disc directly, and playback will begin from track 1 automatically

Note

If a Video CD, version 2.0 is selected, “PBC” lights up on the display, yet the total number of tracks, the total playing time of the disc and the music calendar will not be displayed. In this mode, disc playback is controlled by the rule of Playback Control. (For details of Playback Control, refer to page 27–29.)

To cancel this mode and restore the normal playback mode, press the RETURN (□) button on the remote control transmitter. “PBC” disappears from the display.

To call the Playback Control mode again, press and hold the RETURN (□) button on the remote control transmitter for more than 2 seconds.

To interrupt playback

- 1 Press the play/pause ▷/⏸ button.
* The “▷” indicator will flash.
- 2 Press the play/pause ▷/⏸ button to resume playback from the same point.

To stop playback

Press the stop □ button.

To turn the unit into the standby mode after use

Turn this unit into the standby mode by pressing the STANDBY/ON switch. (The indicators will go off except for the current time display.)

Direct playback

When this unit is in the standby mode, pressing the DISC selector (1, 2 or 3) button will turn the power on and start disc playback automatically.

When the power is on, even if an input source other than Video CD player is selected, pressing a DISC selector button or closing the disc table by pushing the front edge of the disc table gently will start playback directly.

* These ways of playback can also be used to close the disc table. If the table is closed in these ways, playback will begin automatically, however, the display will not show the total number of tracks and the total playing time of the disc to be played back.

Direct operation

When this unit is in the standby mode, pressing the following buttons will turn the power on and perform their own functions automatically.

On the front panel: OPEN/CLOSE, DISC (1, 2, 3),
INPUT SELECTOR (VCD/CD, TUNER)

On the remote control transmitter:
OPEN/CLOSE, VCD/CD, TUNER,
PLAY/PAUSE

PLAYXCHANGE

During playback, you can open the disc table by pressing the DISC CHANGE button without interrupting playback. However, in this case, pressing the DISC SKIP button or a DISC selector button is invalid.

Note

You can load or replace discs on the trays when the disc table is opening, however, never load a disc on the tray hidden inside the unit. In doing so, the disc and the unit may be damaged, because the tray already has a disc, which is being played back.

Precautions

- Subjecting the unit to shock or vibration can cause mistracking.
- Playing back some discs at high volume can cause mistracking. In this case, listen at lower volume.
- Do not pull open the disc table forcibly with your hands.
- Do not push the disc table while it is moving.
- If the power fails while the table is open, wait until the power supply returns or gently push the table manually to close it.
- The temperature range for playing back discs is recommended to be 5°C (41°F) – 35°C (95°F).



VIDEO CD PLAYER OPERATION

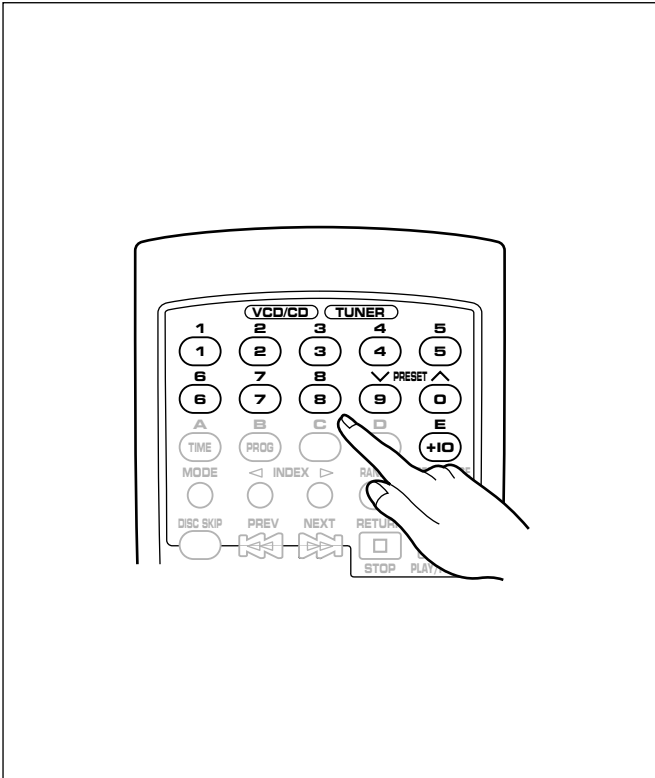

Direct-selection playback

By using the track number input buttons on the remote control transmitter, any track you wish to listen to can be played back directly.

Use the track number input buttons to select the desired track number. Playback will begin automatically.

A. For example, to choose selection 5

Press the "5" button.

B. For example, to choose selection 12

- (1) Press the "+10" button.
- (2) Within a few seconds, press "2" button.

C. For example, to choose selection 20

- (1) Press the "+10" button.
- (2) Within a few seconds, press the "+10" button again.
- (3) Within a few seconds, press the "0" button.

Note

If you select a track number higher than the number of tracks on the disc, only the last track of the disc may be played back.

"Skip search" and "Manual search" are performed using the same buttons.

To play back a desired track on the disc (Skip search)

The beginning of any track can be found automatically.

- 1 Select a disc and begin playback.
- 2 Press the $\triangleright\triangleright$ button to advance or $\triangleleft\triangleleft$ button to reverse through the disc. Press once for each track to be advanced or reversed.
 - Press $\triangleright\triangleright$ once to advance to the track following the one now playing back.
 - Press $\triangleleft\triangleleft$ once to return to the start of the track now playing back.
 - Press $\triangleleft\triangleleft$ twice to return to the track before the track now playing back.

Notes

- This function can also be performed while the Video CD player is stopped. Press the play/pause \triangleright/\square button when your desired track number appears on the track number display. Playback will begin from the beginning of the track.
- This function will be performed forward or backward from any point on the disc. However, it will not move forward during playback of the final track.

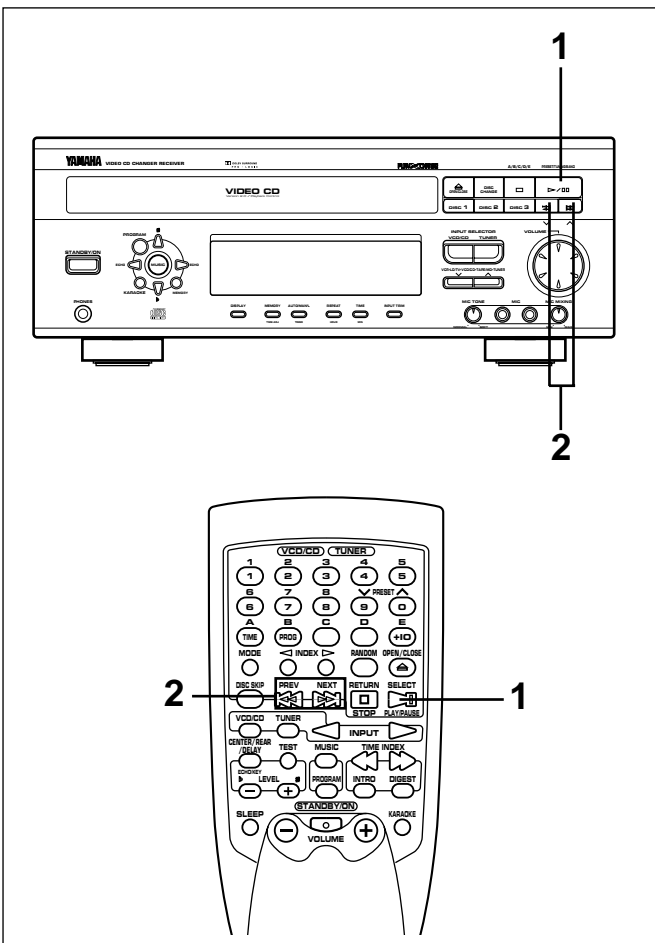



VIDEO CD PLAYER OPERATION

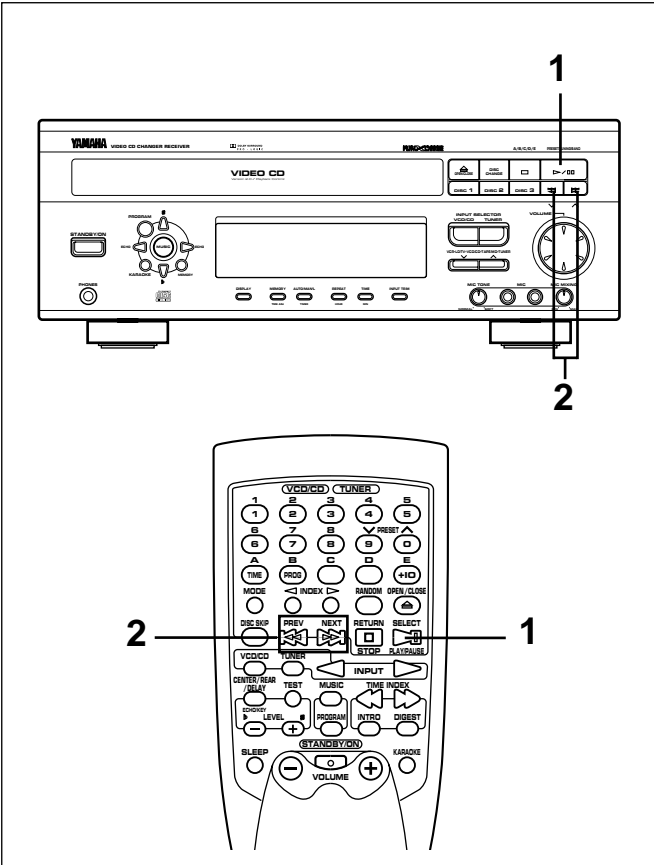

To advance or reverse playback rapidly (Manual search)

- 1 Begin playback.
- 2 Press and hold the button to advance playback rapidly, and the button to reverse playback rapidly.
 - * The sound can be heard (although slightly garbled) during manual search in either direction. This is convenient for reviewing the contents quickly.

Note
Manual search can also be performed while playback is paused, though no sound will be heard.

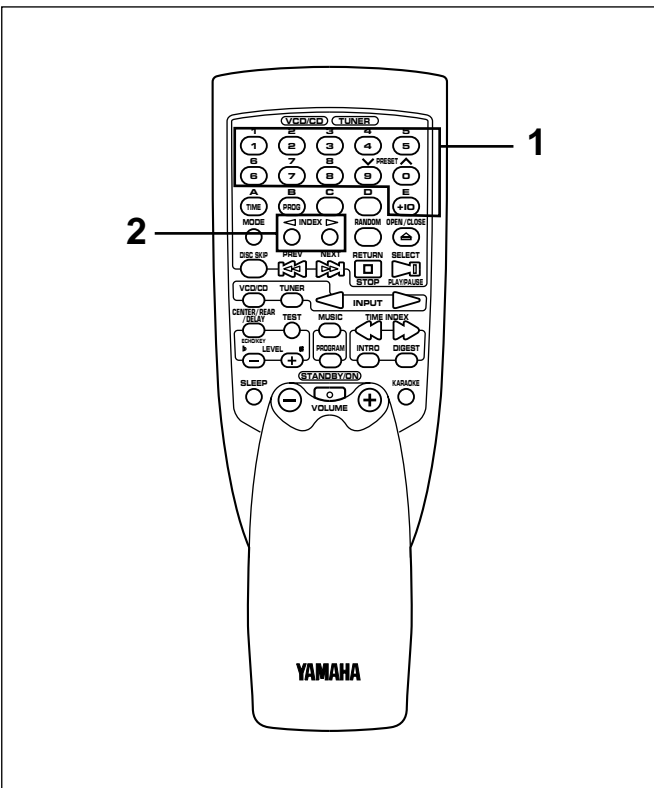

Index search

If the currently selected disc includes index numbers, playback can be started from any desired index number.

- 1 Select a track which has index numbers by using the track number input buttons.
- 2 Pressing the INDEX or button once or more searches for and select any index number. Play starts from the point of selected index number.

Notes

- If you select an index number that is higher than the highest index number of the disc, the highest index number's part of the disc may be played back.
- If the disc has no encoded index points, playback will begin from the start of the selected track.



VIDEO CD PLAYER OPERATION

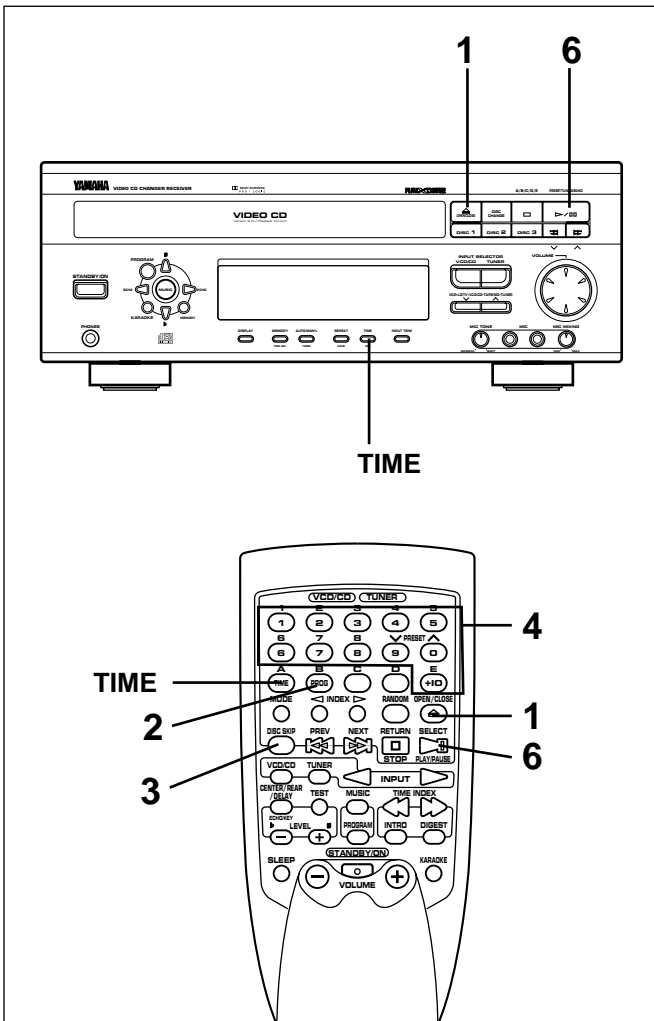

Program play

You can program up to 20 tracks in any desired order.

- 1** Load discs and close the disc table.
- 2** When in the stop mode, press the PROG button to prepare for programming.
 - * "PROG" and "P-01" will light up on the display, and all track numbers on the selected disc will begin flashing.
- 3** If necessary, select a desired disc by pressing the DISC SKIP button.
 - * Just after you change the disc, this unit reads the contents of the newly selected disc for a few seconds. During this internal operation, if you go on to the next step, "WAIT" appears on the display and your operation is canceled.
- 4** Use the track number input buttons to select the desired track number.
 - * The selected track number and the total play time of the programmed tracks will light up on the display, and soon it will be replaced by the display of the next playback order. Programmed track numbers on the selected disc will stop flashing and light up on the music calendar.
 - * Pressing the TIME button displays the total play time of the programmed tracks for about 1 second, and then it is replaced by the display of the next playback order.
 - * **For example, to choose selection 12**
 - (1) Press the "+10" button.
 - (2) Within 3 seconds, press the "2" button.
- 5** Repeat steps 3 and 4 for any other track. Up to 20 tracks can be programmed.
- 6** Press the play/pause button to start playback of programmed tracks.

Display information during programming

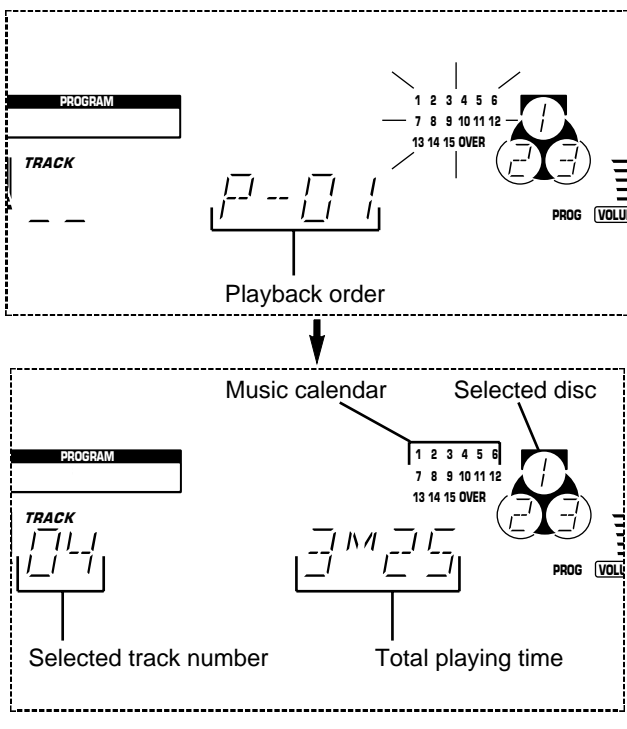

Notes

- When this unit is in the Playback Control mode ("PBC" is illuminated on the display) and the playback is stopped, pressing the PROG button cancels the Playback Control mode, and so you can make programming operations.
- It is also possible to program a sequence of tracks while looking at the list of tracks on the surface of the disc before closing the disc table.
- During playback or pause, programming is not possible.
- If the total time of the programmed tracks becomes 100 minutes or more, the highest position of the figure will not be displayed.
- The total time of the programmed tracks will not be displayed, if track number 16 or higher is programmed.
- Skip search can be performed during playback, but only within the range of the programmed tracks.
- Manual search can be performed during playback to search all tracks, including unprogrammed tracks.
- If programs are made selecting tracks from more than one disc, pressing the DISC CHANGE button is useless during program play.



VIDEO CD PLAYER OPERATION

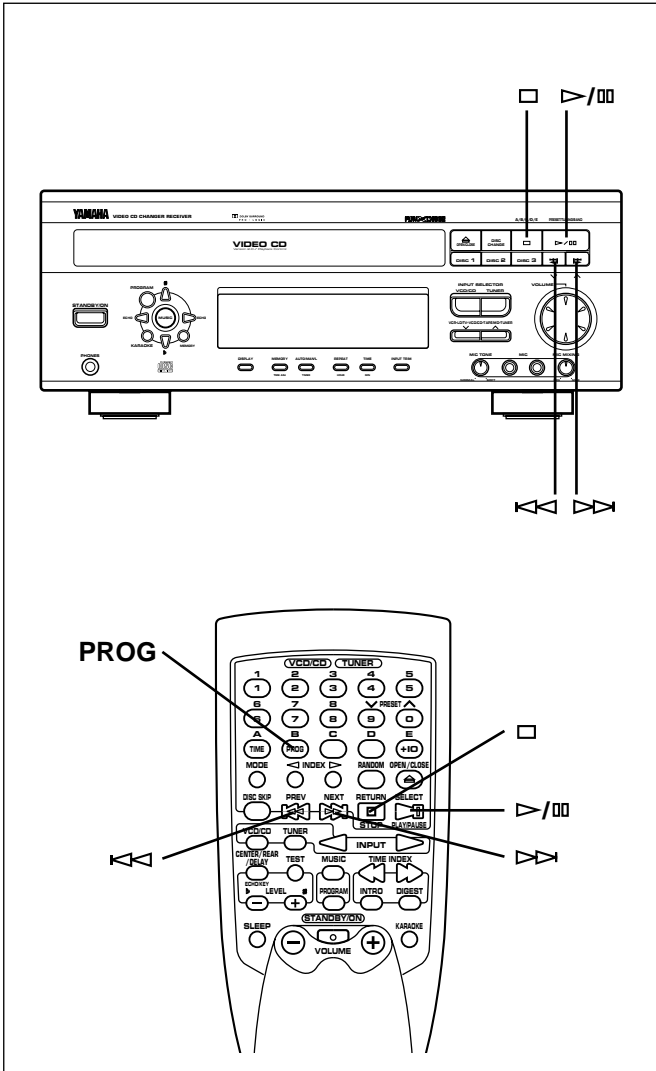

To stop program play

- Press the stop □ button. The first programmed track number will be displayed.
- To resume playback, press the play/pause ▷/⏸ button. Playback will begin from the beginning of the program.

To cancel a programmed sequence

There are several methods as described below.

- Press the stop □ button while the unit is stopped.
- Open the disc table
- Turn this unit into the standby mode.

To check program data

1. If during playing back, press the stop □ button.
2. Press the PROG button.
3. Each time the ▷▷ button is pressed, the track numbers and sequential order of the programmed tracks can be checked one after another. The display of the track number can be returned (sequentially in reverse order) by pressing the ◀◀ button.

To correct program data

1. Follow the procedure described in "To check program data".
2. Display the track number to be corrected by pressing the ▷▷ or ◀◀ button.
3. Press a track number input button to select a track to replace the one displayed. The previously programmed track will be cleared from the memory and the new one will be programmed.
4. When the correction is finished, press the PROG button or play/pause ▷/⏸ button once again.

Random play

Tracks on a selected disc or all discs on the disc table can be played back in a random order.

- 1 Load discs and close the disc table.
- 2 If necessary, switch the disc play mode by pressing the disc play MODE selector button.
 - * If the single disc play mode is selected, select a desired disc by pressing the DISC SKIP button.
- 3 Press the RANDOM button to begin random play.
 - * The "RANDOM" indicator will light up.

To cancel the random play

Press the stop □ button, or press the RANDOM button again. The "RANDOM" indicator will go out.

Notes

- This feature will not function during programming or program play.
- The RANDOM button can work when this unit is in the Playback Control mode and stopped. In this state, pressing the RANDOM button cancels the Playback Control mode.

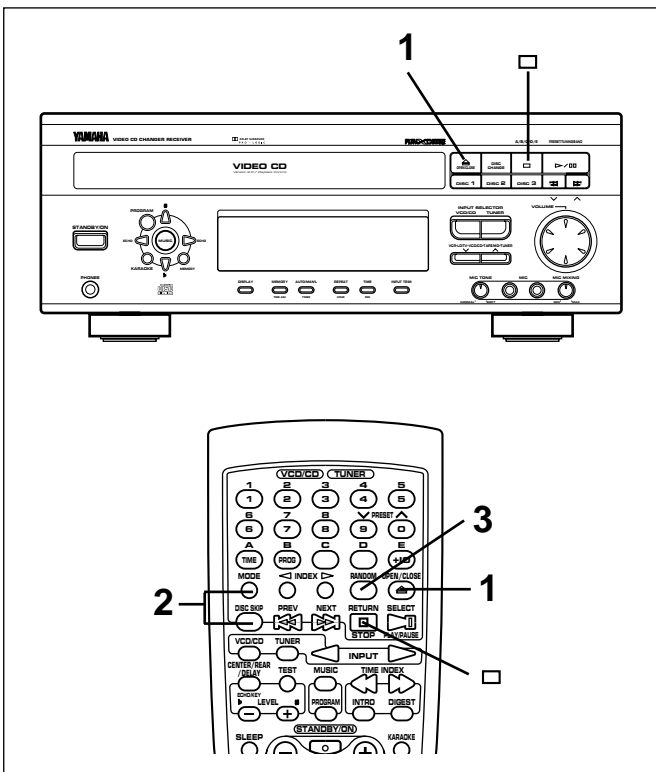



VIDEO CD PLAYER OPERATION

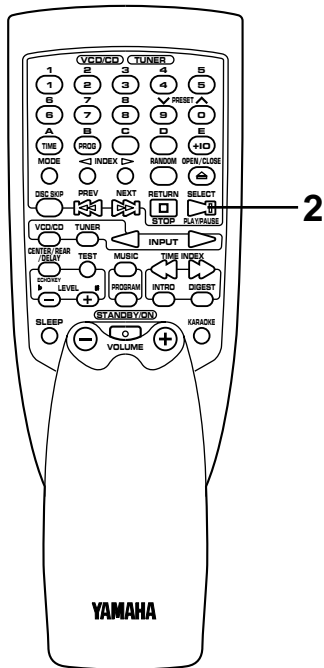
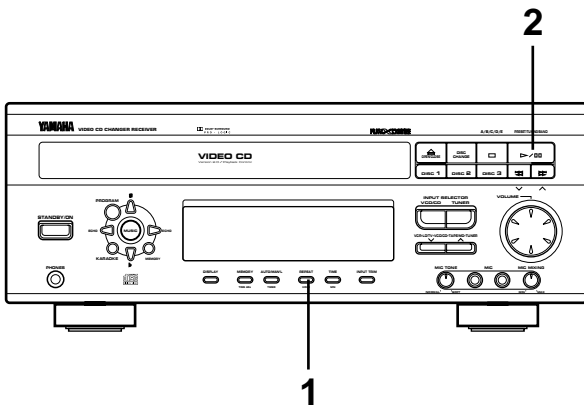

Repeat play

All discs, an entire disc, a single track or a programmed sequence can be continuously repeated.

- 1 While watching the display, press the REPEAT button once or more to select a desired repeat play mode (S REP or F REP).
- 2 Press the play/pause $\blacktriangleright / \square$ button.

Repeat play modes

SINGLE REPEAT (S REP)

A single track is played back repeatedly.

* This is also available in the program play mode and the random play mode. (If the repeat play mode is switched off, the program play mode or the random play mode will be resumed.)

FULL REPEAT (F REP)

When the unit is in the single disc play mode:

A designated disc is played back repeatedly.

* In the random play mode, the selected disc is repeatedly played back, but the order of tracks is different every time.

When the unit is in the all disc play mode:

All discs on the disc table are played back repeatedly.

* In the random play mode, the random play is performed among all discs and repeated with a different order of tracks every time.

Notes

- In the program play mode, a sequence of programmed tracks is played back repeatedly.
- When this unit is in the Playback Control mode ("PBC" is illuminated on the display), no repeat play mode can be selected.

To cancel the repeat play

Press the REPEAT button once or more so that the (S, F) REP indicator goes out.



VIDEO CD PLAYER OPERATION

Switching the time display

Each time the TIME button is pressed, the display will change as described below.

[Example]

When the second track is being played back (Refer to the illustration on the left.)

- ① The elapsed play time for the track now playing back will be displayed.
* 8 seconds have passed since the beginning of the second track.
- ② The remaining play time for the current track will be displayed.
* 2 minutes and 58 seconds remain till the end of the second track.
- ③ The total play time of the disc will be displayed.
(If the unit is in the program play mode, the total play time of the programmed tracks will be displayed.)
- ④ The total remaining play time from the point being played at that time will be displayed.
* 41 minutes remain till the end of the disc.

Notes

- During random play, the total remaining play time on the disc will not be displayed.
- The remaining play time will not be displayed for track number 16 or higher.
If a program play is performed and the programs include a track number 16 or higher, the total play time and the total remaining play time will not be displayed, either.
- When this unit is in the Playback Control mode ("PBC" is illuminated on the display), the currently selected time display mode cannot be changed to another.

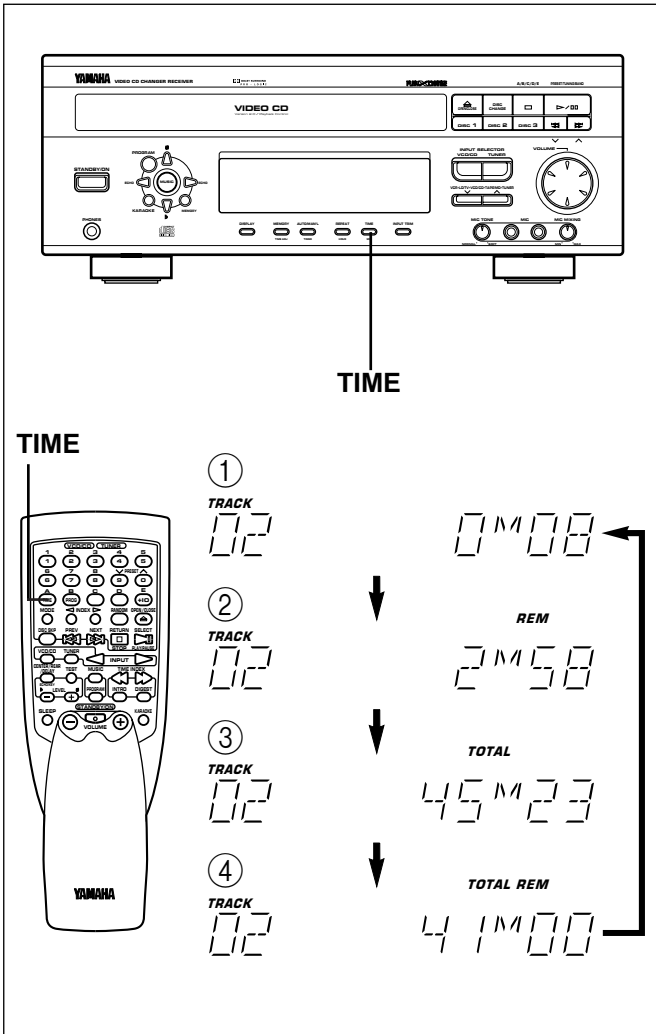



VIDEO CD PLAYER OPERATION

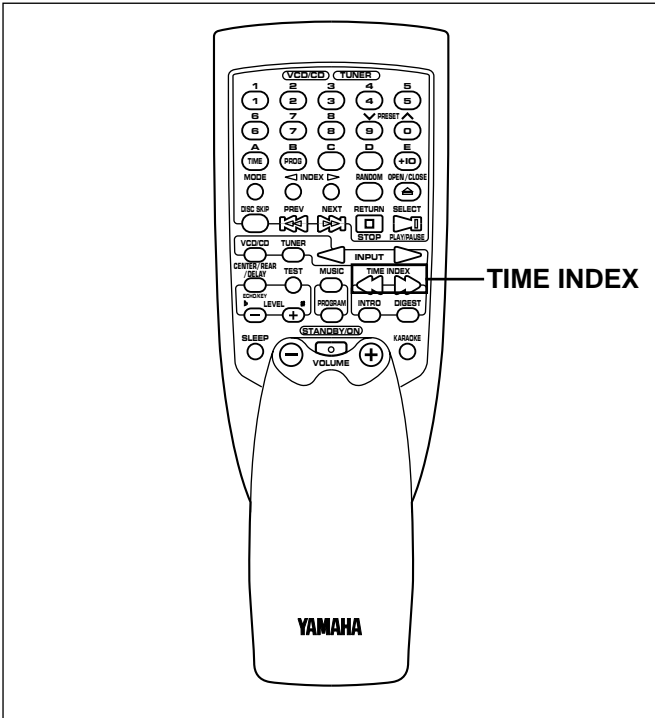

To skip through tracks or an entire disc forward or backward (for Video CDs only)

Pressing the TIME INDEX ◀ or ▶ button once allows you to skip through the track forward or backward respectively by the time shown on the display.

Every time you press a button repeatedly, the skipping time changes and is shown on the display. Releasing the button makes the Video CD player skip forward or backward by the displayed time. The skip operation varies as follows:

- While you are playing back a disc, you can skip forward or backward through the entire disc.
- While you are playing back a Video CD, version 2.0 in the Playback Control mode, you can skip forward or backward through the selected track.

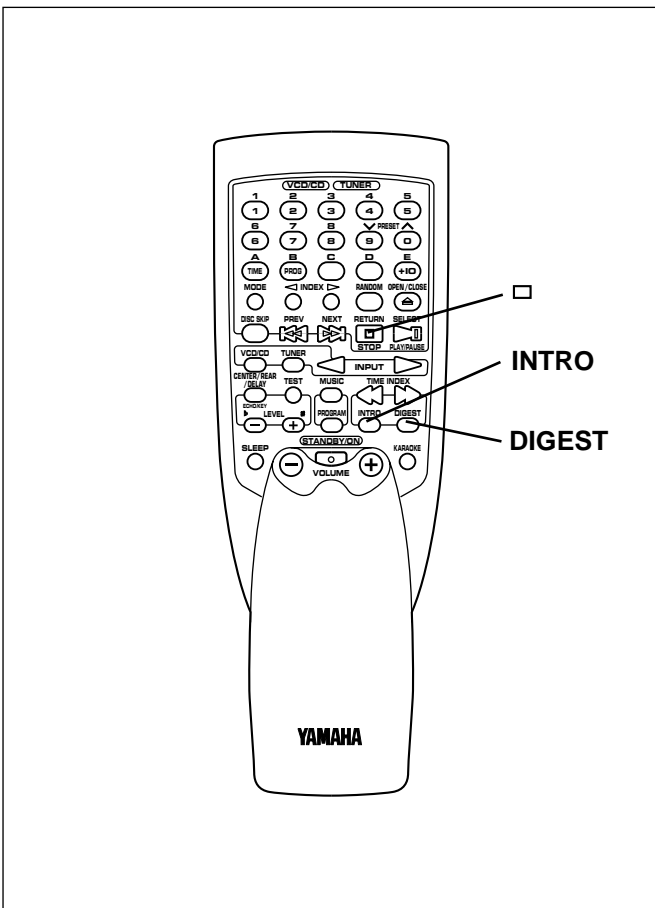

To get a quick overview of a track or a disc (for Video CDs only)

To watch scenes of a selected track on a Video CD

Press the DIGEST button.

To watch the beginning of all tracks on a Video CD

Press the INTRO button.

* You can watch up to nine screens at a time on the video monitor.

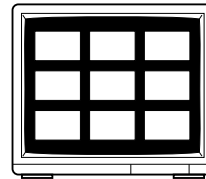

Notes

- These buttons can work only for playing back a Video CD.
- These buttons cannot work when playing back a Video CD, version 2.0 in the Playback Control mode. To make these buttons work, press and hold the stop □ button for more than 2 seconds to stop this unit.
- These DIGEST and INTRO operations repeat endlessly until you stop playback.
- These button cannot work in the program play and random play modes.
- The monitor can show up to nine screens at a time. The number of screens varies from disc to disc. There may be a case that the monitor can show one screen only as shown below.

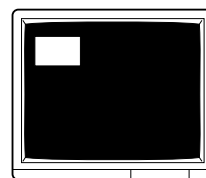

To cancel DIGEST and INTRO operations

Press the stop □ button.



PLAYBACK CONTROL OF VIDEO CD (Ver. 2.0)

This function is available for Video CDs, version 2.0 only. "PBC" will light up on the display when a version 2.0 disc is used. The Playback Control differs with each disc. This section gives a basic explanation of Playback Control. Refer to the instruction manual for the disc for details.

Playback Control provides you with two types of new playback enjoyment.

Playback selection on a screen menu

You can select pictures, music and information to play back by selecting items on a screen menu. (Similar to having a conversation.)

Playback of high quality pictures

You can enjoy watching pictures which are four times as high in quality as moving pictures.

A Flowchart of Playback Control (as an example)

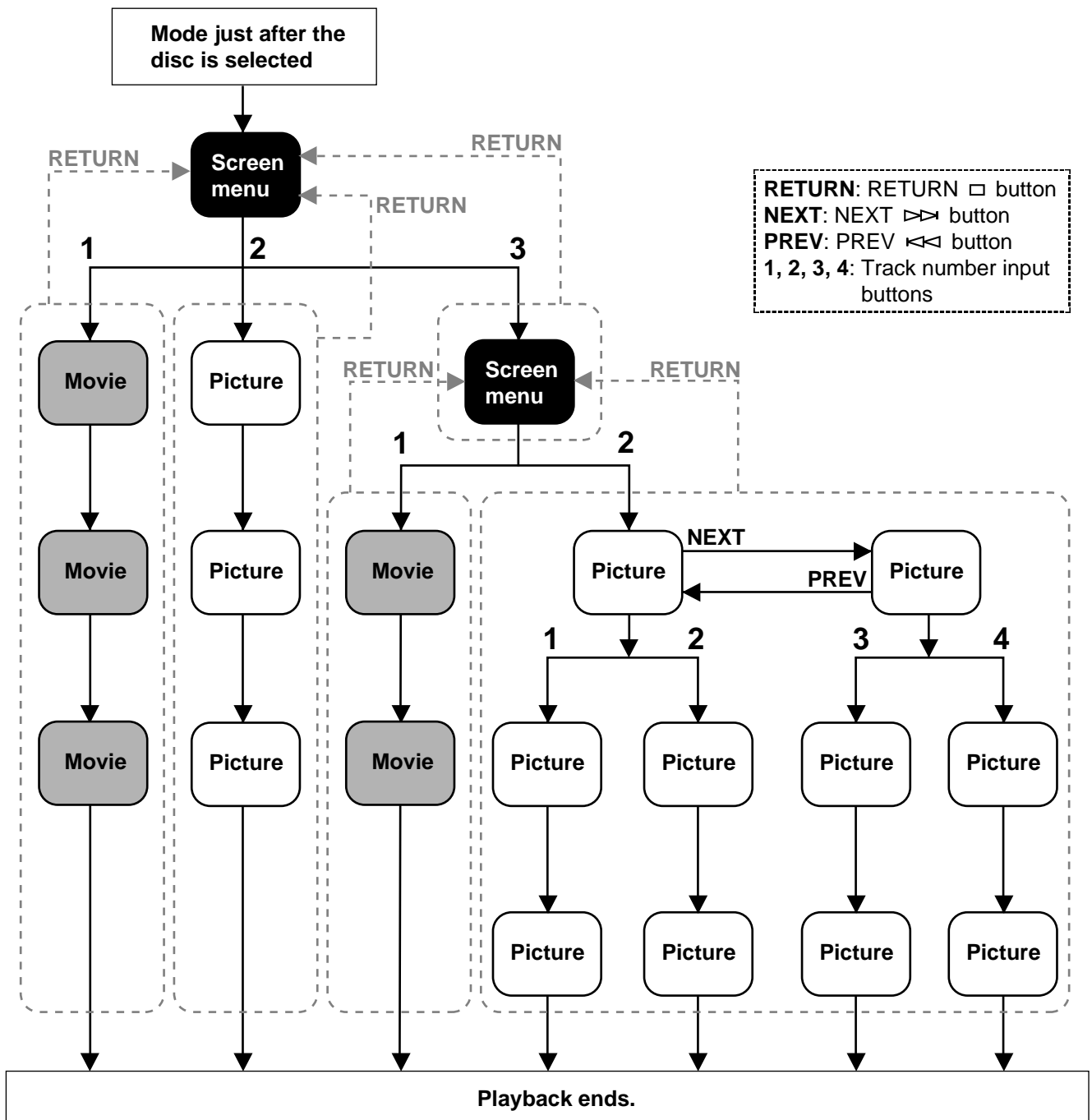



PLAYBACK CONTROL OF VIDEO CD (Ver. 2.0)

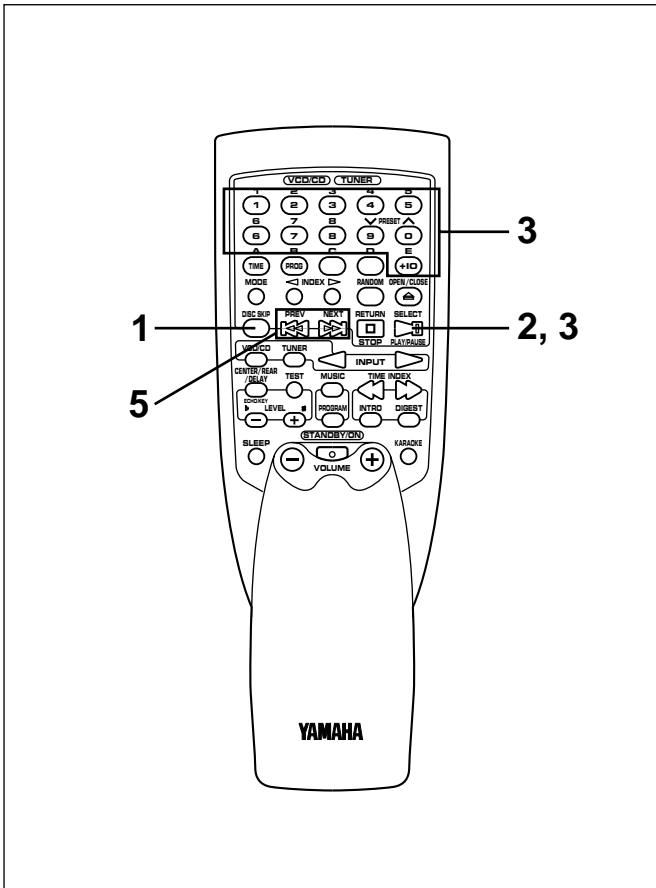

Basic operation

Use the remote control transmitter for making Playback Control operations.

Note

Disc playback in the Playback Control mode depends on the data of the disc used. So, the following operations may not be able to be applied to some discs.

Be sure to refer to the instruction manual for the disc.

- 1 Stop this unit and select a Video CD (version 2.0) by pressing the DISC SKIP button on the remote control transmitter .
* "PBC" lights up on the display.
- 2 Press the SELECT button. A screen menu appears on the TV monitor.
* Some discs show several short movies sequentially instead of a menu.
- 3 Select the number of item you want to play back by using the track number input buttons.
* If the disc shows several short movies sequentially, press the SELECT button when a desired picture appears.
- 4 Playback starts, or another menu appears. If another menu appears, repeat step 3.
(Some discs have more than one screen menu.)
- 5 If "NEXT" or "▶▶" appears on the screen during playback, pressing the NEXT button will change to the next menu.

If "PREV" or "◀◀" appears on the screen during playback, pressing the PREV button will restore the previous menu.

Notes

- In the Playback Control mode, the TIME and REPEAT buttons are disabled.
- The PROG, RANDOM, DIGEST and INTRO buttons can work when this unit is in the Playback Control mode and stopped. In this state, pressing one of these buttons cancels the Playback Control mode.



PLAYBACK CONTROL OF VIDEO CD (Ver. 2.0)

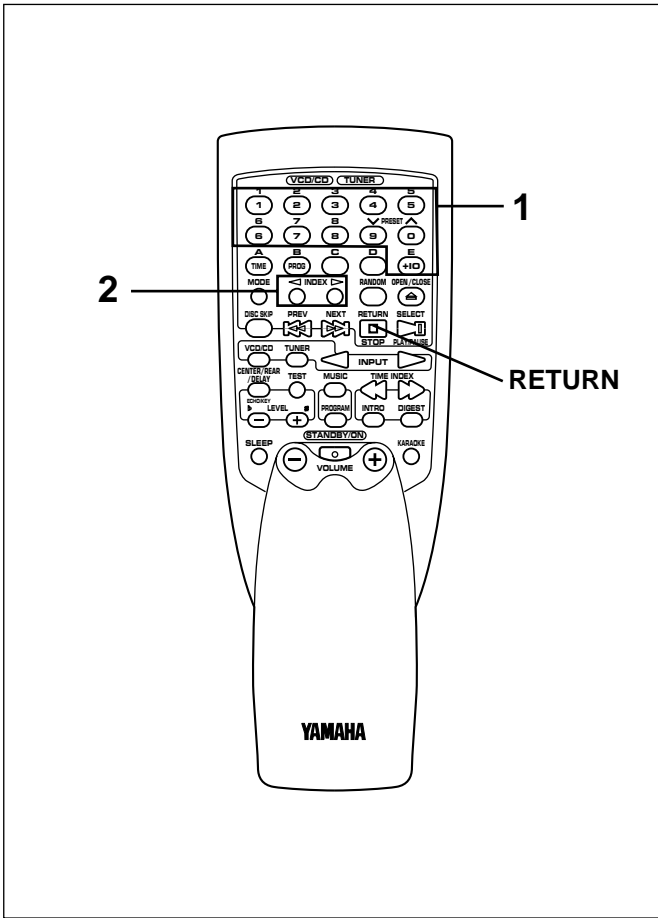

To stop playback

Press and hold the RETURN button for more than 2 seconds.

To return to a previous screen mode during playback

Press the RETURN button once.

* To return to the first screen mode, press the RETURN button repeatedly until the first screen mode appears.

If the disc has index numbers

If the currently selected disc includes index numbers, playback can be started from any desired index number.

- 1 Select a track which has index numbers by using the track number input buttons.
- 2 Pressing the INDEX \triangleleft or \triangleright button once or more searches for and selects any index number. Play starts from the point of selected index number.

To playback a Video CD (ver. 2.0) without Playback Control operation

Press the RETURN button when this unit is stopped. "PBC" disappears from the display, and this unit turns into a normal playback mode.

To restore the Playback Control mode again, press and hold the RETURN button for more than 2 seconds.



TUNING OPERATION

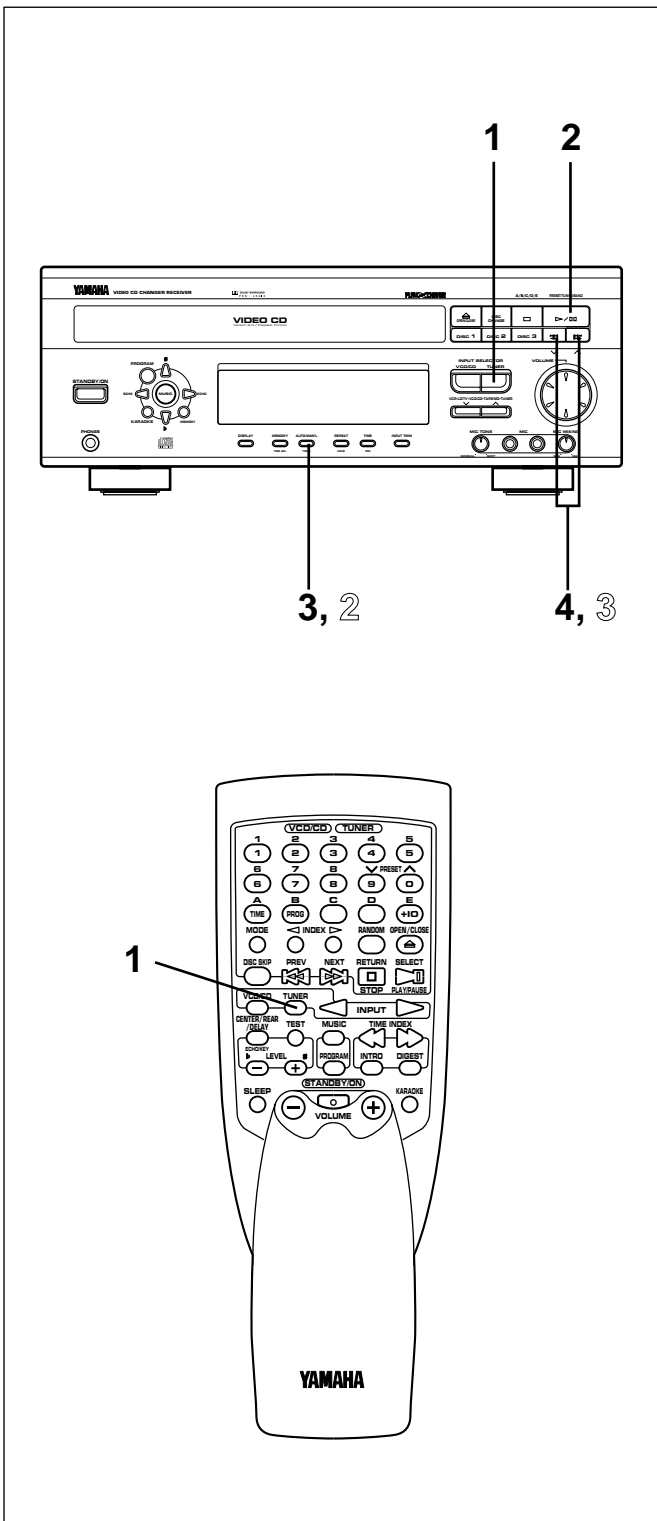

Normally, if station signals are strong and there is no interference, quick automatic-search tuning (Automatic tuning) is possible. However, if signals of the station you want to select are weak, you must tune to it manually (Manual tuning).

Automatic tuning

- 1 Select the tuner by pressing the TUNER INPUT SELECTOR button so that "TUNER" appears on the display.
- 2 Select the reception band (FM or AM) by pressing the PRESET/TUNING/BAND button confirming it on the display.
 - * Do not select a preset tuning mode (in which "PRESET" lights up on the display.)
- 3 Press the AUTO/MAN'L button so that "AUTO" lights up on the display. (In this mode, stations are received in stereo or monaural automatically.)
- 4 Press the ^ button to tune to a higher frequency, or press the v button to tune to a lower frequency. (When tuned in to a station, "TUNED" will light up on the display.)
- 5 If the station where tuning search stopped is not the desired one, follow step 4 again.

- * If the tuning search does not stop at the desired station, change to the Manual tuning method as described below.
- * STEREO indicator will light up when an FM stereo broadcast with sufficient signal strength is received.

Manual tuning

- 1 Follow steps 1 and 2 of the Automatic tuning method.
- 2 Press the AUTO/MAN'L button so that "AUTO" disappears from the display. (In this mode, stations are received in monaural.)
- 3 Press and hold the ^ button to tune to a higher frequency, or press and hold the v button to tune to a lower frequency. Release it just before reaching the desired frequency, and then press it repeatedly until the desired frequency appears. (When tuned in to a station, "TUNED" will light up on the display.)

Note

If you tune in to an FM station manually, it is received in monaural automatically to increase the signal quality.

Note

Pressing the TUNER input selector button on the remote control transmitter switches the tuner from FM to AM mode and vice versa.

TUNING OPERATION

Manual preset tuning

This unit can store station frequencies selected by tuning operation. With this function, you can select any desired station only by calling the corresponding preset station number. Up to 40 stations (8 stations x 5 groups) can be stored.

To store stations

(Example: To store a station to A1)

- 1 Tune in to a desired station.
(Refer to the previous page for tuning procedure.)
- 2 Press the tuner MEMORY button.
* "MEMORY" and "PRESET" will flash on the display for about 5 seconds.
- 3 Select a desired group (A – E) of preset stations by pressing the A/B/C/D/E button confirming it on the display, before "MEMORY" goes out.
(In this case, select group A.)
- 4 Select a preset station number by pressing the \vee or \wedge button repeatedly before "MEMORY" goes out.
(In this case, select "1".)
- 5 Within about 5 seconds, press the tuner MEMORY button again.

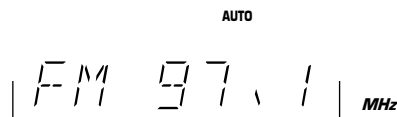

The currently displayed station has been programmed to A1.

- * In the same way, program other stations to A2, A3 ... A8.
- * You can program more stations to the preset station numbers of other groups in the same way by selecting other groups in step 3.

To recall a preset station

- 1 Select a group of preset stations by pressing the A/B/C/D/E button.
- 2 Select the desired preset station number by pressing the \vee or \wedge button repeatedly.

Notes

- A new setting can be programmed in place of the former one.
- For presets the setting of the AUTO/MAN'L button is stored along with the station frequency.

For easier operation

By using the preset station number buttons and the A,B,C,D,E selector buttons on the remote control transmitter, a preset station number and a group can be selected directly.

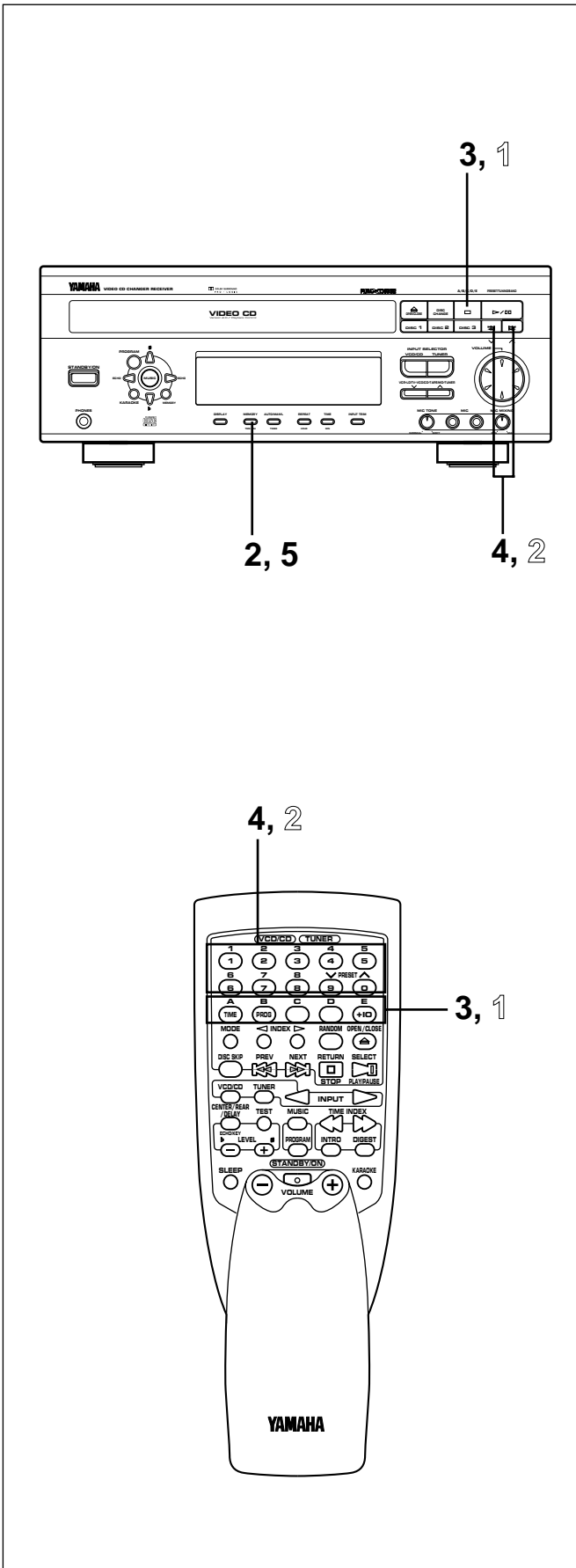



TUNING OPERATION

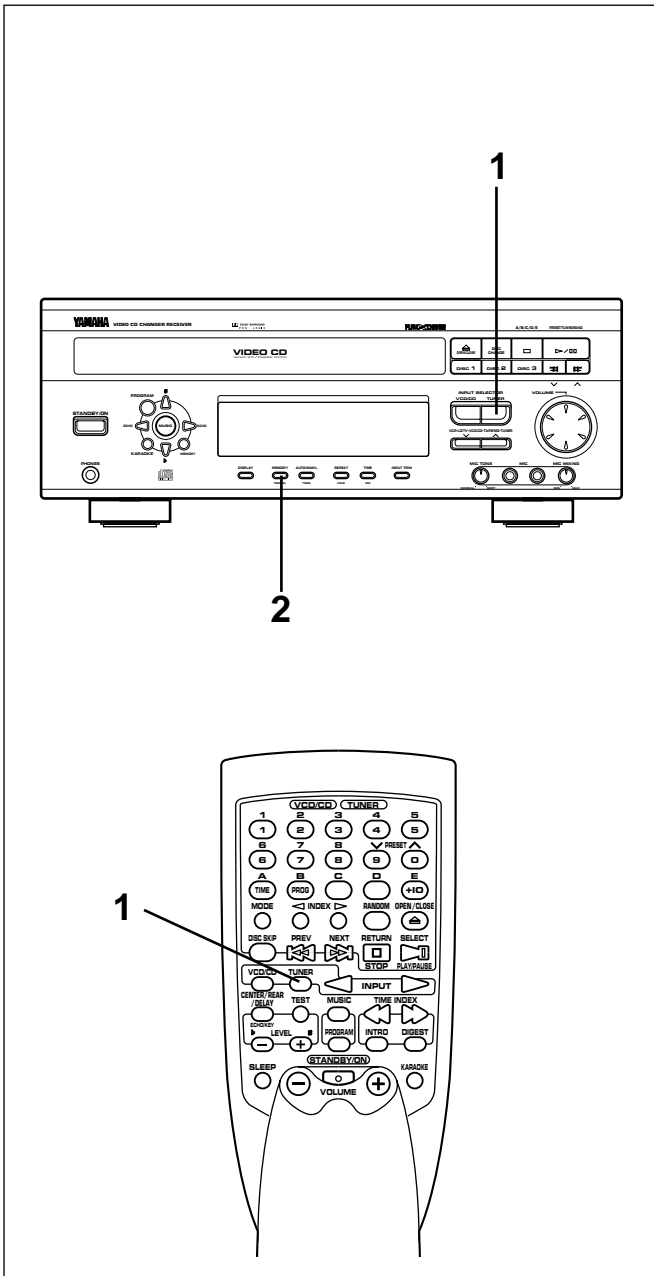

Automatic preset tuning

You can make use of an automatic preset tuning function. With this function, this unit performs automatic tuning and stores stations with strong signals sequentially. Up to 40 stations are stored automatically in the same way as in the manual preset tuning method on the previous page.

- 1 Select the tuner by pressing the TUNER INPUT SELECTOR button so that "TUNER" appears on the display.
- 2 Press and hold the tuner MEMORY button for more than 2 seconds.
 - * The MEMORY and AUTO indicators flash.

This unit performs automatic tuning and searches FM and AM stations in that order. Received stations are programmed to A1, A2 ... A8 sequentially.

When the automatic preset tuning is completed;

The display shows the frequencies of the first preset station (stored to A1).

Check the contents and the number of preset stations by following the procedure of the section "To recall a preset station" on the previous page.

To recall a preset station

Simply follow the procedure of the section "To recall a preset station" on the previous page.

Notes

- The automatic preset tuning search will be performed through all frequencies until 40 stations are stored. If the number of received stations is less than 40, the search will stop after searching all frequencies.
 - * Since FM stations are searched for first, there may be a case that 40 preset stations are occupied by FM stations only.
- With this function, only stations with sufficient signal strength are stored automatically. If the station you want to program is weak in signal strength, tune in to it with the Manual tuning method (in monaural) and program it by following the procedure of the section "To store stations" on the previous page.
- You can replace a preset station with another FM or AM station manually by simply following the procedure of the section "To store stations" on the previous page.

Memory back-up

The memory back-up circuit prevents the programmed data from being lost even if the AC supply lead is disconnected from the AC outlet or the power is cut due to temporary power failure. If, however, the power is cut for more than one week, the memory may be erased. If so, it can be re-programmed by simply following the preset tuning steps.

OPERATING EXTERNAL UNITS CONNECTED WITH THIS UNIT

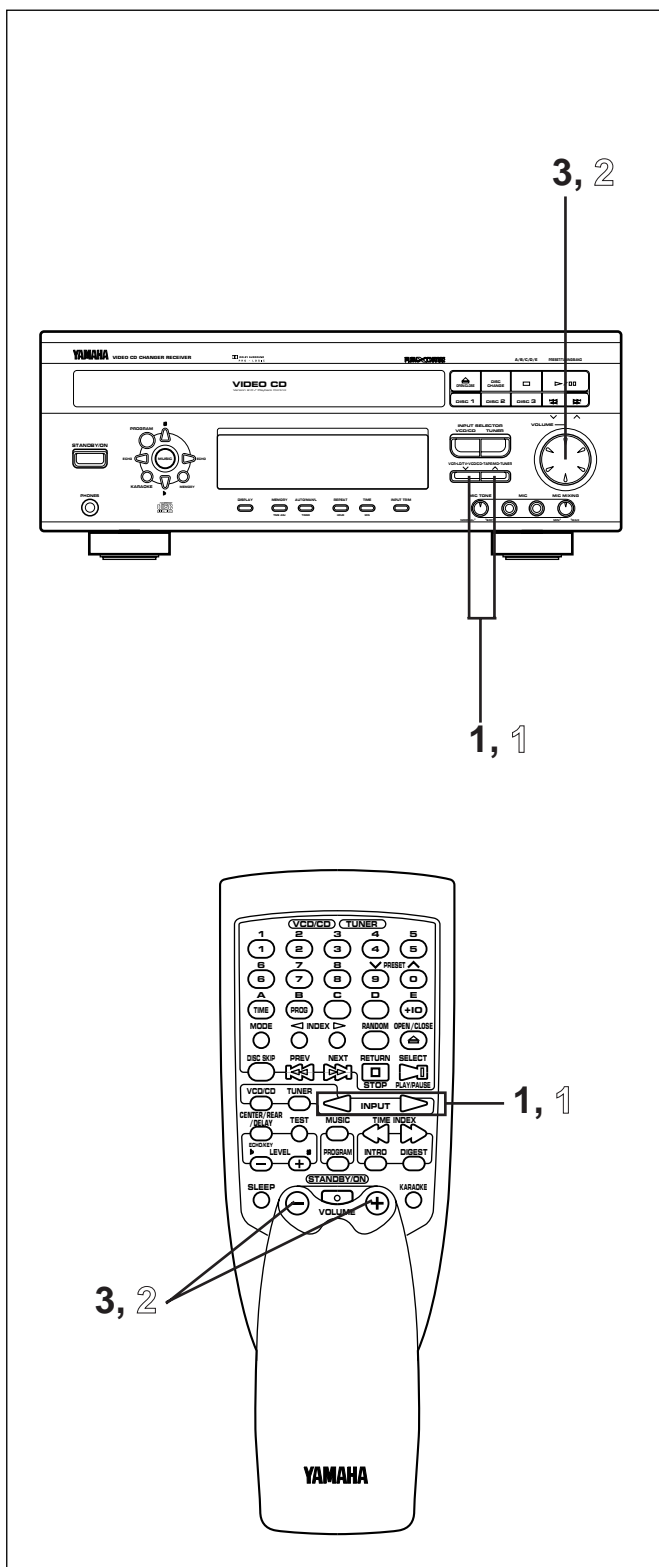

To listen to or watch a source on an external unit connected with this unit

- 1 Select the position of input source (VCR, LD/TV or TAPE/MD) you will play back by pressing the INPUT SELECTOR \vee or \wedge button until the corresponding name appears on the display.
 - * The names of input sources correspond with the names of terminals to connect with external units on the rear of this unit.
- 2 Play back the source.
(For a video source, turn on the monitor TV.)
- 3 Adjust the volume to a desired level by using the VOLUME control.
If you prefer, use the graphic equalizer and/or the sound field processor built into this unit.

To record a source to tape

Not only a source played back on this unit, but also a source played back on an external unit can be recorded by the tape deck, VCR, MD recorder, etc. connected with this unit.

- 1 Select the source you want to record by using the INPUT SELECTOR buttons.
- 2 Play back the source and then turn the VOLUME control up to confirm the input source.
- 3 Begin recording on the tape deck or VCR etc. connected with this unit.

Notes

- Only when a karaoke mode is selected and one or two microphone(s) are connected to this unit, you can record your vocal input from the microphone(s) along with the source onto a tape (or MD) by using the tape deck, VCR, etc. connected to the TAPE/MD OUT and/or VCR OUT terminals on the rear of this unit. (Refer to page 43 for details.)
- If the key level is changed when the built-in Video CD player is selected as the input source, sources are recorded with the key level changed.

USING GRAPHIC EQUALIZER

The built-in graphic equalizer presents you with the pleasure of listening to music with various sound effects. This unit provides 3 preset equalizer modes as listed right. You can enjoy listening to music with a desired sound effect by selecting one of these modes. In addition, the built-in 3 band graphic equalizer allows you to adjust the equalizer pattern to create an effect for your desired sound taste.

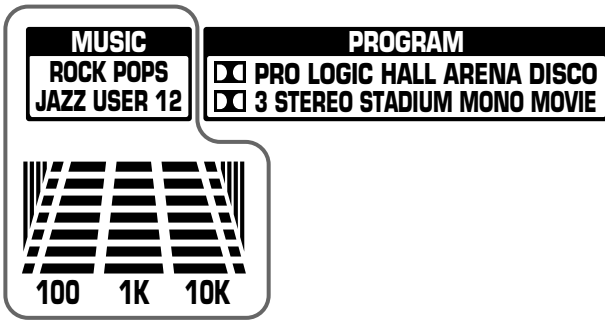

Preset graphic equalizer modes (MUSIC)

Mode	Feature
ROCK	High and low frequencies are emphasized. This mode is suitable for reproducing dynamic and powerful sounds of rock music etc.
POPS	Vocals are emphasized and whole sound is clear. This mode is suitable for pops.
JAZZ	High frequencies for piano, sax, etc. are emphasized. Medium frequencies for vocals are also emphasized moderately.
USER 1	These are for storing equalizer patterns of your own adjusting. (Refer to page 36 for the storing method.)
USER 2	

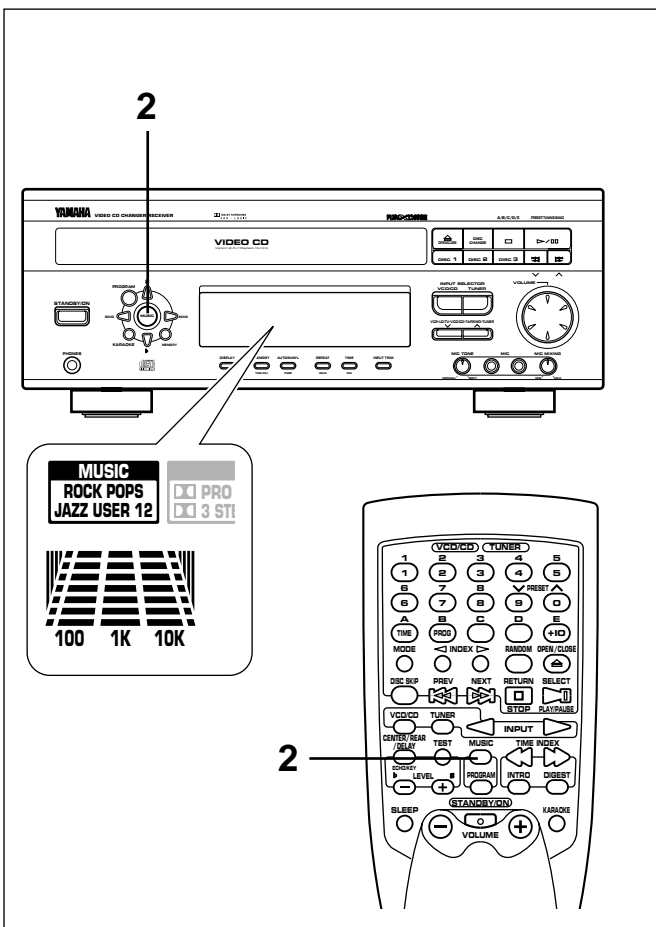

Listening to the music with a preset equalizer effect

- 1 Play back a source. (For source playback, refer to pages 18 to 33.)
- 2 Press the MUSIC button once or more so that the name of a desired mode appears on the preset equalizer mode indicator.
 - * Whenever you press the MUSIC button, the preset mode changes and is displayed as follows.

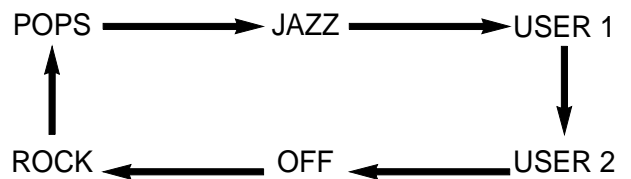

- * The equalizer pattern of the selected mode is shown on the graphic equalizer level indicators.
- * For details about "USER 1" and "USER 2", refer to page 36.

USING GRAPHIC EQUALIZER

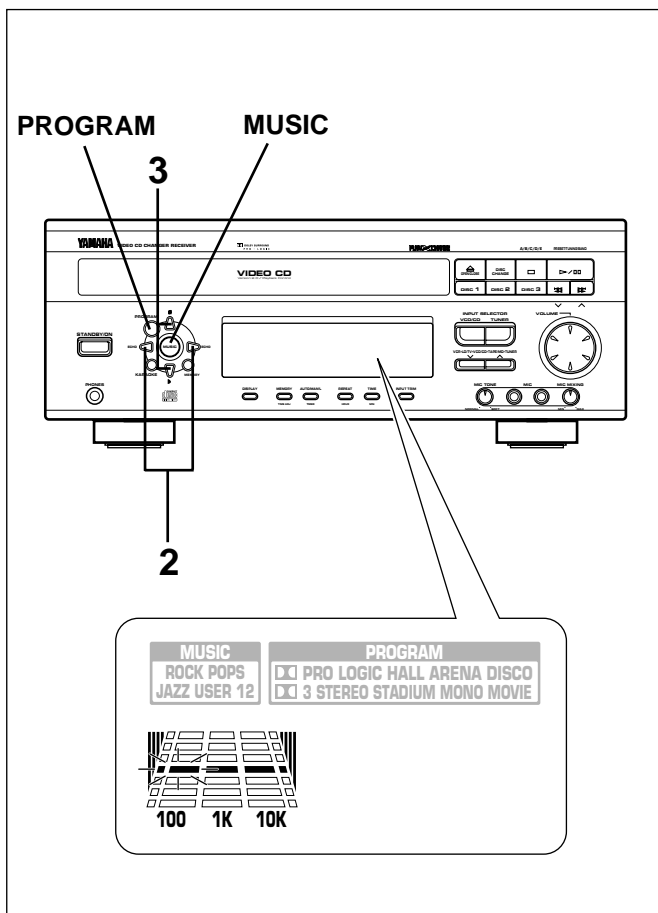

Adjusting the graphic equalizer for your desired sound taste

The 3 band graphic equalizer allows you to adjust the level for each frequency band.

* Make adjustment by monitoring the equalizer level indicators on the display.

- 1** Play back a source. (For source playback, refer to pages 18 to 33.)
- 2** Press the equalizer control ◀ or ▶ button once or more to select the frequency band to which you will adjust the level.
 - * The selected frequency band is shown on the display.
 - * The scale bar of the selected frequency band on the graphic equalizer level indicators will flash.
- 3** Press the equalizer control ▲ or ▼ button once or more to adjust the level.
 - * If a preset graphic equalizer mode is selected, its name goes off from the preset equalizer mode indicator (MUSIC) by this operation.
- 4** In the same way, make adjustment for other frequency bands.

Note

When a Karaoke mode is selected, the equalizer cannot be adjusted.

Turning the equalizer to “flat” (the state with no equalization applied)

Press the MUSIC button and the PROGRAM button on the front panel at the same time. The equalizer pattern is turned to “flat” and the selection of a sound field program is canceled.

USING GRAPHIC EQUALIZER

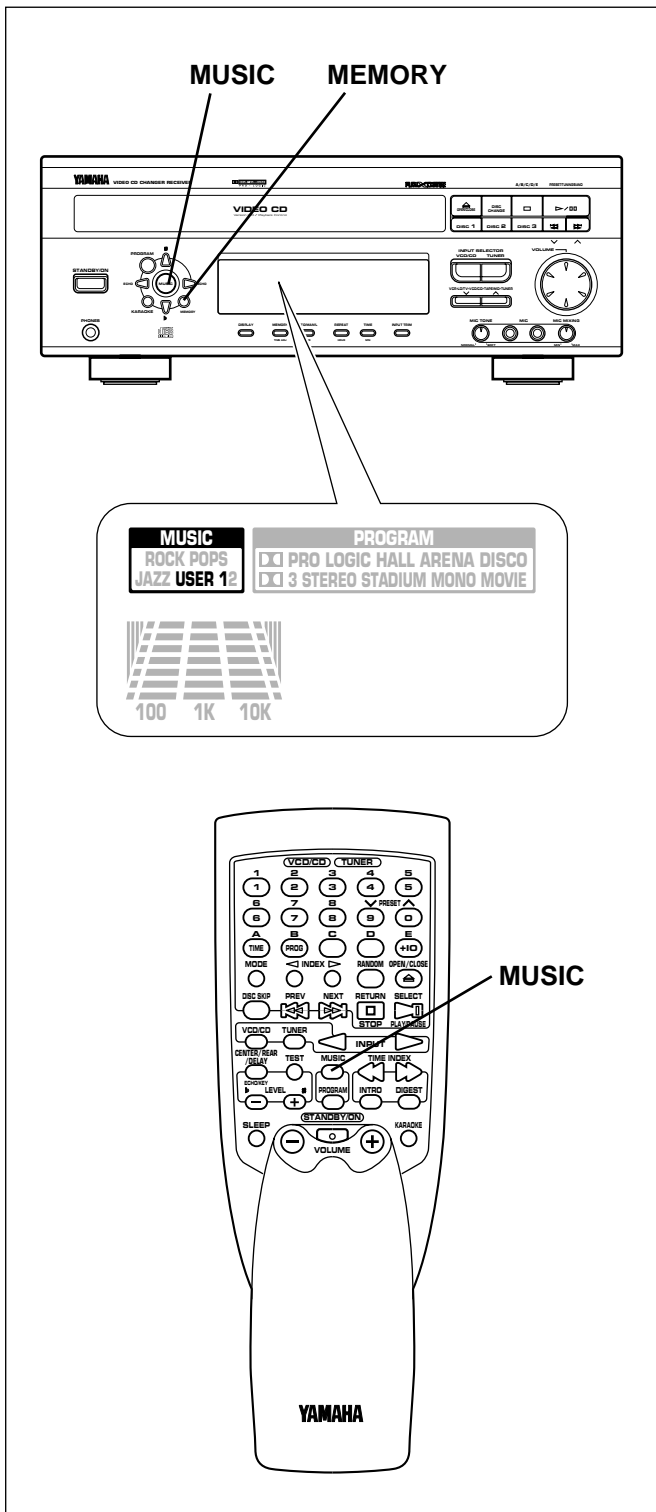

Storing your own equalizer patterns

An equalizer pattern of your own adjusting can be stored as a user preset mode. Two patterns can be stored as desired.

To store

- 1 Select a desired equalizer mode by pressing the MUSIC button and adjust the equalizer as you prefer by using the equalizer control buttons.
- 2 Press the user program MEMORY button.
 - * The MEMORY indicator and the equalizer pattern will flash for about 5 seconds. "USER 1" or "USER 2" appears on the display.
- 3 Select "USER 1" or "USER 2" to which you will store the selected equalizer pattern by pressing the MUSIC button once or more before the flashing indicators go off.
- 4 Press the user program MEMORY button before the flashing indicators go off. With this operation, a storing is completed.

* In the same way, store another pattern to the other user preset number.

Notes

- A new pattern can be stored in place of the former one.
- In step 3 or 4, if the flashing indicators go off before operation, return to step 2.

To recall a user program

- 1 Play back a source. (For source playback, refer to pages 18 to 33.)
- 2 Press the MUSIC button once or more so that the user preset number (USER 1 or USER 2) you want to recall lights up.

USING SOUND FIELD PROCESSOR

The Sound Field Processor built into this unit presents you with the ambience of an actual concert hall etc. by adding effects as sonic reflections or reverbations that create the sound environment of a hall etc. This unit provides preset sound field programs shown below. You can enjoy an excellent audio sound field by selecting one of them, and adding desired adjustments.

This unit incorporates a Dolby Pro Logic Surround decoder for multi-channel sound reproduction of Dolby Surround encoded video sources. The operation of the Dolby Pro Logic Surround decoder can be controlled by selecting a corresponding sound field program.



Brief Overview of Sound Field Programs

PROGRAM	FEATURE
<input checked="" type="checkbox"/> PRO LOGIC	This program is used for playback of sources encoded with Dolby Surround. Sounds are reproduced as movie creators designed by using five speakers. You can experience the dramatic realism and impact of a movie theater.
<input checked="" type="checkbox"/> 3 STEREO	This program is effective not only for playback of sources encoded with Dolby Surround, but also for sources not encoded with Dolby Surround or TV programs with 2-channel stereo sound. With this program, 2-channel stereo sound is converted into 3-channels (left front, center and right front), so the dialogs are emphasized on the center position by the use of the center speaker. As no sound is output from the rear speakers, this program is also effective in a simple Audio/Video system without rear speakers.
HALL	In this program, the center will appear to be deep behind the front speakers, creating an expansive large hall ambience. Orchestra and opera music is suited for this sound field.
ARENA	This program simulates the sound environment of a big hall with long reverberation time and many reflections of high frequencies.
DISCO	This program recreates the acoustic environment of a lively disco in the heart of a very lively city. The sound is dense and highly concentrated. It is also characterized by a high-energy, "immediate" sound.
STADIUM	This program gives you long delays between direct sounds and effect sounds, and extraordinarily spacious feel of a large stadium.
MONO MOVIE	This program is designed specifically to enhance mono source programs. Compared to a strictly mono setting, the sound image created in this mode is wider and slightly forward of the speaker pair, lending an immediacy to the overall sound. It is particularly effective when used with old mono movies, news broadcasts and dialog.

USING SOUND FIELD PROCESSOR

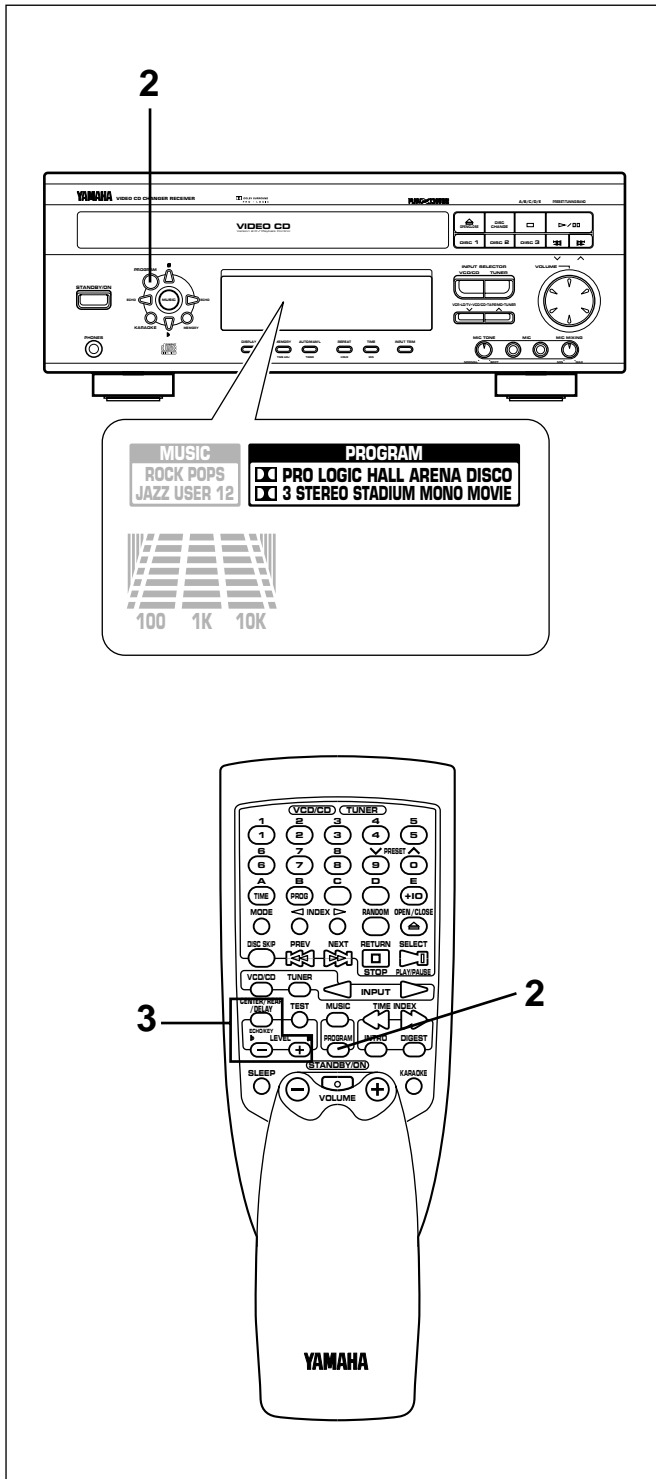

Listening to the music with a sound field effect

- 1 Play back a source. (For source playback, refer to pages 18 to 33.)
- 2 Press the PROGRAM button once or more so that the name of a desired program lights up on the sound field program indicator.
* Whenever you press the PROGRAM button, the program changes and is displayed as follows.

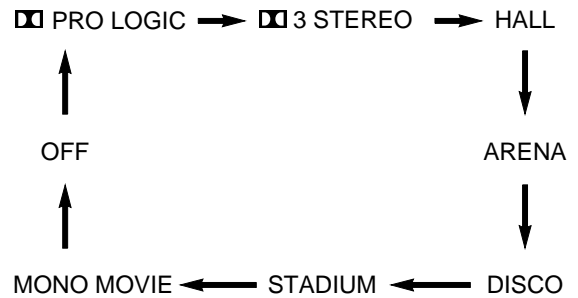

- 3 If desired, adjust the delay time and the output level of each speaker. (For details, refer to the corresponding descriptions on pages 39 to 40.)

Notes

- When HALL, ARENA, DISCO, STADIUM or MONO MOVIE is selected, no sound is heard from the center speaker.
- When a monaural sound source is played with PRO LOGIC, no sound is heard from the rear speakers.
- If you play back a source not encoded with the Dolby Pro Logic Surround when PRO LOGIC is selected, the source may not be played back normally.
- A sound field program and a karaoke mode cannot work simultaneously. If you press the KARAOKE button to select a karaoke mode, the sound field processor becomes unavailable. (The sound field program indicator on the display goes off.)

Reversely, if you select a sound field program by pressing the PROGRAM button once or more, the karaoke mode becomes unavailable.

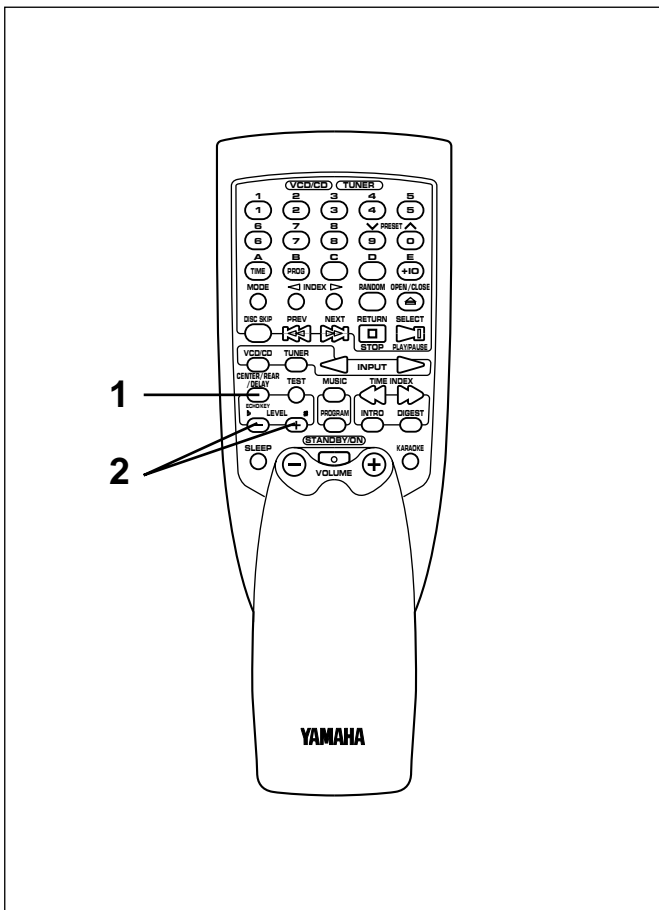

Adjusting CENTER LEVEL

If desired, you can adjust the sound output level of the center speaker even if the output level is already set in “**Speaker balance adjustment**” on pages 16 to 17.

Control range : +10 to –20

- 1 Press the CENTER/REAR/DELAY selector button once or more so that “CENT” appears on the display.
- 2 By continuously pressing the LEVEL control + or – button, the level value changes continuously.

Notes

- This adjustment can be made only when the sound field program PRO LOGIC or 3 STEREO is selected.
- Once the output level is adjusted, the level value will be the same in the PRO LOGIC and 3 STEREO programs.
- If the center channel mode is in the “PHANTOM” position, the sound output level of the center speaker cannot be adjusted. This is because in this mode, the center sound is automatically output from the left and right front speakers.

Adjusting REAR LEVEL

If desired, you can adjust the sound output level of the rear speakers even if the output level is already set in “**Speaker balance adjustment**” on pages 16 to 17.

Control range : +10 to –20

- 1 Press the CENTER/REAR/DELAY selector button once or more so that “REAR” appears on the display.
- 2 By continuously pressing the LEVEL control + or – button, the level value changes continuously.

Notes

- This adjustment can be made when a sound field program except 3 STEREO is selected.
- Adjustment can be made to PRO LOGIC, HALL, ARENA, DISCO, STADIUM and MONO MOVIE individually.

USING SOUND FIELD PROCESSOR

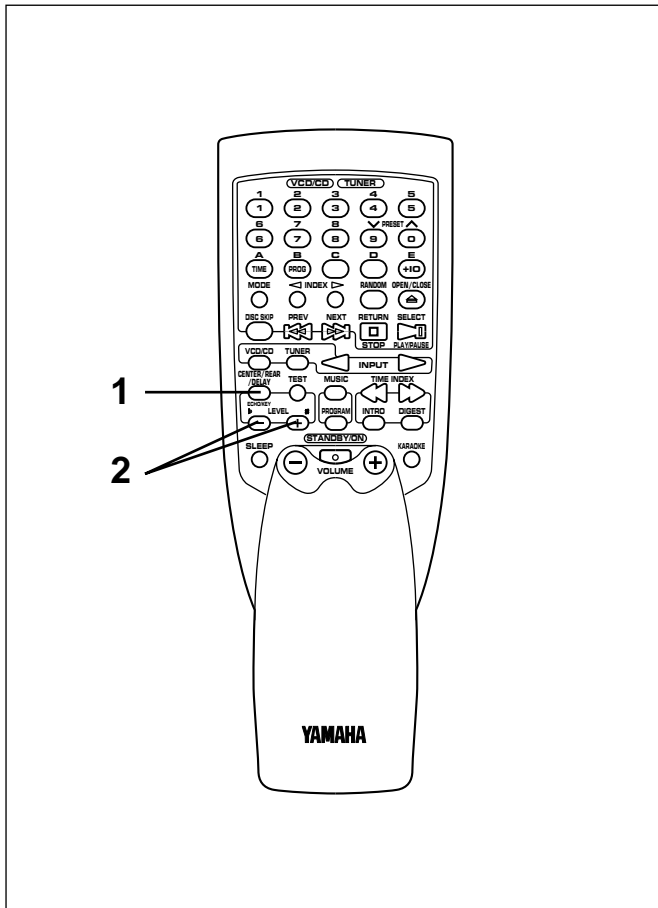

Adjusting DELAY TIME

You can adjust the time difference between the beginning of the sound from the front speakers and the beginning of the effect sound from the rear speakers.

The larger the value, the later the effect sound is generated. This adjustment can be made to all programs (except 3 STEREO) individually.

Control range

PRO LOGIC : 15, 20, 25, 30 milliseconds

HALL, ARENA, DISCO, STADIUM,

MONO MOVIE : 15, 20, 25, 30, 40, 50 milliseconds

- 1 Press the CENTER/REAR/DELAY selector button once or more so that "DEL" appears on the display.

DEL 20ms

- 2 By continuously pressing the LEVEL control + or - button, the value changes continuously.

DEL 25ms

Adjustable

Notes

- When 3 STEREO is selected, this adjustment cannot be made.
- Adding too much delay will cause an unnatural effect with some sources.
- When the LEVEL control button is pressed, sound may be momentarily interrupted.

Note

The values of the delay time, center level and rear level you set the last time will remain memorized even when this unit is in the standby mode.

However, if the power cord is kept disconnected for more than one week, these values will be automatically changed back to the original factory settings.

KARAOKE OPERATION

Singing karaoke

This unit allows you to enjoy singing karaoke by using not only a source for karaoke use but also any normal audio source.

- 1 Connect one or two microphones to the MIC jack(s) on the front panel.
- 2 Select a karaoke mode (L R, L, R or VOCAL CUT) by pressing the KARAOKE button once or more so that the corresponding name appears on the karaoke mode indicator.

* Whenever you press the KARAOKE button, the karaoke mode changes and is displayed as follows.

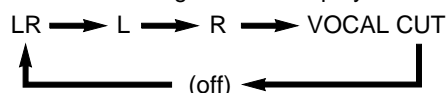

For descriptions of the karaoke modes, see the list below.

- 3 Play back a source. (For source playback, refer to page 18–33.)
- 4 If desired, adjust the level of echo effect and key level of the source currently played back. (For details, see the next page.)
- 5 While singing, adjust the mixing level of singing voice by turning the MIC MIXING level control.
- 6 If desired, adjust the tonal quality of singing voice by turning the MIC TONE control.
* Turning the MIC TONE control clockwise makes tonal quality softer.

To cancel the karaoke mode

Press the KARAOKE button once or more until the karaoke mode indicator goes off, or press the PROGRAM button to select a sound field program.

Note

The microphone(s) connected to the MIC jack(s) on the front panel of this unit is available only when a karaoke mode is selected.

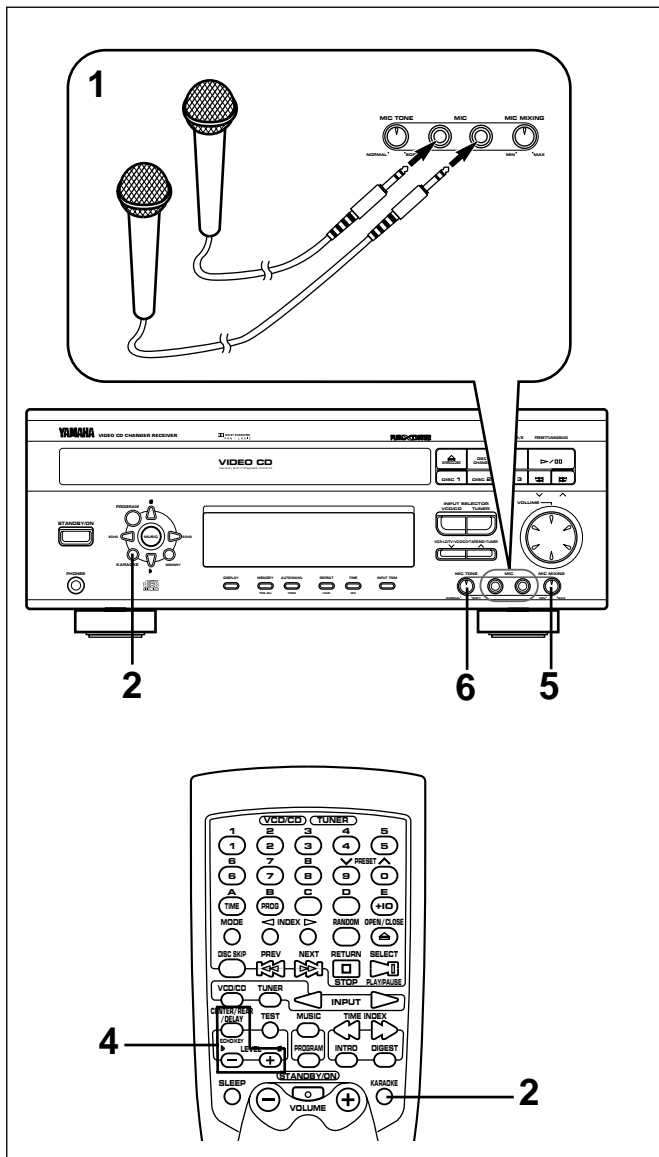

Karaoke modes (KARAOKE)

	Mode	Feature
For a karaoke source (without vocals)	L R (STEREO)	Signals on the left channel and the right channel are output from the left and right speakers respectively. Selecting this mode is suitable for singing karaoke by using a source which contains background music and no vocal.
For a multisound source	L (L ONLY)	Only signals on the left channel of the source are output from the left and right speakers. When using a karaoke source which contains both background music and original vocals on the right channel and background music only on the left channel, selecting this mode is suitable for singing karaoke.
	R (R ONLY)	Only signals on the right channel of the source are output from the left and right speakers. When using a karaoke source which contains both background music and original vocals on the left channel and background music only on the right channel, selecting this mode is suitable for singing karaoke.
For a normal source	VOCAL CUT	Medium frequencies of the source sound (vocals etc.) are attenuated. Select this mode when you sing karaoke using a normal audio source with vocals. Note There may be a case that vocals cannot be attenuated effectively depending on a source.

Note
When using a multisound source for Karaoke use, be sure to select the L or R mode. If the VOCAL CUT mode is selected, depending on a source, sound may become unnatural.

KARAOKE OPERATION

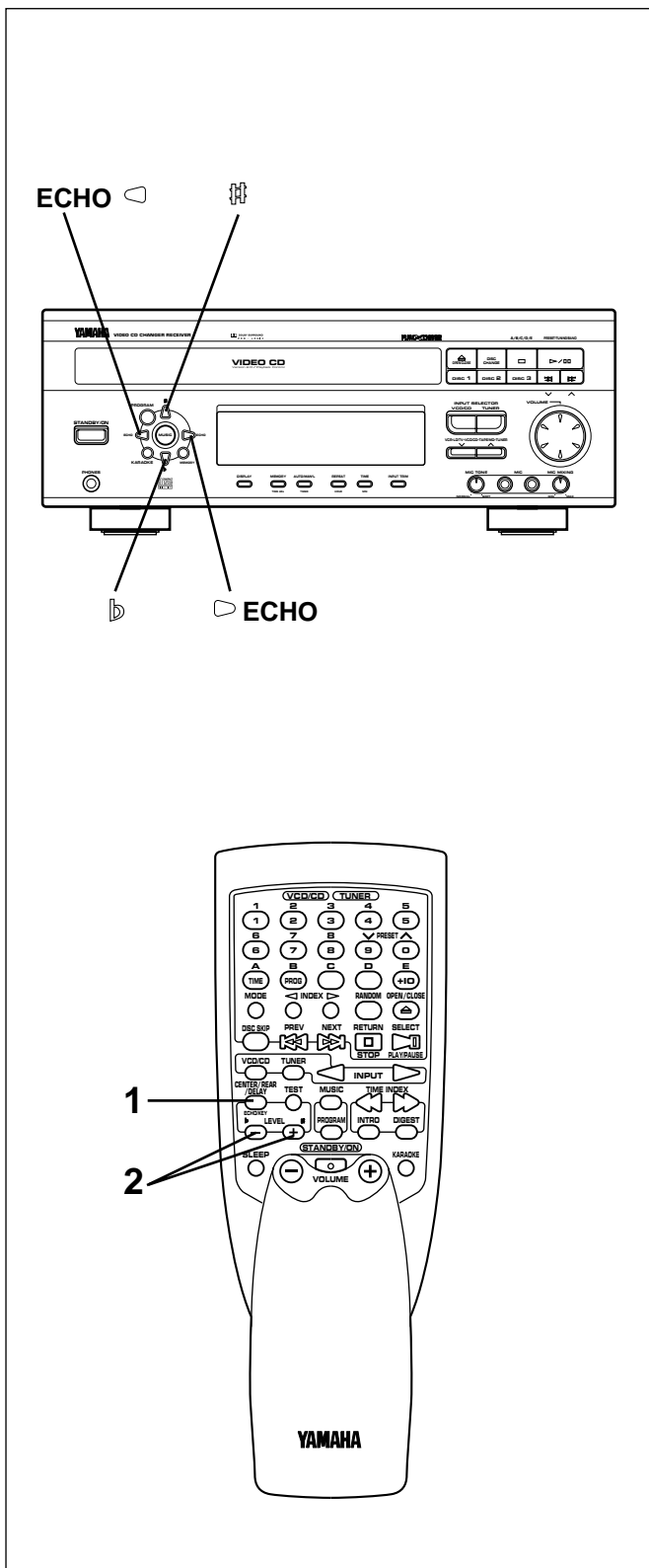



Adjusting the level of echo effect

You can adjust the level of echo effect applied to the sound input from the microphone(s).

Control range: OFF (off), MIN (minimum), MID (middle), MAX (maximum)

On the front panel:

Press the ECHO  button once or more to increase the level.

Press the ECHO  button once or more to decrease the level.

On the remote control transmitter:

1 Press the ECHO/KEY selector button once or more so that "ECHO" appears on the display.

2 Press the LEVEL + button to increase the level.
Press the LEVEL - button to decrease the level.

Note

This adjustment can be made only when a Karaoke mode (L R, L, R or VOCAL CUT) is selected.

Adjusting key level of the source currently played back

The key level adjustment can be made only when the Video CD player is selected as the source.

Control range: -6 to 6

On the front panel:

Press the  button once or more to decrease the level.

Press the  button once or more to increase the level.

On the remote control transmitter:

1 Press the ECHO/KEY selector button once or more so that "KEY" appears on the display.

2 Press the LEVEL + button to increase the level.
Press the LEVEL - button to decrease the level.

Notes

- This adjustment can be made only when the L R, L or R mode is selected.
- You can change the key level even while playing back a still picture (on a Video CD) though it is not effective until the playback of still picture end.

To reset the key level to ± 0

- Turn this unit into the standby mode.
- Change to another input source by using the INPUT SELECTOR buttons.
- Turn the built-in equalizer to "flat". (See page 35 for details.)
- Change the currently selected karaoke mode to another.

KARAOKE OPERATION

Recording your vocal mixed with the source onto a tape (adding effects of the selected karaoke mode and other karaoke functions)

Only when a karaoke mode is selected and one or two microphone(s) are connected to this unit, you can record your vocal input from the microphone(s) along with the source onto a tape (or MD) by using the tape deck, VCR, etc. connected to the TAPE/MD OUT and/or VCR OUT terminals on the rear of this unit.

In addition, effects of the selected karaoke mode, and effects of karaoke functions (MIC MIXING level, MIC TONE, ECHO and/or key level control) can also be recorded with the vocal and the source.

To record:

- 1 Select the source to be recorded by pressing the corresponding INPUT SELECTOR button.
- 2 Prepare to sing Karaoke by using microphone(s).
- 3 If you want to record effects of karaoke functions (MIC MIXING level, MIC TONE, ECHO and/or key level control) together, make adjustments on them.
- 4 Play the source and then turn up the VOLUME control to confirm the input source.
- 5 Begin recording on the tape deck (or MD recorder etc.) or VCR connected to this unit.
- 6 Begin singing Karaoke.

Notes

- If "VCR" is selected as the input source, recording cannot be made by using the VCR etc. connected to the VCR OUT terminals on the rear of this unit.
- If "TAPE/MD" is selected as the input source, recording cannot be made by using the tape deck etc. connected to the TAPE/MD OUT terminals on the rear of this unit.
- With this recording method, the effect of the built-in graphic equalizer cannot be recorded with the source even if it is used.

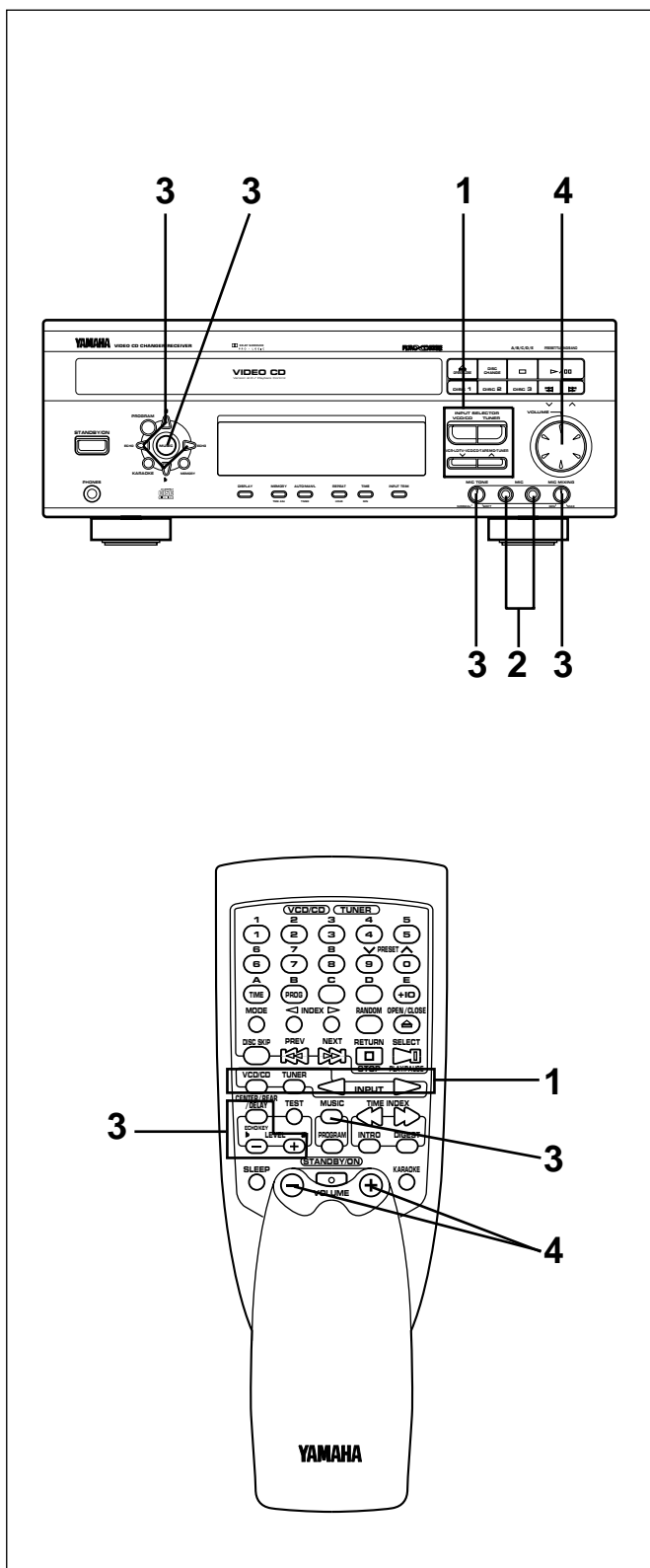

HOW TO USE THE BUILT-IN TIMER

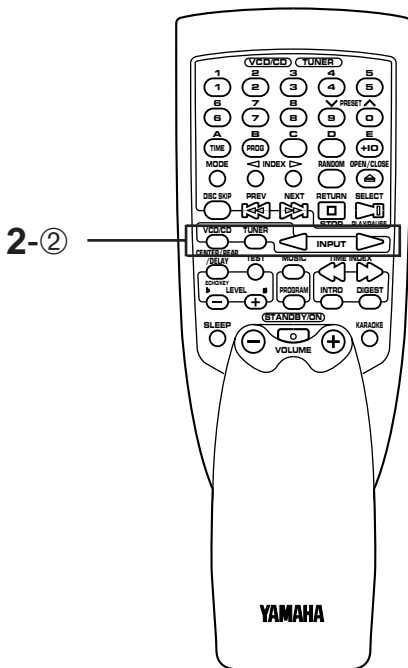
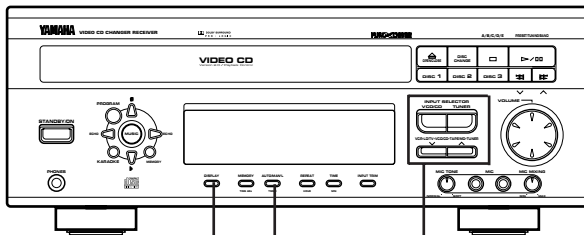

Timer play

By using the built-in timer, you can set the time when the unit turns on and a source begins playing automatically, and the time when the unit turns into the standby mode automatically.

- 1 Prepare the source to be played.

For tuner:

Tune in to the station you will listen to.

For Video CD player:

Load a disc on the disc table. If more than one disc are loaded on the disc table, select the disc by using the DISC selector buttons or the DISC SKIP button.

- 2 Press the DISPLAY button. Whenever the DISPLAY button is pressed, the display mode changes as follows. On each mode, make a setting for the timer play, following the setting procedure described below.

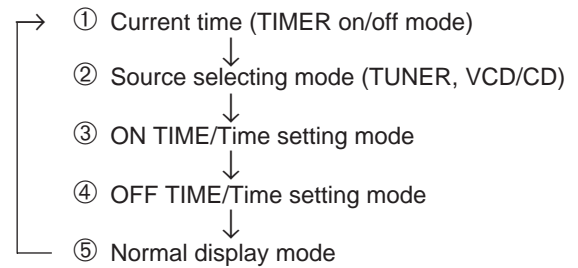

Note

The display mode will be changed to the next mode after about 8 seconds elapse in turn automatically. If the mode is changed before the setting is completed, call the mode again by pressing the DISPLAY button once or more.

Setting procedure:

- ① **Current time**
Check to be sure that the current time is correct, and press the TIMER button so that "TIMER" lights up on the display.
- ② **Source selecting mode**
Select the source (TUNER or VCD/CD) to be played with the INPUT SELECTOR buttons.
* If "TUNER" is selected, soon it is changed to the frequency display mode. In this mode, you can select the station to listen to by the timer play by using the PRESET/TUNING/BAND selector button, A/B/C/D/E button and ^ / ∨ buttons.

HOW TO USE THE BUILT-IN TIMER

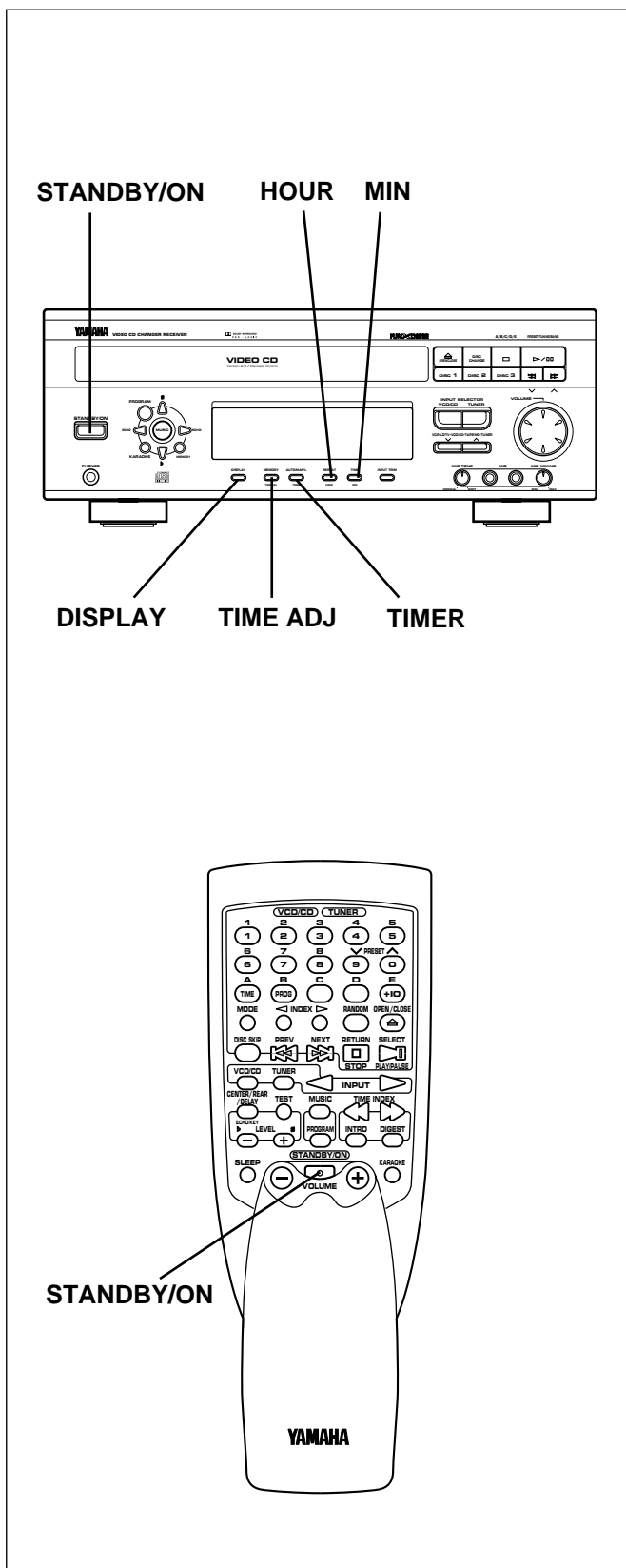

③ ON TIME/time setting mode

["ON TIME" appears on the display, and soon it is changed to a time setting mode.]

Set to the time when you want to begin the timer play by using the HOUR button and the MIN button.

④ OFF TIME/time setting mode

["OFF TIME" appears on the display, and soon it is changed to a time setting mode.]

If necessary, set to the time when you want to finish the timer play (to turn this unit into the standby mode) by using the HOUR button and the MIN button. Even if you do not set the time, it has already been set so that the timer play finishes after 1 hour.

Note

The TIMER button functions also in the time (ON TIME or OFF TIME) setting mode. (However, it also turns this unit into the standby mode.)

- 3 Press the TIMER button to complete the timer play setting. (This unit turns into the standby mode.) If you will still use this unit, press the STANDBY/ON switch to turn on this unit.

Note

If you continue using this unit after a timer play setting is made, the source set for the timer play will begin playing when the time comes in place of the source played at that time.

To cancel the timer play setting

After the timer play is finished (while the current time is displayed), press the TIMER button so that "TIMER" goes out from the display.

If you do not cancel the timer play setting, this unit will turn on at the same time every day, so it can be used as an alarm.

- * Unless the AC supply lead is unplugged or there is a power failure for more than 5 minutes, the time set on the timer will be retained until it is reset.

How to make time setting in the ON TIME or OFF TIME mode

For the hour:

Press the HOUR button to change the hour to a higher value. Press and hold to change continuously.

For the minute:

Use the MIN button and operate it in the same way as you do to change the hour.

Note

You can also change the hour (or the minute) to a lower value by pressing the HOUR button (or the MIN button) with the TIME ADJ button pressed and held.

HOW TO USE THE BUILT-IN TIMER

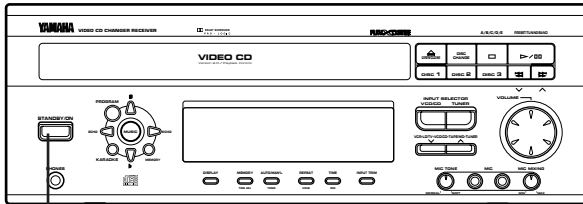

STANDBY/ON

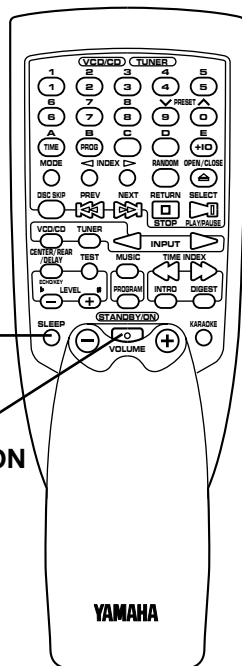

SLEEP

STANDBY/ON

Sleep timer operation

This unit can be turned into the standby mode automatically.

- 1 Play the desired sound source.
- 2 Press the SLEEP button. "SLEEP" appears on the display, and soon it is replaced by "2h00m".
- 3 Press the SLEEP button repeatedly until the desired sleep time appears on the display. The display will change as described below. [Time is displayed by the hour (h) and the minute (m).]

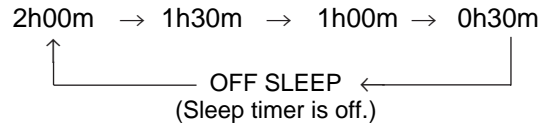

- * The original display mode will resume about 4 seconds after the selection is made.
- * The SLEEP indicator will light up to indicate that the sleep timer is on.

- 4 The unit will turn into the standby mode automatically when the selected sleep time passes.

To confirm the sleep time setting

Press the SLEEP button once. "SLEEP" appears on the display, and soon it is replaced by the remaining time of the selected sleep time.

To change the sleep time

While the SLEEP indicator is illuminated, press the SLEEP button repeatedly until the desired time appears.

To stop the sleep timer operation

Press the STANDBY/ON switch, or press the SLEEP button repeatedly until "OFF SLEEP" appears on the display. (The SLEEP indicator will go out.)

Using the timer and the sleep timer at the same time

You can make a timer play setting so that the timer operates after this unit turns into the standby mode by the operation of the sleep timer.

- 1 Prepare timer play. (See pages 44 to 45)
 - * After the timer play setting is made, press the STANDBY/ON switch to turn on this unit.

- 2 Press the SLEEP button and set the sleep time.

When the sleep timer operation finishes, the timer begins functioning to turn the source on at the preset time.

Note

You cannot use the timer and the sleep timer at the same time in any way other than described here.

TROUBLESHOOTING

If your unit fails to operate normally, check the following points to determine whether the fault can be corrected by the simple measures suggested. If it cannot, or if the fault is not listed in the SYMPTOM column, disconnect the power cord and contact your authorized YAMAHA dealer or service center for help.

	SYMPTOM	CAUSE	REMEDY
GENERAL	The unit fails to turn on when the STANDBY/ON switch is pressed, or turns into the standby mode suddenly soon after the power is turned on.	AC supply lead is not plugged in.	Plug in the AC supply lead.
	It happens that this unit does not work normally.	There is an influence of strong external noise (lightning, excessive static electricity, etc.) or a misoperation on this unit while using this unit.	Turn this unit into the standby mode and disconnect the AC power cord from the AC outlet. After about 30 seconds pass, connect the power and operate this unit again.
	The sound suddenly goes off.	The protection circuit has been activated because of short circuit etc.	Turn this unit into the standby mode, and then turn on to reset the protection circuit.
		The SLEEP timer has functioned.	Cancel the SLEEP timer function.
	No sound from one speaker	Loose speaker connections.	Connect properly.
	No sound from speakers.	Speaker connections are not secure.	Secure the connections.
	No sound from the rear speakers.	One rear speaker connection is loose or bad.	Connect it properly.
		The sound output level to the rear speakers is set to minimum.	Raise the sound output level to the rear speakers.
		No sound field program is selected.	Select the appropriate program.
	No sound from the center speaker.	The sound output level to the center speaker is set to minimum.	Raise the sound output level to the center speaker.
		The center channel mode is in PHANTOM mode.	Select NORMAL mode.
		Incorrect sound field program selection. No sound field program is selected.	Select the appropriate program.
	No sound (or no picture) from an external unit connected with this unit.	Incorrect cord connections.	Connect the cords properly. If the problem persists, the cords may be defective.
		Input source selection is not proper.	Make a proper input source selection.
	Can't set timer.	Current time is not set.	Set current time.
This unit will not operate properly.	The internal microcomputer has been frozen by an external electric shock (lightning, excessive static electricity, etc.) or power supply with low voltage.	Unplug the AC supply lead from the wall AC outlet, and then plug in again after about one minute.	
The volume level cannot be increased, or sound is distorted.	The component connected to the TAPE/MD OUT or VCR OUT terminals of this unit is turned off.	Turn the power to the component on.	
The sound is degraded when listening with the headphones connected to the tape deck etc. that are connected with this unit.	This unit is in the standby mode.	Turn on the power to this unit.	
TUNER	Excessive static in FM broadcasts.	Interference from starting motor of nearby car.	Position the FM antenna as high and as far away from nearby roads as possible. Connect using a coaxial cable.
		Interference from thermostat of nearby electrical appliance.	
	Noise increases during stereo broadcasts.	Antenna input is too weak due to obstructions or excessive distance from broadcasting station.	Check antenna connections.
			Install a multi-element type FM antenna if possible.
	Stereo broadcasts are noisy and STEREO indicator blinks on and off.	Insufficient antenna input.	Install an antenna appropriate for the electric field strength of your area.
	Cannot select preset stations.	Preset memory has been erased.	Reprogram memory presets.
	Buzzing or static during AM broadcasts.	Interference from source such as lightning, fluorescent lights, electric motors or thermostat of nearby electrical appliance.	Problem is difficult to eliminate but can be lessened by grounding AM loop antenna.
TV or microprocessor is being used nearby.		Move away from TV or microprocessor.	
AM broadcast sensitivity is poor.	Radio signal is weak or antenna is not properly connected.	Properly connect AM loop antenna.	
		Change orientation of AM loop antenna.	
		Install an external AM antenna.	

TROUBLESHOOTING

	SYMPTOM	CAUSE	REMEDY
VIDEO CD PLAYER	A disc cannot be played back normally, or there is a noise during playback.	A nonstandardized disc is played back.	Play back another disc.
	Playback will not begin even if disc is loaded.	Disc is upside down.	Load disc label side up.
		Disc is dirty.	Clean disc.
	No sound (or no picture).	The input source selection is incorrect.	Select the Video CD player by pressing the VCD/CD INPUT SELECTOR button.
	Sound stops suddenly (always at the same spot).	Disc is dirty.	Clean disc.
Volume is set too high.		Lower volume.	
A picture is disturbed or unstable.	Setting of the TV MODE switch on the rear panel is improper.	Set the TV MODE switch to another proper position.	
REMOTE CONTROL	Remote control transmitter doesn't work.	Batteries are dead.	Replace batteries.
		Remote control transmitter is too far away or is being used at incorrect angle.	Use within 6 m and 60° radius.
		Direct sunlight or lighting (of an inverter type of fluorescent lamp etc.) is striking the remote control sensor of the main unit.	Change position of the main unit.
	TV functions strangely when the remote control transmitter is used.	Remote control transmitter is being used near TV set with a remote control sensor.	Relocate this unit away from the TV or cover TV's remote control sensor.

SPECIFICATIONS

As a part of policy of continuous improvement, YAMAHA reserves the right to make design and specification changes for product improvement without prior notice. The performance specification figures indicated are nominal values of production units.

■ Amplifier section

Minimum RMS Output Power per Channel

Front L, R	
6 ohms, 1 kHz, 0.9% THD	80W+80W
6 ohms, 1 kHz, 10% THD	100W+100W
Center	
6 ohms, 1 kHz, 0.9% THD	25W
6 ohms, 1 kHz, 10% THD	32W
Rear	
8 ohms, 1 kHz, 0.9% THD	20W
8 ohms, 1 kHz, 10% THD	28W

Input Sensitivity/Impedance

TAPE/MD, LD/TV	300 mV/47 k-ohms
VCR	150 mV/47 k-ohms

Headphone Output Impedance..... 80 ohms

Total Harmonic Distortion (1 kHz)

TAPE/MD to SP OUT (40W/6 ohms)..... 0.09%

Signal-to-Noise Ratio (IHF-A Network)

VCR IN.....80 dB

Graphic Equalizer Characteristics

(100 Hz, 1 kHz, 10 kHz)..... ±10 dB

Microphone Input sensitivity/Impedance (ECHO: OFF)

MIC.....0.7 mV/55 k-ohms

■ Video section

Video Signal Level 1 V_{p-p}/75 ohms

Maximum Input Level 1.5 V_{p-p} or more

Signal-to-Noise Ratio 50 dB or more

Monitor Out Frequency Response

.....5 Hz to 10 MHz, -3 dB

■ Tuner section

Tuning Range

FM	87.5 to 108.0 MHz
AM	
[Singapore model]	531 to 1,611 kHz
[China and General models]	530 to 1,710 kHz

Usable Sensitivity

FM (75 ohms, 30 dB S/N Quieting, 1 kHz, 100% mod.)	1.5 μV (14.8 dBf)
AM	480 μV/m

■ Video CD player section

Type 3 disc carousel auto-changer

Signal Readout

..... Non-contact, 3-beam semi-conductor laser pick-up

D/A Converter 1-bit DAC

Filter8-time oversampling digital filter

Wow and FlutterBelow measurable limits

■ General

Power Supply

[Singapore model]	AC 230V, 50 Hz
[China and General models]	AC 110/120/220/240V, 60/50 Hz

Power Consumption120W
(In the standby mode: 9W)

AC Outlet

UNSWITCHED OUTLET100W max.

Dimensions (W x H x D) 435 x 171 x 383 mm
(17-1/8" x 6-3/4" x 15-1/16")

Weight 10.5 kg (22 lbs. 2 oz.)

AccessoriesAM loop antenna
Indoor FM antenna
Remote control transmitter
Batteries

Specifications are subject to change without notice.



YAMAHA ELECTRONICS CORPORATION, USA 6660 ORANGETHORPE AVE., BUENA PARK, CALIF. 90620, U.S.A.
YAMAHA CANADA MUSIC LTD. 135 MILNER AVE., SCARBOROUGH, ONTARIO M1S 3R1, CANADA
YAMAHA ELECTRONIK EUROPA G.m.b.H. SIEMENSSTR. 22-34, 25462 RELINGEN BEI HAMBURG, FR. OF GERMANY
YAMAHA ELECTRONIQUE FRANCE S.A. RUE AMBROISE CROIZAT BP70 CROISSY-BEAUBOURG 77312 MARNE-LA-VALLEE CEDEX02, FRANCE
YAMAHA ELECTRONICS (UK) LTD. YAMAHA HOUSE, 200 RICKMANSWORTH ROAD WATFORD, HERTS WD1 7JS, ENGLAND
YAMAHA SCANDINAVIA A.B. J A WETTERGRENS GATA 1, BOX 30053, 400 43 VÄSTRA FRÖLUNDA, SWEDEN
YAMAHA MUSIC AUSTRALIA PTY, LTD. 17-33 MARKET ST., SOUTH MELBOURNE, 3205 VIC., AUSTRALIA

YAMAHA CORPORATION
Printed in Malaysia ❁ V227400