

YAMAHA YST-SW100

Active Servo Processing Super Woofer System

CENTER

OWNER'S MANUAL

Thank you for purchasing the Yamaha YST-SW100 Active Servo Processing Super Woofer System.

CONTENTS

CAUTION: UL1270	1
FEATURES	2
CAUTIONS	2
FRONT PANEL DESCRIPTION	3
CONNECTION TO AMPLIFIER	3
CONNECTION TO TELEVISION	4
ADJUSTING VOLUME BALANCE	5
SPECIFICATIONS	5
FREQUENCY CHARACTERISTICS	5

IMPORTANT!

Record the serial number (located on the rear of the cabinet) in the space provided below:

Model: YST-SW100

Serial No.:

Keep this Owner's Manual in a safe place for future reference.

WARNING

TO PREVENT FIRE OR SHOCK, DO NOT EXPOSE THIS APPLIANCE TO RAIN OR MOISTURE.

CAUTION

TO PREVENT ELECTRIC SHOCK DO NOT USE THIS (POLARIZED) PLUG WITH AN EXTENSION CORD RECEPTACLE OR OTHER OUTLET UNLESS THE BLADES CAN BE FULLY INSERTED TO PREVENT BLADE EXPOSURE.

SAFETY INSTRUCTIONS

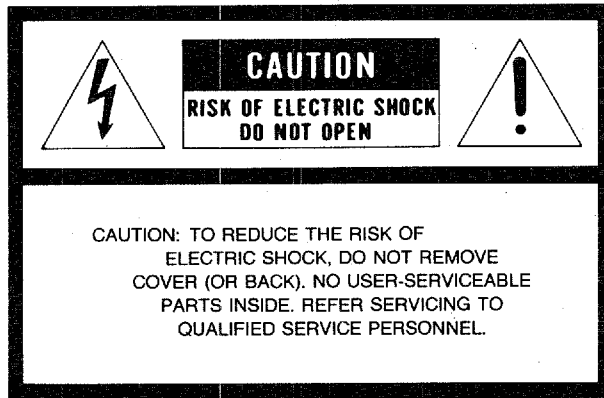

• Explanation of Graphical Symbols



The lightning flash with arrowhead symbol, within an equilateral triangle, is intended to alert you to the presence of uninsulated "dangerous voltage" within the product's enclosure that may be of sufficient magnitude to constitute a risk of electric shock to persons.



The exclamation point within an equilateral triangle is intended to alert you to the presence of important operating and maintenance (servicing) instructions in the literature accompanying the appliance.

WARNING

To reduce the risk of fire or electric shock, do not expose this appliance to rain or moisture.

1 Read Instructions – All the safety and operating instructions should be read before the appliance is operated.

2 Retain Instructions – The safety and operating instructions should be retained for future.

3 Heed Warnings – All warnings on the appliance and in the operating instructions should be adhered to.

4 Follow Instructions – All operating and other instructions should be followed.

5 Water and Moisture – The appliance should not be used near water – for example, near a bathtub, washbowl, kitchen sink, laundry tub, in a wet basement, or near a swimming pool, etc.

6 Carts and Stands – The appliance should be used only with a cart or stand that is recommended by the manufacturer.

6A An appliance and cart combination should be moved with care. Quick stops, excessive force, and uneven surfaces may cause the appliance and cart combination to overturn.



7 Wall or Ceiling Mounting – The appliance should be mounted to a wall or ceiling only as recommended by the manufacturer.

8 Ventilation – The appliance should be situated so that its location or position does not interfere with its proper ventilation. For example, the appliance should not be situated on a bed, sofa, rug, or similar surface, that may block the ventilation openings; or cabinet that may impede the flow of air through the ventilation openings.

9 Heat – The appliance should be situated away from heat sources such as radiators, stoves, or other appliances that produce heat.

10 Power Sources – The appliance should be connected to a power supply only of the type described in the operating instructions or as marked on the appliance.

11 Power-Cord protection – Power-supply cords should be routed so that they are not likely to be walked on or pinched by items placed upon or against them, paying particular attention to cords at plugs, convenience receptacles, and the point where they exit from the appliance.

12 Cleaning – The appliance should be cleaned only as recommended by the manufacturer.

13 Nonuse Periods – The power cord on the appliance should be unplugged from the outlet when left unused for a long period of time.

14 Object and Liquid Entry – Care should be taken so that objects do not fall into and liquids are not spilled into the inside of the appliance.

15 Damage Requiring Service – The appliance should be serviced by qualified service personnel when:

- A.** The power-supply cord or the plug has been damaged; or
- B.** Objects have fallen, or liquid has been spilled into the appliance; or
- C.** The appliance has been exposed to rain; or
- D.** The appliance does not appear to operate normally or exhibits a marked change in performance; or
- E.** The appliance has been dropped, or the cabinet damaged.

16 Servicing – The user should not attempt to service the appliance beyond those means described in the operating instructions, all other servicing should be referred to qualified service personnel.

FEATURES

The YST-SW100 incorporates Yamaha's Active Servo Technology in a totally new super woofer system. The YST-SW100 can be used to dramatically enhance the bass response of both audio systems and television sound output. The YST-SW100 can be easily connected to existing audio systems and televisions, with direct connection to amplifier speaker terminals, or line input through pinjack connectors.

ACTIVE SERVO TECHNOLOGY

The development of Active Servo Technology was based on Yamaha's long years of audio technology research. The YST-SW100 Super Woofer incorporates Active Servo Technology whereby an internal amplifier which virtually eliminates the electrical resistance of the speaker coil is combined with a specially tuned enclosure (Helmholz resonator) which makes use of air inside to the port to strongly reproduce low bass frequencies.

A lot of power is necessary to resonate the air in the port to reproduce low bass sounds. This can be accomplished by strengthening both speaker drive and damping. However, speaker drive and damping are subject to limits due to the electrical resistance of the speaker voice coil. Yet unlike conventional amplifiers, the special amplifier built into the YST-SW100 which works to virtually eliminate electrical resistance of the voice coil. The result is sufficient resonance of the air in the port, enabling powerful, high fidelity low-frequency response.

CAUTIONS

Read these cautions before operating your YST-SW100.

1. Do not open the cabinet as this might result in electrical shock or damage to the unit. Contact your dealer for qualified service should the unit require it.
2. When removing the power plug from a wall outlet, always pull from the plug itself; never yank the cord.
3. Do not attempt to clean the YST-SW100 with chemical solvents as this might damage the finish. Use only a clean, dry cloth.
4. To prevent the enclosure from warping or discoloring, do not place the speaker where it will be exposed to direct sunlight or excessive humidity.
5. Do not place the speaker where it is liable to be knocked over or exposed to falling objects. Stable placement also ensures optimum performance.

6. Since this unit has a built-in power amplifier, heat will radiate from the back panel. Therefore, place the unit at least 10cm (4 inches) away from a wall. Also, do not position with the back panel facing down on the floor or other surface.
7. Placing the speaker on the same stand or shelf as a turntable can result in feedback.
8. This speaker features a magnetically shielded design, but there is still a chance that placing it too close to a TV set might impair picture color. Should this happen, move the TV set away from the speaker.

VOLTAGE SELECTOR (GENERAL MODEL ONLY)

The voltage selector switch on the YST-SW100 rear panel must be set for local voltage BEFORE plugging in the AC mains supply. Voltages are 110/120/220/240V AC, 50/60Hz.

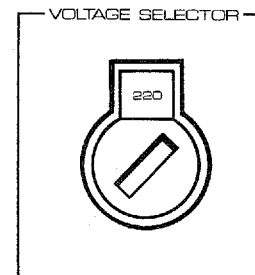

Special Instructions for the U.K. Model

THE WIRES IN THE MAINS LEAD ARE COLOURED IN ACCORDANCE WITH THE FOLLOWING CODE:

Blue: NEUTRAL

Brown: LIVE

As the colours of the wires in the mains lead of this apparatus may not correspond with the colored markings identifying the terminals in your plug, proceed as follows: The wire which is colored BLUE must be connected to the terminal which is marked with the letter N or colored BLACK. The wire which is colored BROWN must be connected to the terminal which is marked with the letter L or colored RED.

FRONT PANEL DESCRIPTION

1 POWER switch / POWER indicator

To turn the unit's power on, press the POWER switch once. A POWER indicator will show that the unit is on. To turn the unit off, press the POWER switch a second time.

2 HIGH-CUT frequency control knob

This control adjusts the high frequency cutoff point, with a range of from 40Hz to 140Hz and above. Use it to achieve the desired response.

3 VOLUME control knob

Operates to increase volume as it is turned from left to right.

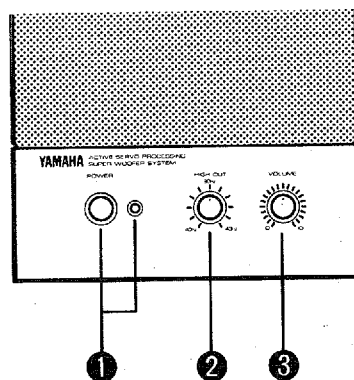

CONNECTION TO AMPLIFIER

There are two ways to connect the speaker to an amplifier; either through the speaker terminals or through the line out terminals.

* Do not attempt to connect the speaker until the amp's power has been turned off.

● CONNECTION TO SPEAKER TERMINALS

The YST-SW100 can be connected to the amplifier's speaker output terminals.

Procedure:

- 1 Disconnect your speakers from the amplifier's speaker output terminals.

- 2 Using the supplied speaker cable, connect the YST-SW100's speaker input terminals (INPUT 1) to the amplifier's speaker output terminals.

- 3 Connect your speakers to the YST-SW100's speaker output terminals (OUTPUT). Be sure that speakers are connected in phase, as crossing polarities (+/-) will result in unnatural sound performance.

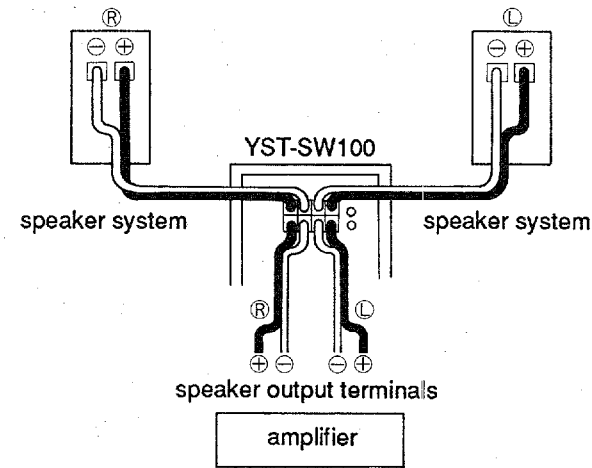

About the Speaker Cable:

The supplied speaker cable has a protective red coating, one side of which is marked with a BLACK line. Connect this side with the BLACK speaker and amp terminals (-), and connect the RED speaker and amp terminals (+) with the unmarked side of the cable.

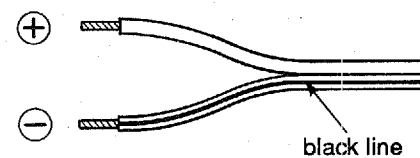

* In some amplifiers, terminals may be colored differently than described above, or may not be colored at all. In these cases, note the (+,-) markings of the terminals to ensure proper phase connections.

Connection to the YST-SW100 input/output terminals:

- ① Twist the end of each cable being used to remove the insulation. This should leave a short section of bare wire at the end.
- ② There are levers either above or below each terminal, as shown. Press on the lever to open a terminal.
- ③ Insert the bare wire end well into the terminal.
- ④ Remove your finger from the lever and allow it to lock snugly on the cable's wire end.
- ⑤ Test the security of the connection by tugging lightly on the cable at the terminal.

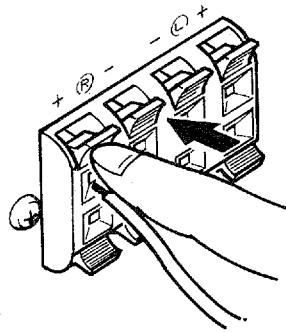

* A cable has been included for connections between the YST-SW100 and your amplifier; other system connections should be made using cable available separately.

● **CONNECTION TO LINE OUTPUT TERMINALS**

Connection can be made to amplifier Line Out terminals. Line output terminals may be labeled either REC OUT or PRE OUT.

* For PRE OUT terminal connection, the amplifier must possess at least two sets of PRE OUT terminals. With some amplifiers with only one PRE OUT terminal, connection can result in no sound from the main left and right speakers. In this case, connect to the speaker terminals as explained in the previous section.

Procedure:

- ① Connect the YST-SW100 line input terminal (INPUT 2) to the amp's REC OUT or PRE OUT terminal using a pinjack cable. (Not supplied). Be sure to make connections in phase, connecting L and R correctly.
- ② Connect left and right speakers to the amp's speaker output terminals as they are usually connected.

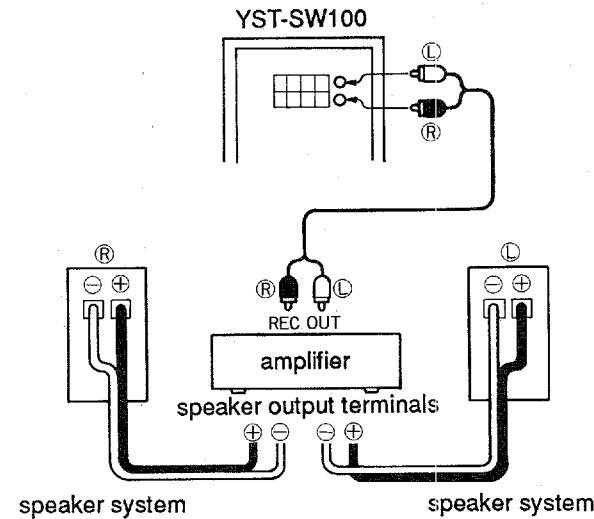

* When connecting to the REC OUT terminals, if the amp has a REC OUT selector, be sure to switch it for the correct source. For information on its operation, consult the amplifier's owner's manual.

* When connected through LINE OUT terminals, any speakers connected to the YST-W100 OUTPUT terminals on the back panel will not produce sound.

* Connection can also be made to a mono amplifier. In this case, either the left or the right YST-SW100 input terminals (INPUT 2) may be used to make the connection.

CONNECTION TO TELEVISION

Connect your television's line output terminal to the YST-SW100 input terminal (INPUT 2) using a pinjack cable. (Not included.)

* Connection to a television can only be made if the television has a line output terminal.

ADJUSTING VOLUME BALANCE

After connections are completed, adjust the volume balance. The volume control on the YST-SW100 enables the adjustment of sound level balance between its output and that of the main left and right speakers.

- ① Turn the volume control knob ③ all the way to zero.
- ② Turn on the power supply to all the components.
- ③ Turn the YST-SW100's power switch ① on.
- ④ Select the source, and adjust the volume of the source amplifier.
- ⑤ Turn the YST-SW100's volume control knob ③ to the right, a little at a time, adjusting the output volume to achieve the desired level balance with the output of the main left and right speakers.
- ⑥ Adjust the High Cut Frequency Control Knob ② to achieve the desired high frequency cutoff point.

* After making initial adjustments as described above, subsequent adjustments of the whole system can be made using the amplifier's volume control.

SPECIFICATIONS

Speaker Unit	18cm (7") woofer (JA1815) magnetic-shielded type x 2
Amplifier Output	70W/5ohms (THD 0.1%, 100Hz)
High-Cut Filter	40Hz-140Hz, variable
Frequency Response	21Hz-180Hz
Power Supply	
U.S.A and Canada model	AC 120V, 60 Hz
European model	AC 220V, 50 Hz
British and Australian model	AC 240V, 50 Hz
General model	AC 110/120/220/240V, 50/60 Hz
Power Consumption	
U.S.A and Canada model	100W
European model	100W
British and Australian model	100W
General model	100W
Dimensions (WxHxD)	206mm x 570mm x 400mm (8-1/8" x 22-1/2" x 15-3/4")
Weight	16Kg (35.3lbs.)
Accessories	speaker cable (4m) x 2, anti-slip spacers x 4*

* To use the supplied anti-slip spacers, attach them to the YST-SW100's bottom panel.

* Specifications are subject to change without notice due to product improvements.

FREQUENCY CHARACTERISTICS

● HIGH-CUT FILTER

Frequency characteristics of the YST-SW100's High Cut Frequency Control:

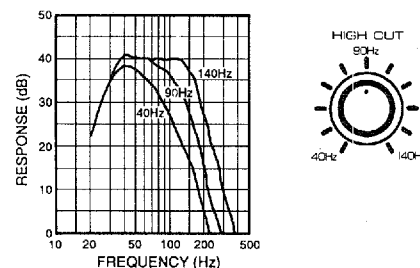

● REFERENCE EXAMPLE

These are frequency response characteristics obtained by combining the YST-SW100 with the YAMAHA NS-10M Monitor Speaker System. During this reference test, the YST-SW100's High Cut Frequency Control was set at 90Hz, obtaining the frequency response characteristics as shown below.

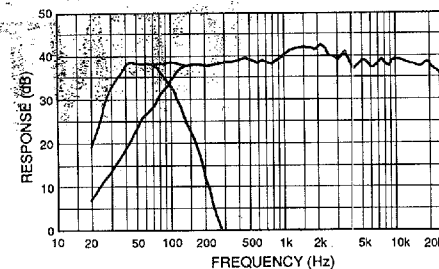

* Results may vary according to room conditions and speaker placement.

YAMAHA

YAMAHA CORPORATION

P.O. Box, Hamamatsu, Japan

VH92210-0 BWgW,g Printed in Japan ©