

# YAMAHA

## YRM-502

### FM VOICING PROGRAM II

#### OWNER'S MANUAL

### PROGRAMME DE REGISTRATION FM II

#### MANUEL D'UTILISATION

### FM VOICING PROGRAM II

#### BEDIENUNGSANLEITUNG

# INTRODUCTION

Congratulations on your purchase of the Yamaha FM Voicing Program II. In order to appreciate the full performance of this program, please read this Owner's Manual carefully and completely. Keep it in a safe place for future reference.

## Features

The Yamaha FM Voicing Program II (YRM-502) is a ROM cartridge which is used with the Yamaha FM Sound Synthesizer unit to create voices. This allows a wide variety of original voices to be created by the FM sound generation system, in addition to the 46 voices already contained in the FM Sound Synthesizer unit. Here is a list of this program's main features.

- This ROM cartridge program allows the user to alter the voices contained in the FM Sound Synthesizer unit, as well as create new voices from scratch.
- The data can be displayed on the screen as it is entered from the Music Computer (or MSX computer equipped with an FM Synthesizer unit) keyboard. Sound can also be output for checking the voice data as it is edited or created.
- Newly created voice data can be saved on cassette tape or Data Memory Cartridges (UDC-01) and later utilized with the FM Music Macro and/or FM Music Composer program cartridges (sold separately).
- The voice data and the table of voices can both be printed out using an optional MSX-compatible printer.
- The music keyboard functions of the FM Music Synthesizer unit can be called up and used for playback when the FM Voicing Program II is in use.
- Newly created voicing data can be saved onto a floppy disk (with SFG-05 or SFK-05 Synthesizer unit only).
- Playback using MIDI keyboard instead of the special music keyboard becomes possible (with SFG-05 Synthesizer unit only).

## How to use this manual

We suggest that you read this manual while actually using the FM Voicing Program II. This way, anything you read can immediately be put into practice, so that your hands become familiar with the various operations.

Chapter I explains how to connect the components of your system.

Chapter II is an introduction to the main features of this program.

Chapter III provides a detailed explanation of the creation of voices and the management of data.

Chapter IV gives some examples of voice creation.

The Appendix contains reference material and explains the theory of FM voice generation.

If you are already familiar with the FM voicing Program (version 1), a simple look at the next page will give you enough information to get started.

## ***A quick introduction to the new operations***

Starting the program	Enter <b>call fmv</b> when the initial messages of the BASIC are displayed.
Selecting the key velocity	Use the <b>F2</b> and <b>F3</b> keys.
Modifying a numerical value	Use the <b>HOME</b> (-1) and <b>DEL</b> (+1) keys. Holding the <b>INS</b> key down while using the <b>HOME</b> and <b>DEL</b> keys produces larger changes.
Operator	Use <b>TAB</b> to copy an operator, and <b>CTRL</b> + <b>TAB</b> to restore it.
Key definition	Three screen pages are provided: one for the keys used in Edit mode, another for the keys used in Command mode, and the last one for the keys used in any mode. Press the <b>F5</b> key from the desired mode, (Edit, Command, or Filer mode).
Saving and loading	The TR command causes a new screen page to be displayed. This page is exclusively used for the management of your files (File mode).
Printing	The SP command allows for the selection of printer (1 = MSX; 2 = EPSON).

## ***Contents***

<b><i>CHAPTER I SETTING UP YOUR SYSTEM</i></b> .....	1
<b>SYSTEM COMPONENTS</b> .....	2
<b>SYSTEM CONNECTIONS</b> .....	3
<b>PRECAUTIONS REGARDING THE USE OF CARTRIDGES</b> .....	4
 <b><i>CHAPTER II GETTING ACQUAINTED WITH THE FM VOICING PROGRAM II</i></b> .....	5
<b>INITIAL DISPLAYS AND PROGRAM OUTLINE</b> .....	6
Starting the program .....	6
Operation outline.....	7
<b>DISPLAYING THE SCREEN PAGES</b> .....	9
<b>KEYBOARD OPERATION</b> .....	12
Keys used in Edit mode.....	12
Keys used in Command mode.....	14
Common use keys .....	15
<b>COMMANDS</b> .....	16
 <b><i>CHAPTER III OPERATING THE FM VOICING PROGRAM II</i></b> .....	17
<b>COMMAND MODE</b> .....	18
DI (DIRECTORY) .....	18
n (SELECT n).....	19

SA n (SAVE n) .....	19
RE n (RESTORE n) .....	19
KI n (KILL n) .....	20
CO n, m (COPY n to m) .....	20
SW n, m (SWAP n, m) .....	20
PR n, m (PRINT n thru m) .....	21
HE (HELP) .....	21
MU (MUSIC KEYBOARD FUNCTION) .....	21
SP a (SELECT PRINTER a) .....	22
TR (TRANSMISSION OF DATA) .....	22
<b>FILE MODE</b> .....	<b>23</b>
Cassette recorder .....	23
Data Memory Cartridge .....	24
Floppy disk drive .....	24
<b>EDIT MODE</b> .....	<b>25</b>
Switching to the Edit mode .....	25
Editing .....	25
Parameters .....	26
Other editing features .....	37
<b>KEYBOARD SPLIT FEATURE</b> .....	<b>38</b>
Keyboard for editing .....	38
Keyboard for comparison .....	38
Setting the keyboard split point .....	39
 <i>CHAPTER IV CREATING VOICES</i> .....	 41
<b>THE BASICS OF VOICE CREATION</b> .....	42
Basics of voice creation using FM Sound generation .....	42
The concept of algorithms .....	45
The concept of voice creation .....	46
<b>SOME EXAMPLES OF VOICE CREATION</b> .....	51
The creation of brass voices .....	51
The creation of string voices .....	52
The creation of organ voices .....	53
 <i>APPENDIX</i> .....	 55
<b>INTRODUCTION TO FM VOICE SYNTHESIS</b> .....	56
Basic knowledge needed to create sound .....	56
FM Sound generation .....	59
Envelop generator .....	62
Key scaling feature .....	64
<b>VOICE DATA PROCESSING</b> .....	66
<b>ERROR MESSAGES</b> .....	67
<b>MIDI IMPLEMENTATION CHART</b> .....	68
<b>ALPHABETIC INDEX</b> .....	69

# **CHAPTER I SETTING UP YOUR SYSTEM**

## SYSTEM COMPONENTS

Here is a list of the components that you need to enjoy the full potential of the FM Voicing Program II.

- **Yamaha Music Computer or MSX computer + FM Sound Synthesizer unit** The main unit of the system. The Music Computer is equipped with a Yamaha Sound Synthesizer Unit (SFG-01 or SFG-05).
- **Color monitor or color TV** Necessary for visual control of the parameters and for audio output (if you do not connect an audio system). Consult Owner's Manual for connection with the Music Computer.
- **Yamaha Music keyboard (YK-01 or YK-10/20)** Used to playback and to compare voices.
- **MIDI keyboard plus two MIDI cables** With SFG-05 only. Can be used instead of the Yamaha Music Keyboard.
- **Cassette recorder** For storing the voice data.
- **Yamaha Data Memory Cartridge (UDC-01) plus Single Cartridge Adaptor (CA-01)** For easy storing of voice data. Adaptor is unnecessary if your computer is equipped with two cartridge slots.
- **Floppy disk drive** With SFG-05 or SFK-05 only. (Consult Owner's Manual for connection.)
- **Yamaha Thermal Printer (PN-101) or MSX-Compatible printer** To print out the voice data and the table of voices.
- **Stereo amplifier/speaker system or keyboard amplifier** To fully enjoy the high quality FM Sound.

# SYSTEM CONNECTIONS

**Caution:** Before connecting the system, be sure that the power to all components is turned OFF.

- (1) Please refer to the Owner's Manual supplied with your Music Computer for connecting video display, printer and cassette recorder.
- (2) Connect the Data Memory Cartridge (UDC-01) or the floppy disk drive set.
  - ★ CX-5M Music Computer: You need a Single Cartridge Adaptor (CA-01). First assemble the adaptor with the cartridge or disk drive connector, then insert the assembly into the computer's rear slot.
- (3) Insert the Music Keyboard cable connector into the MUSIC KEYBOARD 20-pin jack at the left side of the computer.
- (4) If you are using a MIDI Keyboard, you need two MIDI cables.

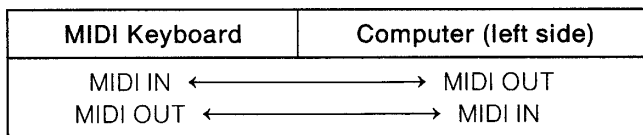

- (5) Connect the audio output L/R (computer's left side) to the AUX-IN jacks of your stereo system. Make sure to connect left and right channel correctly.

Fig. 1 System configuration

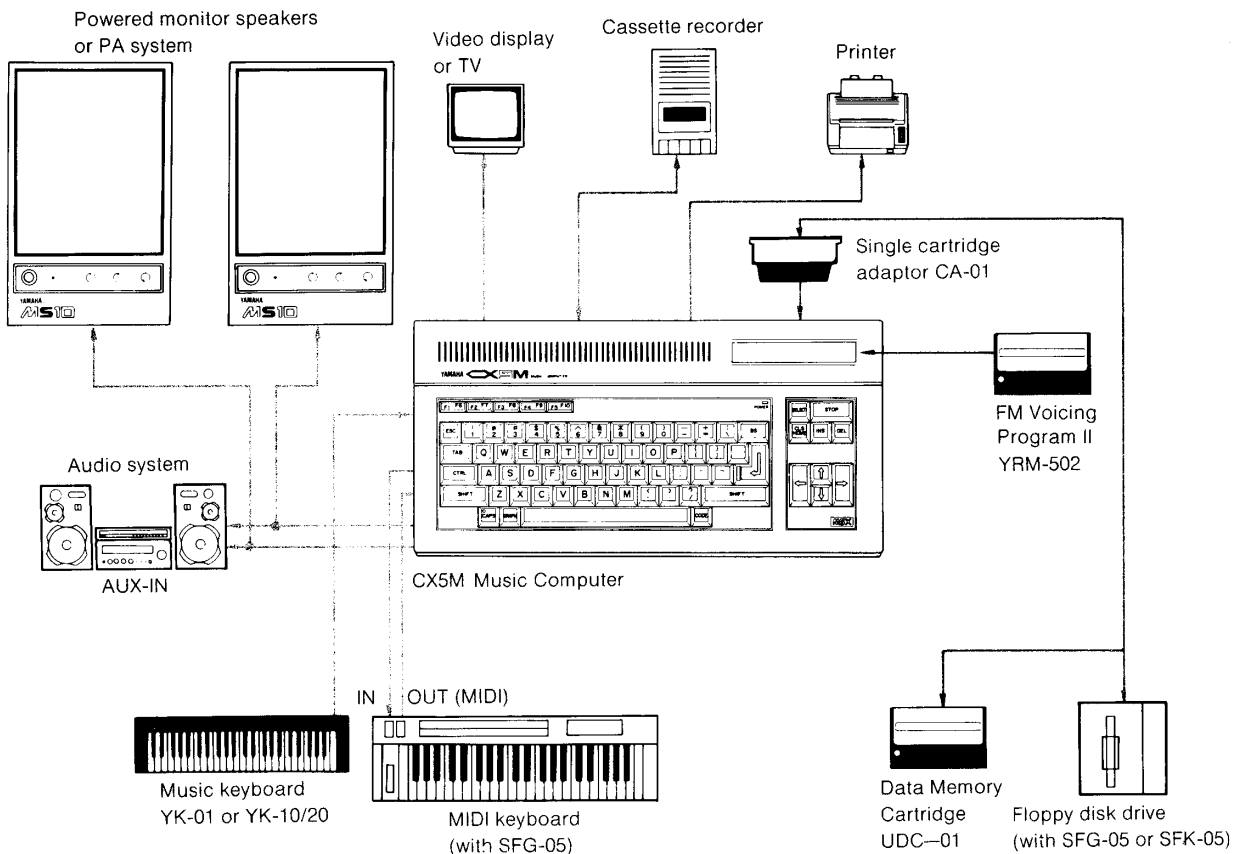

# ***PRECAUTIONS REGARDING THE USE OF CARTRIDGES***

- **Always** turn the power to the computer OFF before inserting or removing a cartridge; removing or inserting a cartridge when the power is ON can easily cause trouble.
- **Always** return the cartridges into their protective package after use and reinstall the rear slot cover when a cartridge is removed from rear slot as dust on the connection pins can produce erratic operation.

*Fig. 2 Insertion of the cartridges*

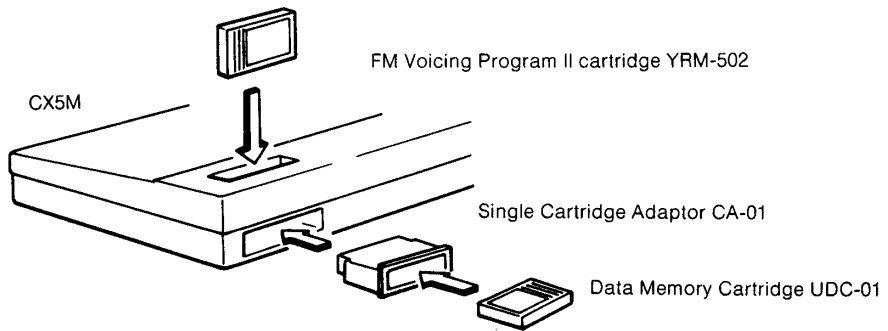

First, insert the cartridge into the adaptor, then insert the assembly into the rear slot.

- Please carefully read the information supplied on the Data Memory Cartridge packing.



**CHAPTER II  
GETTING ACQUAINTED  
WITH THE  
FM VOICING PROGRAM II**

# INITIAL DISPLAYS AND PROGRAM OUTLINE

## Starting the program

- (1) Make sure that all the equipment is properly connected.
  - (2) With the power to the computer OFF, insert the FM Voicing Program II cartridge into the upper cartridge slot of your computer.
  - (3) If you are using a floppy disk drive unit, turn ON the power of the drive unit.
  - (4) Turn ON the power of the computer.
  - (5) If you are using a floppy disk drive unit, the message `Enter date (year-month-day)` appears. Write the date using two digits each for year, month, and day, then press the `RETURN` key. You may omit the date and just press `RETURN`.
  - (6) The initial messages of the BASIC appear (Fig. 3), indicating that the computer is ready to accept BASIC commands.
  - (7) To start the FM voicing Program II, type `call fmv` followed by `RETURN`. `call` may be abbreviated by `_` (underscore), and letters may be entered either as lower or upper case.
  - (8) The program will start automatically. An opening display will appear for a few seconds, then the program will switch to the display shown in Fig. 4.
- ★ If the program does not run, turn OFF the power to the computer and make sure that the FM Voicing Program II cartridge is properly inserted.
  - ★ Always turn the power to the computer OFF before inserting or removing a cartridge; removing or inserting a cartridge when the power is ON can easily cause trouble.

Fig. 3 BASIC initial display

```
MSX BASIC version 1.0
Copyright 1983 by Microsoft
28815 Bytes free
Ok
call fmv
```

Fig. 4 Initial display of the FM Voicing Program II

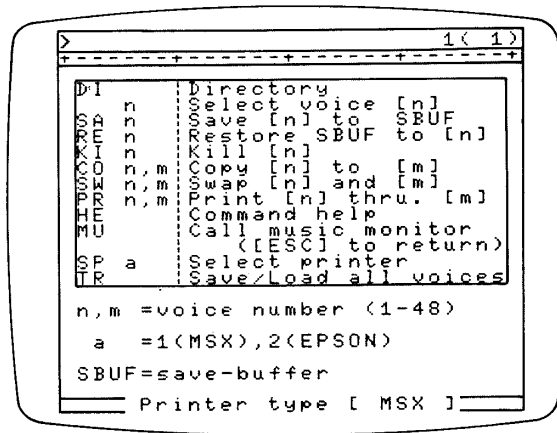

**Operation outline**

• Modes

The FM Voicing Program has a number of functions. These are divided into three operation modes which permit a structured use of the program.

- EDIT mode**                Used for the actual creation of voices.
- COMMAND mode**        Used for the management of data.
- FILE mode**                Used for saving and loading voice data.

• Displays

A total of 8 different screen pages can be displayed.

- Main display**            Used for the actual creation of voices (Edit mode). The Upper part of this page also allows for the input of commands.
- Command menu**        This display provides a short definition of the commands other than those related to loading/saving operations. When the Command menu is displayed, you are in the Command mode.
- Directory**                This shows a list of voice names. When the Directory is displayed, you are in the Command mode.
- Command key list**      Gives a short definition of the keys used in Command mode. This is a “read-only” display.
- Edit key list**            Gives a short definition of the keys used in Edit mode. This is a “read-only” display.
- Common key list**        Gives a short definition of keys used in any mode. “Read-only” display.
- Filer**                    Used for saving/loading operations. This display gives a menu of related commands. When the Filer is displayed, you are in the File mode, and only the commands appearing in the Filer menu are accepted.

**Keyboard function** Used for music performance on the keyboard. When this display appears, your computer is controlled by the program built in the synthesizer unit. Consult the Owner's Manual provided with your Music Computer or your Synthesizer Unit.

- **Computer keyboard**

The computer keys are divided into three classes according to the display/mode in which they are available.

**Edit keys** Available in the Edit mode (main display, cursor in the lower section). These keys are used to modify or handle the parameters of the voice currently edited or to switch to another display.

**Command keys** Available in the Command mode. These keys are used for the management of the data, for selecting various options, and for switching to another display.

**Common keys** Available in Edit/Command mode and when the Filer is displayed.

★ Alphanumeric keys are used anywhere an alphanumeric input is required (voice name, command).

*Table 1 Operation modes vs screen pages*

<b>Screen page</b>	<b>Mode</b>
Main display	Edit/Command mode according to the cursor position (lower/upper portion of the screen)
Command menu	Command mode
Directory	Command mode
Command key list	No mode
Edit key list	No mode
Common key list	No mode
Filer	File mode (Command mode restricted to the saving/loading commands)
Keyboard function	No mode

# DISPLAYING THE SCREEN PAGES

This program makes eight different displays available. The first thing you should master is how to obtain a desired display. We suggest that you freely experiment with how to access each display. The following diagrams will help you do this. Basically, there are two ways for switching to another screen page:

- Special key** Special keys of the computer keyboard are used to switch to a desired screen page. Fig. 5 indicates the keys used for this purpose.
- Command** The four commands `HE`, `DI`, `MU` and `TR` are also used for switching to the corresponding screen page. This method applies when you are in Command mode (the square red cursor is blinking in the upper section of the current display). Table 1 indicates which mode is available in each screen page. Type in the command and press the **RETURN** key to activate it.

Fig. 5 Keys used for switching to another screen page

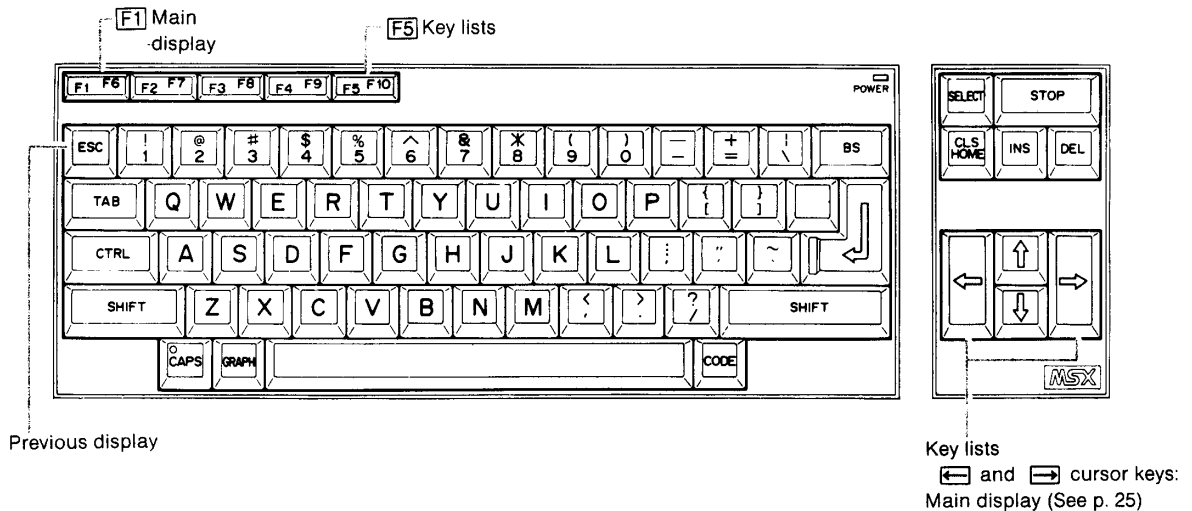
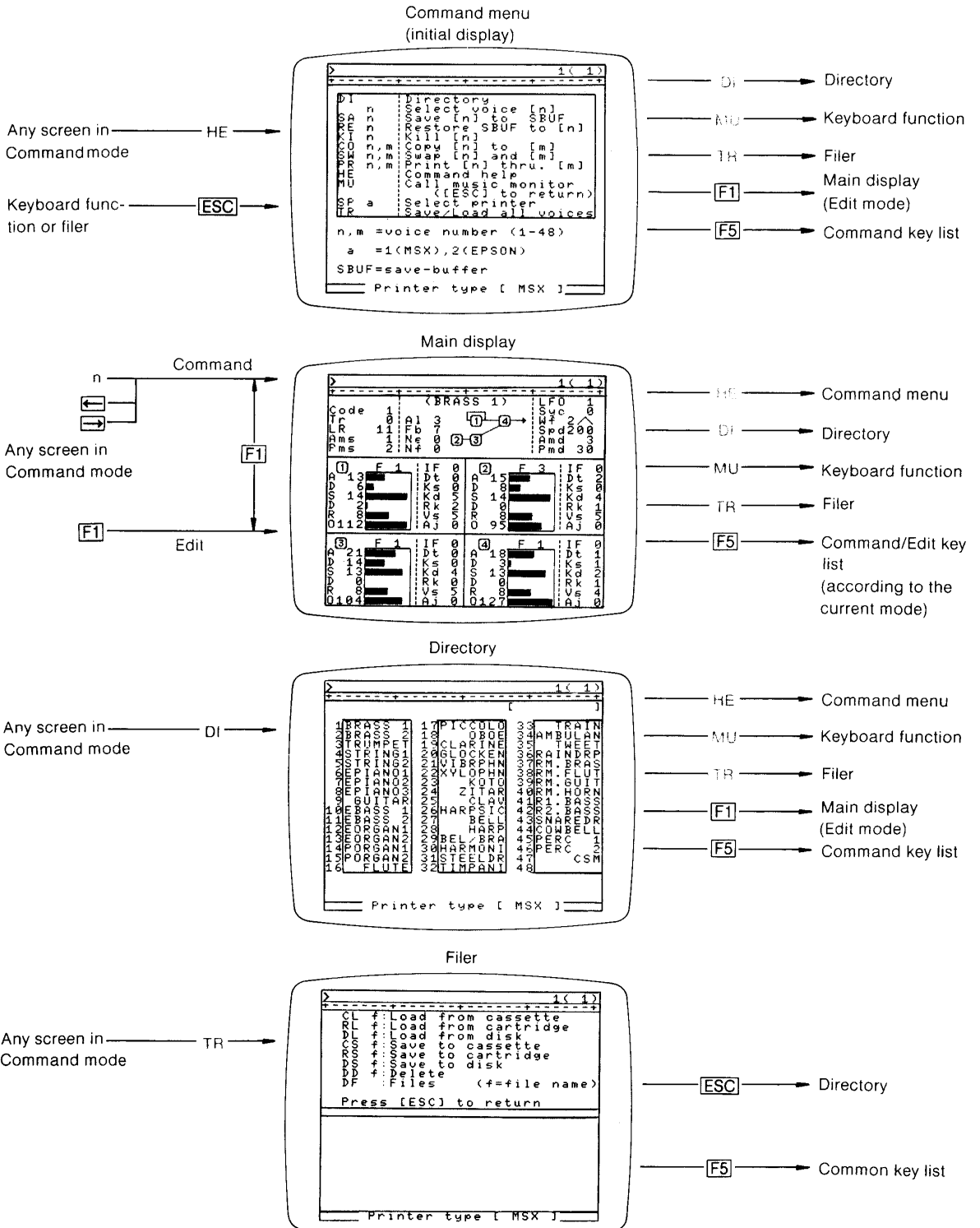

Table 2 Commands used to switch to another display

Command	Display
<code>HE</code>	Directory
<code>DI</code>	Command menu
<code>MU</code>	Keyboard function
<code>TR</code>	Filer
<code>HE</code>	Main display (See p. 25)

Fig. 6 Access to the different displays



### Keyboard function

Any screen in  
Command mode

→ [M] →

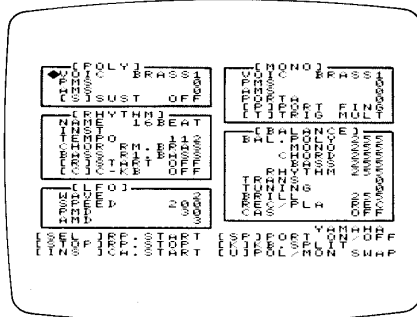

→ [ESC] →

Directory

### Command key list

Any screen in  
Command mode

→ [F5] →

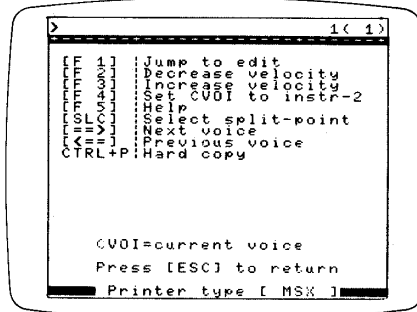

→ [ESC] →

Previous screen

### Edit key list

Main screen in  
Edit mode

→ [F5] →

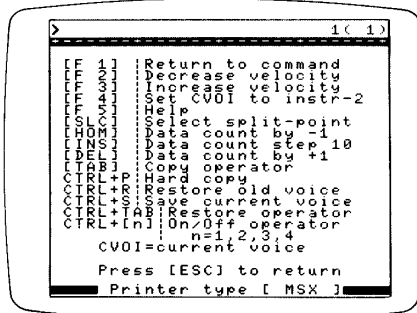

→ [ESC] →

Main screen (Edit mode)

### Common key list

Filer

→ [F5] →

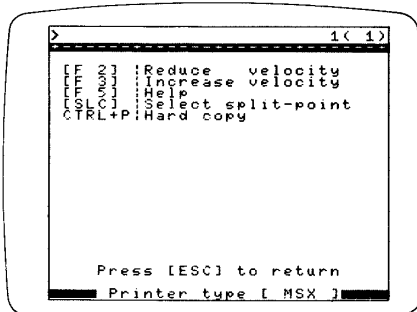

→ [ESC] →

Filer





Fig. 9 Location of the Edit Keys

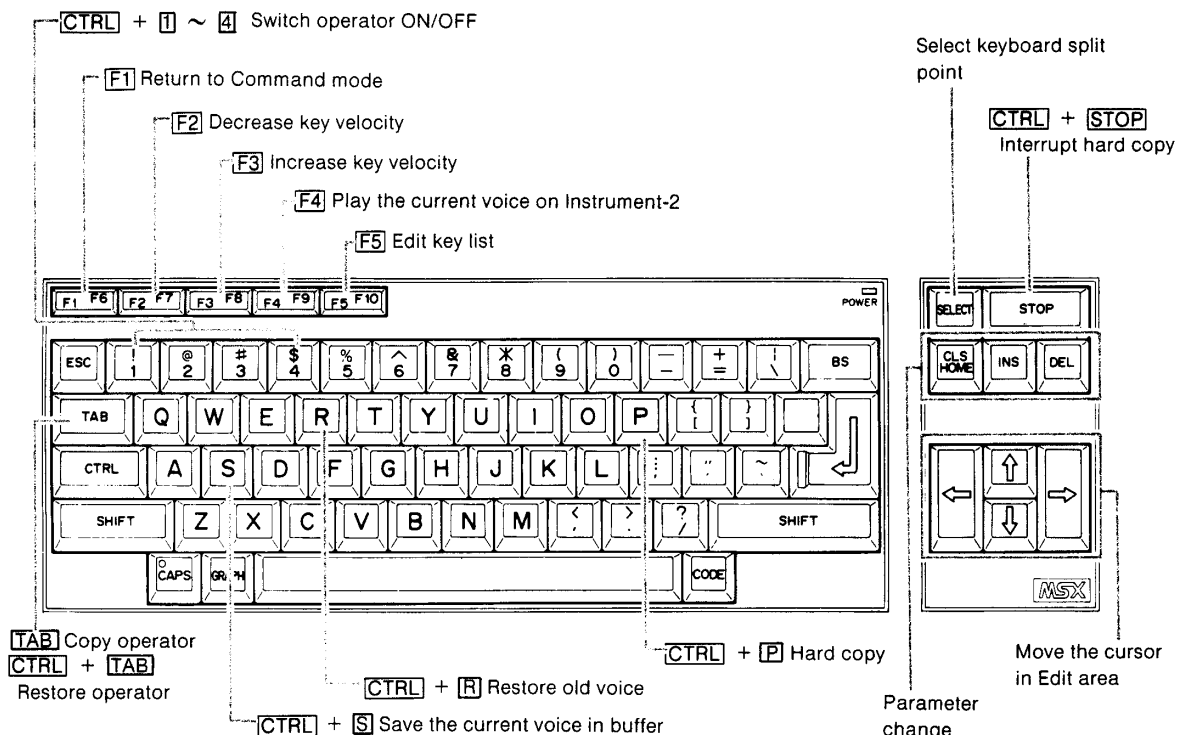

★ To modify a numerical value, move the cursor to the desired parameter by using the **↑**, **↓**, **←** and **→** cursor keys, then use the **HOME**, **INS** and **DEL** keys to alter the value.

Key	Change
<b>HOME</b>	- 1
<b>DEL</b>	+ 1
<b>INS</b> + <b>HOME</b>	- 10 (or minimum value)
<b>INS</b> + <b>DEL</b>	+ 10 (or maximum value)

★ **CTRL** + another key or **INS** + another key means that you must hold down the first key (**CTRL** or **INS**) then press the other key.

★ If you press the **SELECT** key, the system will stall until you press one key on the music keyboard. You may experiment freely. If you get lost, just restart the program by switching the computer OFF, then ON. The original voices contained in the synthesizer unit will be restored.

## Keys used in Command mode

From any screen in Command mode, press the **[F5]** key to display the Command key list.

Fig. 10 The Command key list

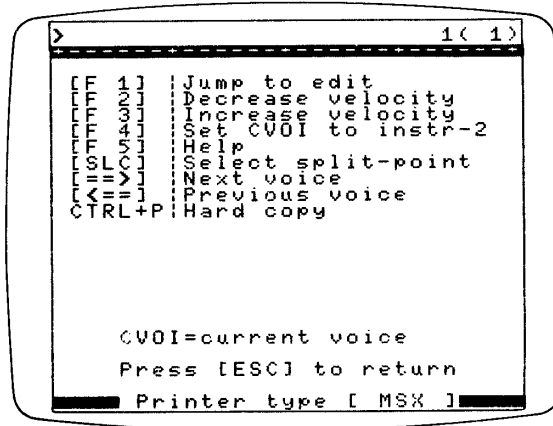
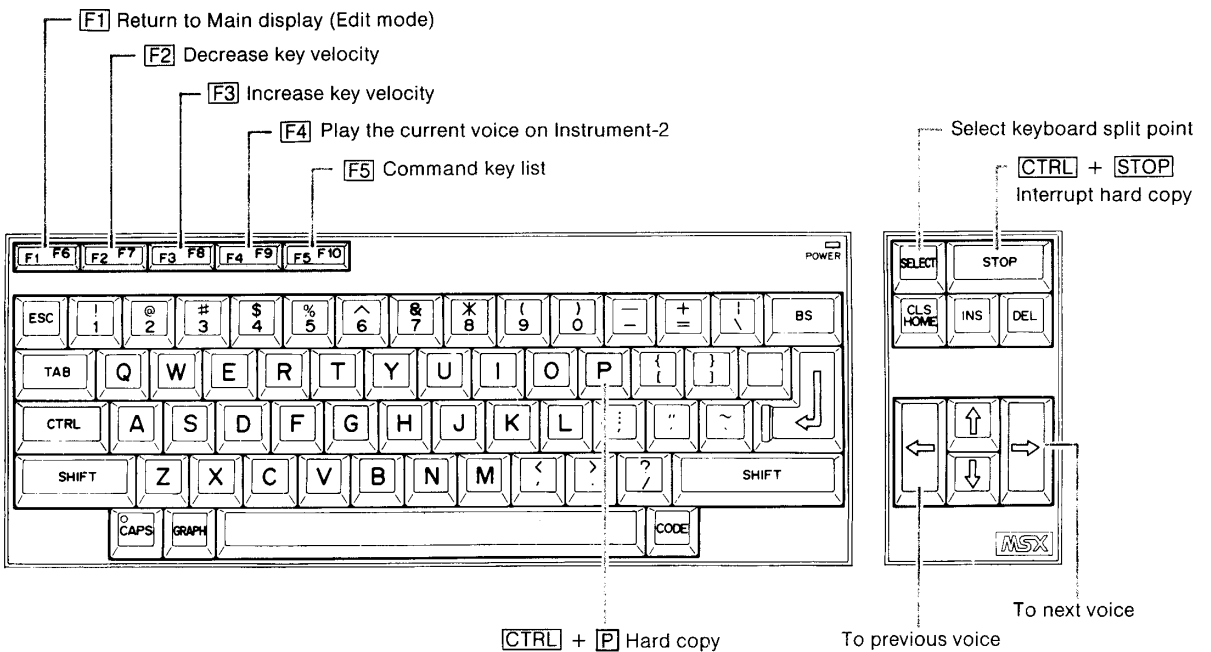

Fig. 11 Location of the Command keys



★ In the Command mode, the **[←]** and **[→]** cursor keys have a very special function: they switch to the Main display like the **[F1]** key does, but the system is still in Command mode. The voice parameters that are now displayed correspond to the next **[→]** or previous **[←]** voice to the voice that was last displayed.



# COMMANDS

The use of some commands have already been explained. A complete list of commands and their definitions are given in the Command menu. Select this display by entering the **00** command from any screen in Command mode.

Fig. 14 The Command menu

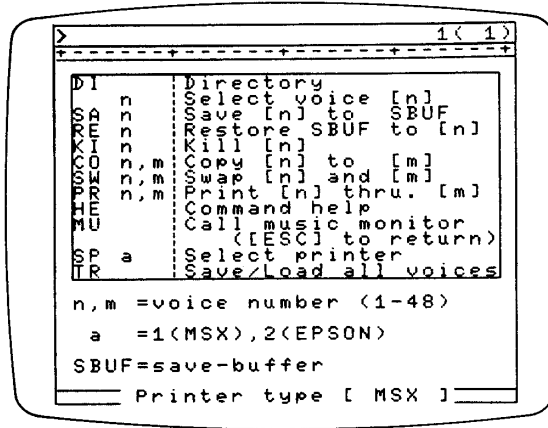

- ★ **00** command: entering a number from 1 to 48 as a command switches to the Main display as the **[F1]** key does, but the system is still in Command mode. The parameters corresponding to the entered voice number are now displayed.
- ★ For commands requiring one or two parameters, first type in the command, one space, the parameter(s) and then press the **[RETURN]** key.
- ★ The filer display has specific commands. Their use is similar to the above commands, but they are accepted in the Filer display only. On the other hand, the Filer does not accept the above commands.

Fig. 15 The Filer command menu

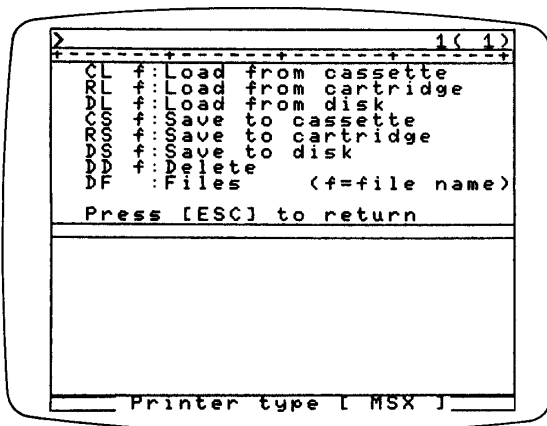

(with SFG-05 or SFK-05  
and disk drive connected)

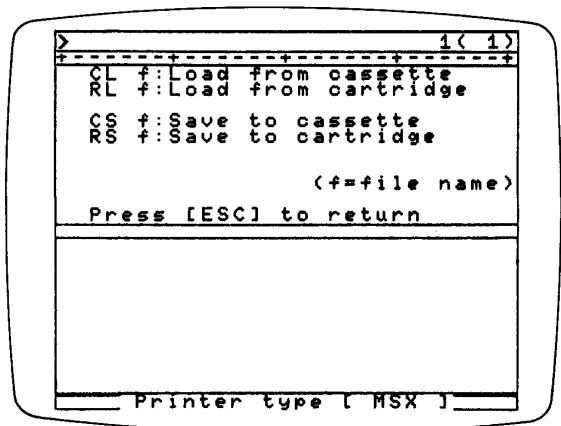

(with other Synthesizer  
unit or when disk drive  
is not connected)

# **CHAPTER III OPERATING THE FM VOICING PROGRAM II**



## ***n* (SELECT *n*)**

This command switches to the Main display, but you are still in the Command mode. The voice parameters corresponding to the number that you entered as a command are now displayed in the screen. If the number *n* is not in the range 1 ~ 48, the message Bad argument appears.

- ★ When you are in Command mode, pressing the (←) or (→) cursor keys produces a similar effect but the number of the voice corresponds to the number of the voice last displayed, decremented (←) or incremented (→) by one.

## ***SA n* (SAVE *n*)**

This is used to store a voice in a temporary memory (save buffer), so that you may further modify the voice and recall it if you are not satisfied with the last modifications.

- ★ The save buffer can accept only one voice data, so that previously stored data will be replaced by the new one when you use this command. See APPENDIX for details on memory organization.
- ★ If *n* is omitted, the data of the voice currently edited is stored in the save buffer.

## ***RE n* (RECALL *n*)**

This command recalls the voice saved in the save buffer. The number *n* designates the destination in the voice memory and may differ from the number *n* you used when storing the voice data to be recalled.

- ★ If you omit to input the number *n*, the voice data stored in the save buffer replaces the data of the voice currently edited.

Fig. 17 SAve and REstore commands

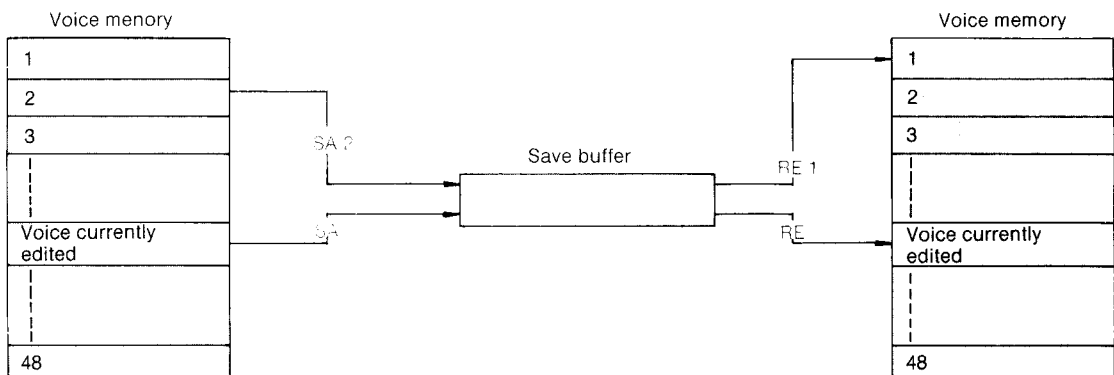
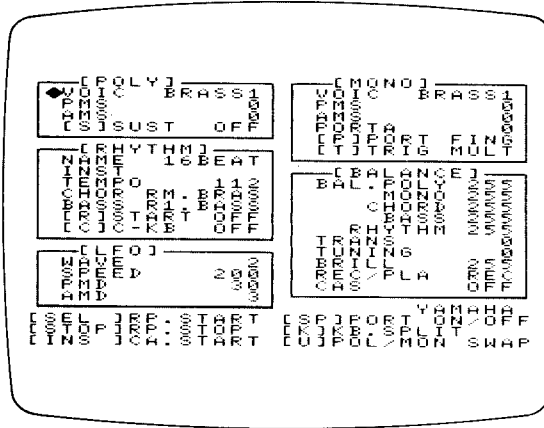







Fig. 21 The Keyboard function display (for SFG-01)



### SP a (SELECT PRINTER a)

This command sets the system in order to match the printer in use. In addition to the standard MSX printer, a printer having EPSON standards can also be used with the FM Voicing Program II.

Printer	a
MSX	1
EPSON	2

### TR (TRANSMISSION OF DATA)

This command displays the Filer and prepares the system to accept the specific commands which are used for saving and loading.

Fig. 22 The Filer

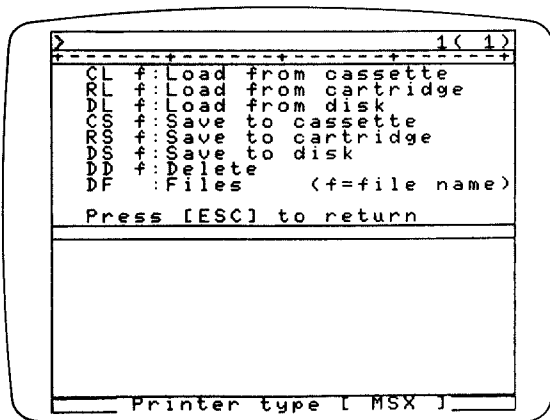

(with SFG-05 or SFK-05  
and disk drive connected)

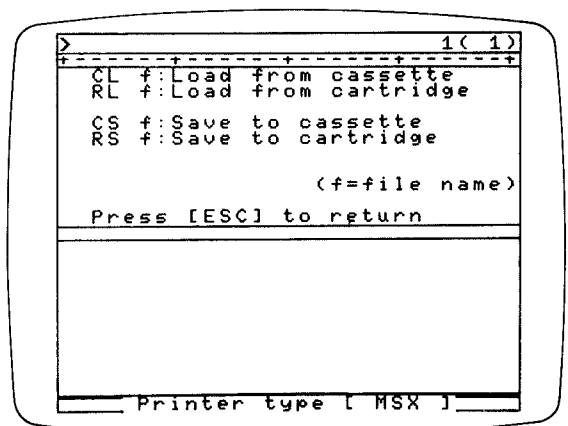

(with other Synthesizer unit or  
when disk drive is not connected)

## FILE MODE

The File mode only accepts the commands displayed in its menu.

This menu differs according to the Synthesizer unit in use (see Fig. 22).

- ★ The device used for permanent storage (cassette recorder, floppy disk drive, Data Memory Cartridge) must be connected before you turn the power to the computer ON.
- ★ Only one disk drive can be used..
- ★ A floppy disk drive unit cannot be used with Synthesizer unit other than SFG-05 or SFK-05.

### Cassette recorder

#### Saving

- (1) Press the playback and record button of the cassette recorder.
- (2) Type in the CS command, one space, the file name, then press **RETURN**. The message Sure? appears.
- (3) Press **Y** or **RETURN** to save the data. To cancel the command, press any other key.
- (4) When saving is completed, press the STOP button of the recorder.

#### Loading

- (1) Position the tape at the beginning of the file to be loaded or rewind it completely.
- (2) Type in the CL command, one space, the filename, then press **RETURN**. The message Sure? appears.
- (3) Press **Y** or **RETURN**, then press the playback button of the recorder. Press any other key to cancel the function.
- (4) When loading is completed, the new Directory is displayed. Press the stop button of the recorder.
  - ★ The Filer re-appears after you press any key when the Directory is displayed.
  - ★ The tape will run until the specified filename is found. Any other file name encountered on the tape is displayed in the lower area of the Filer.
  - ★ You may interrupt loading by pressing **CTRL** + **STOP**.
  - ★ If you omit to specify a file name, the first data file encountered on the tape is loaded.

### Data Memory Cartridge (UDC-01)

#### Saving

- (1) Type in the RS command, one space, the file name, then press **RETURN**. The message Sure? appears.
- (2) Press **Y** or **RETURN** to save the data, or another key to cancel the command.
  - ★ You may save only one file on the same cartridge. Saving a second file will erase the previous one.

## Loading

- (1) Type in the RL command, one space, the file name, then press **RETURN**. The message *Sure?* appears.
- (2) Press **Y** or **RETURN** to load the data, or another key to cancel the command.
  - ★ Data will be saved even if you omit the file name.
  - ★ If the specified file name differs from the file name recorded on the cartridge, the data is not loaded, but the recorded file name is displayed in the lower portion of the Filer.
  - ★ When loading is completed, the new Directory is displayed. Press any key and the Filer re-appears.

## *Floppy disk drive*

Used with SFG-05 and SFK-05 only.

## Saving

- (1) Type in the DS command, one space, the filename, then press **RETURN**. The message *Sure?* appears.
- (2) Press **Y** or **RETURN** to save the data, or another key to cancel the command.
  - ★ The device name *VOG* must be attached to the filename.
  - ★ Use the *FORMAT* instruction of the MSX BASIC to format the disk before trying to save data on a new disk.

## Loading

- (1) Type in the DL command, one space, and the file name, then press **RETURN**. The message *Sure?* appears.
- (2) Press **Y** or **RETURN** to load the data of the specified filename, or another key to cancel the command.

## Deleting

This is used to erase a file from the disk.

- (1) Type in the DD command, one space, and the file name, then press **RETURN**. The message *Sure?* appears.
- (2) Press **Y** or **RETURN** to delete the data of the specified file name, or another key to cancel the command.

## File list

This command displays the list of data stored in the floppy disk.

- (1) Type in the DF command, one space and a file name, then press **RETURN**. *Next?* appears when there are too many file names to display in the lower portion of the Filer.
- (2) Press **Y** or **RETURN** to go ahead with the list, or another key to cancel the command.
  - ★ Only the names of those files containing voice data are displayed. Files containing other kinds of data are not displayed.

## EDIT MODE

The main feature of the FM Voicing Program II is its edit mode, which is used to create sounds. The various functions of this mode are explained below.

### Switching to the edit mode

The FM Voicing Program automatically enters the command mode when the power is turned on. Let's assume you are going to edit the BRASS 1 voice, located in voice memory number one. While the computer is still in the command mode, type in 1 and press the **RETURN** key. The voice data of BRASS 1 will be displayed, but the cursor still remains in command mode. To enter edit mode, press **F1**.

- ★ If you press **F1** when the system is in Command mode, the main display will always re-appear, with the data of the currently edited voice. The cursor is located on the algorithm setting area.
- ★ Pressing the **←** or **→** cursor keys when the system is in Command mode switches to the main display without exiting the Command mode. The voice number of the data is increased (**→**) or decreased (**←**) by one.

The display of the voice data is divided into five blocks. The lower four blocks correspond to the four operators and display the data (parameters) for setting each operator.

Fig. 23 Edit area blocks

<input type="checkbox"/> <b>Overall settings</b>	
<input type="checkbox"/> Operator 1	<input type="checkbox"/> Operator 2
<input type="checkbox"/> Operator 3	<input type="checkbox"/> Operator 4

### Editing

- (1) Use the cursor keys to move the cursor to the parameter to be edited.
- (2) Use the **HOME**, **INS** and **DEL** key to alter the value.

Key	Change
<b>HOME</b>	- 1
<b>DEL</b>	+ 1
<b>INS</b> + <b>HOME</b>	- 10 (or minimum value)
<b>INS</b> + <b>DEL</b>	+ 10 (or maximum value)

You may also alter a parameter by moving the cursor over it, and then typing in a new value. In this case, the new value is entered after you press **RETURN** or after you move the cursor to another area.

- ★ To change the voice name, move the cursor to that name and type a new name. The **BS** key erases one character to the left; the space bar creates a blank space. Pressing the **RETURN** key moves the cursor back to the beginning of the name.

## Parameters

### Algorithms (Al)

This selects the algorithm from the eight algorithm patterns available. Select the number of the desired algorithm after moving the cursor to the Al position. Changing the algorithm can cause a significant change in the voice. The various algorithm patterns have the configurations shown in the following diagram. An operator functions as a modulator when its output goes to another operator, and as a carrier when its signals are output directly. A general rule of algorithms is that the fewer carriers there are (thus the more modulators), the more complex the voice will become, and the easier it will be to create noise components (broad band frequency spectra).

Fig. 24 Algorithm patterns of the FM Sound Synthesizer unit

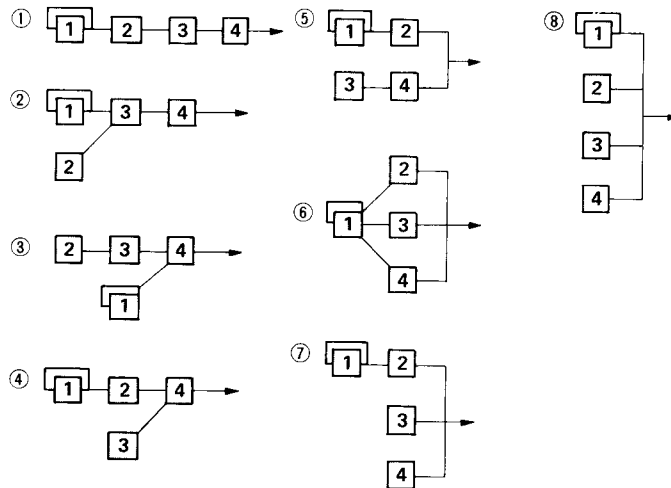

### Feedback (Fb)

Operator 1 has a feedback feature which allows that operator to modulate itself. The high-frequency components will increase and the voice will change considerably as the amount of feedback increases. The amount of feedback can be set within the range of 0 to 7. You may check the effect of the feedback by using algorithm 8 and turning operators 2, 3, and 4 OFF.

Fig. 25 Feedback

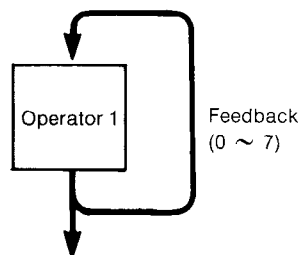

## Operator ON/OFF

Each of the four operators can be switched ON/OFF during editing so you can quickly hear the effect of cutting the output of an operator. Switching is done by pressing the number key corresponding to the desired operator ( [1] ~ [4] ) while holding down the [CTRL] key. For example, operator one can be turned OFF by pressing the [1] key while the [CTRL] key is held down. When the [1] key is pressed, the color of its indicators will be reversed both in the algorithm pattern and in the heading of its data block, and the operator function will be suspended. The operator can be turned back ON by pressing the [1] and [CTRL] keys again in the prescribed manner.

- ★ An operator can also be turned OFF by moving the cursor over its number in the operator block, and then pressing [HOME]. Pressing [DEL] will turn it ON. You may also move the cursor over the operator number and type in a different number to turn it OFF or the correct number to turn it ON. Such a change is actually entered after you press the [RETURN] key or move the cursor away from the operator number.

Fig. 26 Operators ON/OFF

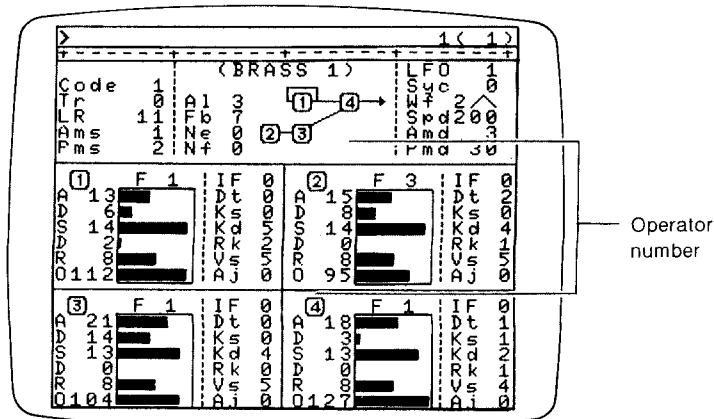

- ★ An operator is functioning when the background color of its indicator is yellow; it is not functioning when the background is inverted and becomes black.

**NOTE:** Sound does not pass through an operator that is OFF. Therefore, if you turn OFF a carrier you will not hear the modulators connected to the carrier. Similarly, if you turn OFF a modulator that feeds into a carrier, any modulator feeding that modulator will have no effect.

Let's analyze the voice data for BRASS 1 by using this operator ON/OFF feature. The algorithm pattern is 3 which means that operators one to three are modulators, while operator four is a carrier. Turn OFF operators one to three and play a few notes. You are listening only to the carrier (operator four). The pure sound that you hear is the sound of an unmodulated sine wave. Turn ON operators one to three in reverse order (3, 2, 1) and listen to how the sound changes after you turn each operator on.

## Output level of operator (O and Aj)

- O (Output level)

This sets the output level of the operators. With the FM Sound Generation system, the volume and the timbre will change according to the output level of the operators.

The setting range is 0 (minimum) to 127 (maximum). Try changing the output level of BRASS 1 with operators two and three OFF. First change the output level of operator four (default setting is 127). This will change the volume because operator four is the carrier. Next, change the output level of operator one (default is 112).

Operator one is modulator, thus the output level affects the degree of modulation. As the level is raised, the amount of modulation will increase and the sound will become more brilliant as the level and number of the harmonics increase. Increasing the output level of the modulator still further will cause the sound to become noise. Lowering the output level of the modulator will cause the sound to become more pure as the degree of modulation decreases. There will be no frequency modulation (if operator 3 is OFF), and the voice output will become a sine wave when the modulator output level drops to 0.

- Aj (Adjust)

The perceived volume or loudness of different voices will vary depending on the algorithm and the individual operator setting of each voice. In order to make different voices sound similar in volume, an output level "scaling" feature is included. This is called Adjust (Aj). Instead of changing the operator output level values for each operator in a voice, you change the Aj settings. Quiet voices cannot generally be made louder, but louder voices can be made quieter. The setting range is 0 to 15. In this case, 0 is the maximum output level and the output level of the operator will be decreased as the numeric value is increased. All carriers of a voice should be set to the same Aj value.

## Frequency of operator (F, IF, Dt)

- F (Frequency)

This sets the frequency of each operator as a ratio of the standard keyboard pitch. The setting range is 0 to 15. The keyboard frequency is halved when the value is 0. One is equal to the keyboard frequency (based on eight feet). Higher ratios create frequencies which are equal to the keyboard frequency multiplied by the ratio. For example, setting the value to eight will result in a frequency eight times higher.

F	Pressed key pitch ratio
0	0.5
1	1
·	·
·	·
·	·
15	15



- **IF (Inharmonic Frequency)**

This also sets the frequency of the operators but in terms of non-integer multiples or odd-numbered harmonics of the reference frequency. The setting range is 0 to 3 and the set frequency is determined as follows:

Set value	Frequency ratio
0	1 times the set ratio (1 x F)
1	1.41 times the set ratio (1.41 x F)
2	1.57 times the set ratio (1.57 x F)
3	1.73 times the set ratio (1.73 x F)

Thus, for example, if  $F = 2$  and  $IF = 3$ , the frequency will be  $2 \times 1.73$  or 3.46 times the keyboard pitch. Generally,  $IF$  will be set to 0 for most voices; high  $IF$  values are useful for creating unusual timbres.

*Table 3 Frequency ratio determined by  $F$  and  $IF$  settings*

$IF \backslash F$	0	1	2	3	4	5	6	7	8	9	10	11	12	13	14	15
0	0.50	1.00	2.00	3.00	4.00	5.00	6.00	7.00	8.00	9.00	10.00	11.00	12.00	13.00	14.00	15.00
1	0.71	1.41	2.82	4.33	5.64	7.05	8.46	9.87	11.28	12.69	14.10	15.51	16.92	18.33	19.74	21.15
2	0.79	1.57	3.14	4.71	6.28	7.85	9.42	10.99	12.56	14.13	15.70	17.27	18.84	20.41	21.98	23.55
3	0.87	1.73	3.46	5.19	6.92	8.56	10.38	12.11	13.84	15.57	17.30	19.03	20.76	22.49	24.22	25.95

Turn ON operators one and four only for BRASS 1 and listen to the changes in sound as the frequency ratio changes. The pitch will increase as the frequency of the modulator (operator one) increases, resulting in a more brilliant sound.

- **DT (Detune)**

This feature allows the sound to be modified by slightly shifting the pitch of the operators. The setting range of the operators is  $-3$  to  $3$  (0 is the normal setting). A sound effect similar to a phaser can sometimes be created by slightly shifting the pitches of the carrier and modulator. "Honky-tonk" piano is also aided by pitch detuning. Shifting the pitch of the carriers of algorithm patterns which have more than one carrier, such as algorithms 5 to 8, will allow the creation of a chorus-like effect.

## Envelope generator (A, D, S, D, R)

The envelope of each operator is set in the order A, D, S, D, R. The setting range of these components are as follows:

Screen display	Function	Setting range
A	ATTACK RATE	0 ~ 31
D	1st-DECAY RATE	0 ~ 31
S	SUSTAIN LEVEL	0 ~ 15
D	2nd-DECAY RATE </td <td>0 ~ 31</td>	0 ~ 31
R	RELEASE RATE	0 ~ 15

Fig. 27 The parameters controlled by envelope generator

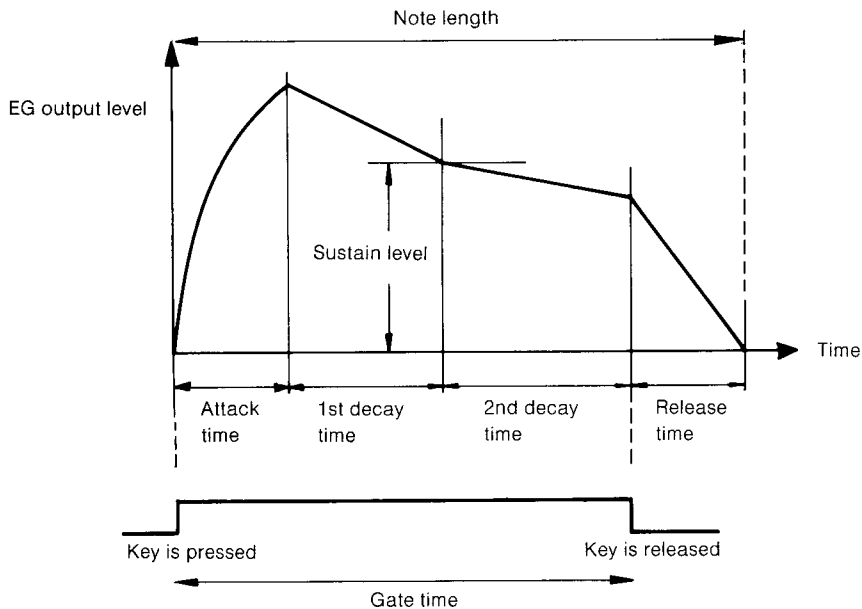

The RATE is the rate at which change occurs. Change will occur at a higher rate as the setting value becomes larger. An exception is that there will be no change if the RATE of the ATTACK, 1st DECAY, or 2nd DECAY is set at 0. For example, if A is set to 0, the EG output level will not rise for ATTACK (there will be no operator output). If the second D is 0, the output level will not fall for the second DECAY so the level will remain at the sustain level until the key is released.

Try various envelope combinations with only operator four ON. Alter values after moving the cursor to the A, D, S, D, and R of operator four.

## Key scaling (Ks, Kd, Rk)

This feature changes the EG response in relation to the pitch.

- **Ks (Key Scaling select)**

Choose either 0 or 1 as the level scaling curve (scaling in relation to EG output level). The value 0 decreases the output level as the pitch becomes higher (the “normal” setting); the value 1 decreases the output level as the pitch becomes lower.

Fig. 28 Key Scaling Select

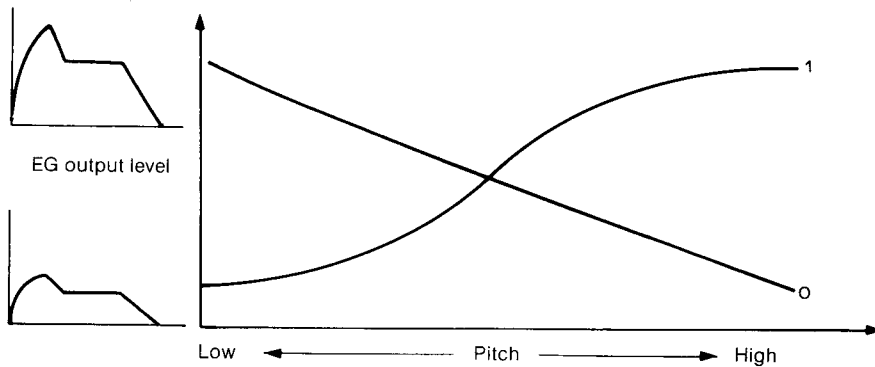

- **Kd (Key Scaling depth)**

This sets the amount of level scaling. The setting range is 0 (minimum) to 15 (maximum). The level scaling will increase or decrease the level as you move up and down the keyboard according to the curve set with Ks.

- **Rk (Rate Key Scaling Depth)**

This sets the amount of rate scaling (the EG rates change more rapidly as the keyboard pitch becomes higher). The setting range is 0 (no effect) to 3 (maximum rate scaling). This is not affected by the Ks setting.

Fig. 29 Rate Key Scaling Depth

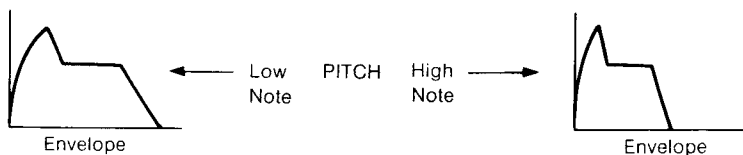

## LFO (LFO, Syc, Wf, Spd, Amd, Pmd, Ams, Pms)

The LFO (Low-Frequency Oscillator) generates very low frequency signals which are used to modify the voice. It allows the creation of vibrato and tremolo effects by changing the pitch and amplitude of the voice. The LFO section has several related parameters that all affect the voice.

- **Wf (Waveform)**

This selects the waveform of the LFO. The changes in pitch and/or amplitude (volume) will follow the selected waveform. The setting range is 0 to 3:

**Fig. 30 Wave form shapes**

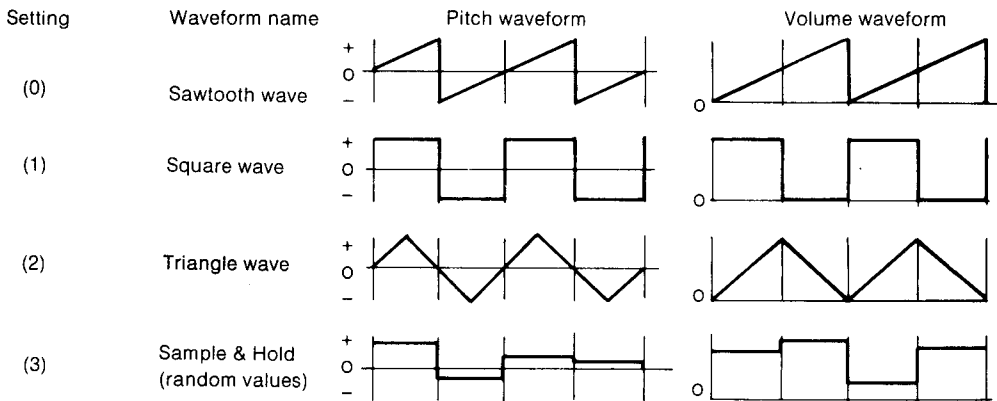

- **Spd (Speed)**

This sets the speed (frequency) of the LFO. The frequency can be set between approximately 0.008Hz and 53Hz. The LFO frequency becomes higher (more rapid changes) as the **Spd** value becomes larger. The setting range is 0 to 255.

**Fig. 31 Relationship between set Frequency value and LFO speed**

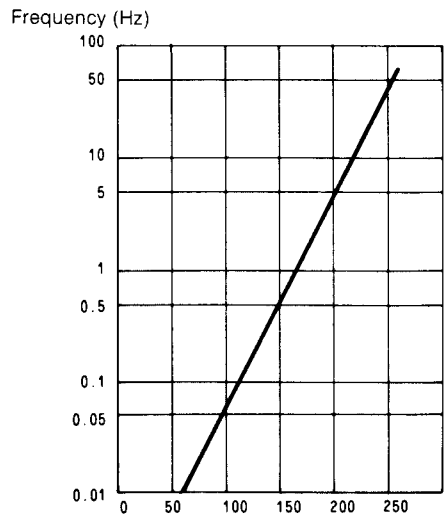

- **Amd (Amplitude Modulation Depth)**

This is a scaling factor which determines how much the LFO will affect volume (output level of the carrier). The setting range is 0 to 127. The depth increases (more volume change) as the Amd value becomes larger.

- **Pmd (Pitch Modulation Depth)**

This is a scaling factor which determines how much the LFO will affect the pitch of all operators. The setting range is 0 to 127. The depth (amount of pitch change) increases as the value becomes larger.

- **Syc (Sync)**

This sets whether or not the LFO is synchronized to the playing of a note. Pressing **[DEL]** activates synchronization, pressing **[HOME]** releases it. The Synchronization ON mode (1) means that the waveform of the LFO will re-start each time the key is played whereas a 0 setting may catch the LFO in the middle of a waveform. This is shown in the following diagram:

*Fig. 32 Starting point of the LFO*

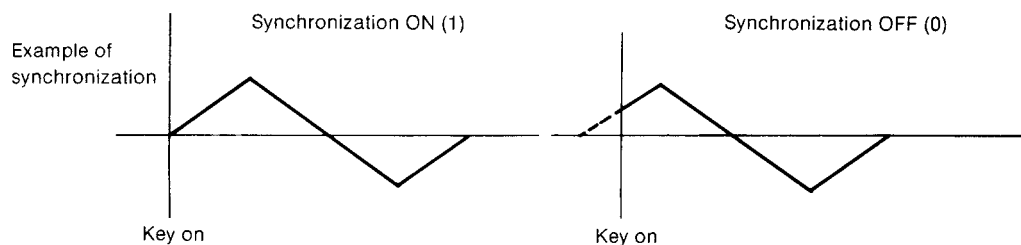

- **LFO (LFO Enable)**

The FM Sound Synthesizer unit is capable of simultaneous output of a maximum of eight voices. This means that each of the eight sound generators (called channels to distinguish them from the operators) may contain different voice data. Although there are eight channels, there is however only one LFO in the FM Sound Synthesizer Unit, and it can have only one voice-controlled setting at a time.

This may create difficulties at times, such as when you want to use the simultaneous output of "strings" which require the LFO, and percussion which does not use the LFO.

The synthesizer LFO will always be reset by the LFO data of the latest voice being played which could make it impossible to define the LFO data for strings when they follow percussion voices which do not use the LFO. This problem is solved through the use of the LFO Enable feature, which is usually set to 1 (ON). Setting it to 0 (OFF) will prevent LFO data, contained in the voice data, from being reset by a newly selected voice.

★ Software such as the Yamaha FM Music Composer (YRM-101) is needed for the simultaneous output of eight voices.

- **Ams (Amplitude Modulation Sensitivity)**

While the  $A_{md}$  setting determines how much LFO signal can be applied to the voice, it does not directly affect the voice.  $A_{md}$  signal must go through a “gate” known as  $A_{ms}$ . The sensitivity of the voice to amplitude modulation can thus be altered for proper response when a number of voices are simultaneously output.  $A_{ms}$  scales the voice’s LFO sensitivity to change the voice output level or volume. The setting range is 0 (no amplitude modulation) to 3 (maximum amplitude modulation).

- **Pms (Pitch Modulation Sensitivity)**

Once again, this is a “gate” or scaling factor, but it controls how much the set  $P_{md}$  will affect the voice’s pitch. The setting range is 0 (no pitch modulation) to 7 (maximum pitch modulation).

*Fig. 33 Block diagram showing the relationship between  $A_{md}$ ,  $P_{md}$ , and  $A_{ms}$ ,  $P_{ms}$ , for each channel*

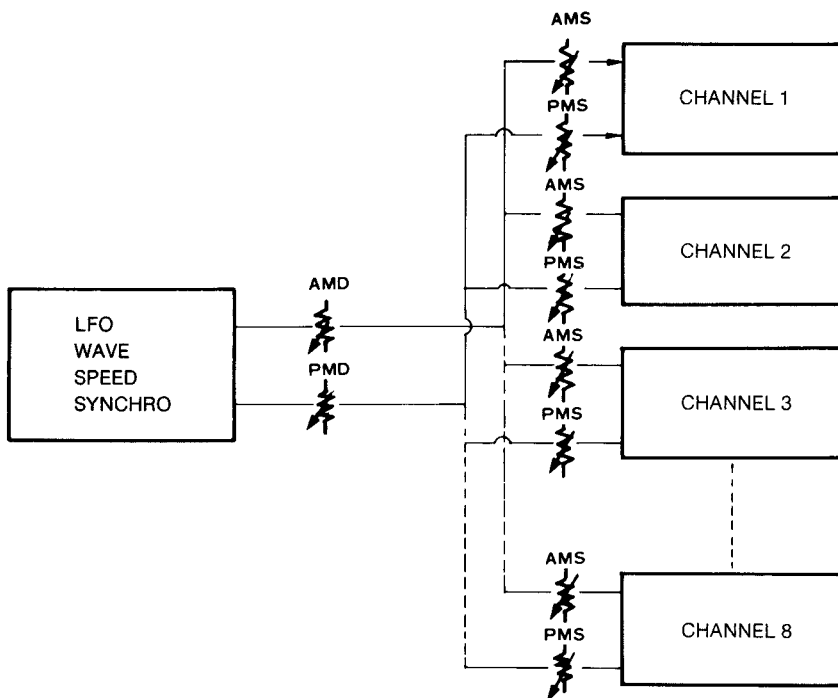

There will be no LFO effect in relation to pitch when either  $P_{md}$  or  $P_{ms}$  is 0. Similarly, there will be no LFO effect in relation to volume when either  $A_{md}$  or  $A_{ms}$  is 0.

## Velocity

The volume and timbre of the notes played on a piano will change when the keys are played harder (keys pressed down faster). Some synthesizers have an initial touch response feature to simulate these velocity-affected characteristics. These features normally monitor the speed at which the keys are played (velocity) and adjust volume and other factors accordingly. The FM Sound Synthesizer unit also has a feature which controls the volume and timbre in accordance with velocity data. The Music Keyboards (YK-01 and YK-10/20) have no ability to generate velocity data. However, velocity data can be generated during automatic program playback, or when a MIDI Keyboard is used to allow notes to be output from a velocity-sensitive DX synthesizer keyboard which then controls the computer's FM Sound Synthesizer unit.

The current strength of the velocity input data from MIDI or a remote keyboard is indicated on the keyboard split line by a yellow mark (\*). The (\*) mark will move when the velocity is changed. The velocity will become stronger as the mark moves to the right. The velocity data is normally set to the central value. The strength increases when the [F3] key is pressed and decreases when the [F2] key is pressed. These keys let you test the velocity sensitivity without having a velocity type keyboard.

Fig. 34 Velocity setting

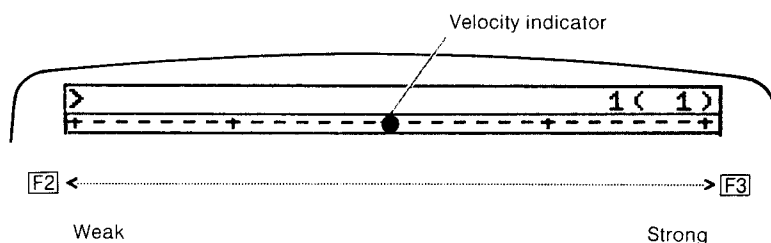

### • Vs (Velocity sensitivity)

This sets the operator's sensitivity to velocity data. In other words, it sets the degree to which the velocity data causes changes in the output level of the operator. Each operator can be set separately. Increasing the sensitivity of the carriers will cause changes in volume, whereas increasing the sensitivity of the modulators will cause changes in timbre. The setting range is 0 (no effect) to 7 (maximum sensitivity).

Fig. 35 Velocity sensitivity

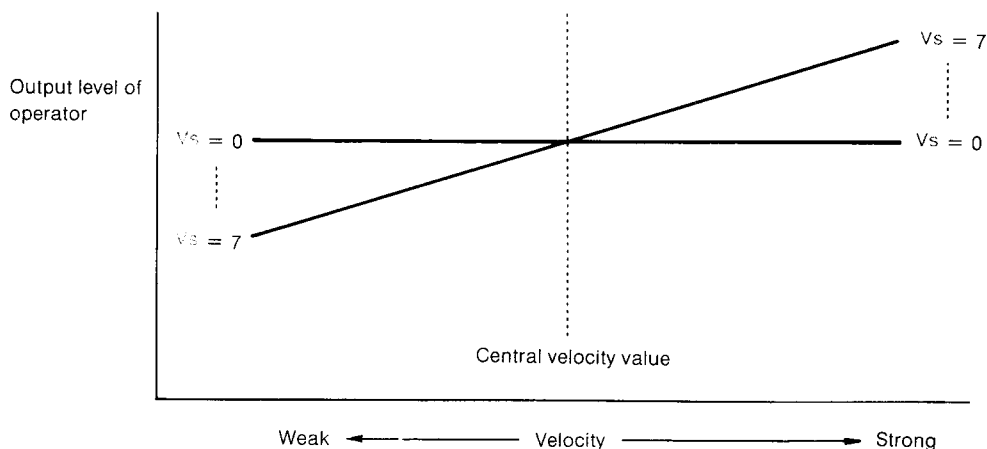

## Noise generator (Ne, Nf)

The FM Sound Synthesizer unit has 32 operators (8 voices x 4 operators) one of which can be used as a special noise generator or as a normal operator. The use of this noise generator is somewhat limited and can only be used for sound output of the section of the keyboard designed for comparison. The **[F4]** key must be pressed after each new value is input during editing to allow the editing results to be heard when the keyboard is played.

- **Ne (Noise Enable)**

This switches between the operator function and the noise generator function. The noise generator is selected when the value is 1. To cancel the noise function during an editing session, set this value to 0, then change the keyboard split point by pressing **[SELECT]** and playing a note on the keyboard, then press **[F4]**.

- **Nf (Noise Frequency)**

This selects the type of noise. The setting range is 0 to 31. The bandwidth of the noise will increase as the value increases. The set noise appears on one side of the split point when the saved voice is again loaded. This can be useful in conjunction with automatic playback.

## Additional parameters

- **Tr (Transpose)**

This allows transposing in half steps. The setting range is -128 to 127 (change this value by 12 to transpose one octave). If the transposed pitch of the note played exceeds the range of the sound generator, the FM Sound Synthesizer will raise or lower the actual pitch in one octave units as required. The transpose feature is very useful when you are using the keyboard for comparison. You may adjust the overall pitch of instrument-1 so that exactly the same pitches are available on instrument-1 and instrument-2.

- **LR (Left Right Switch)**

The FM Sound Synthesizer unit has stereo audio output jacks. Each jack can be selected (turned on/off) for each voice. 10 is input when output from only the left side is desired, and 01 is input for output only from the right. 11 specifies output from both jacks.

The input of 00 will result in no sound output.

<b>00</b>	<b>no output</b>
<b>10</b>	<b>left channel</b>
<b>01</b>	<b>right channel</b>
<b>11</b>	<b>both channels</b>



- Voice

There is a voice number displayed on the directory adjacent to each voice. The number appears in parentheses at the top of an initialized voice. A name of up to eight characters and numbers can be substituted in the parentheses, and will appear on the directory when the voice is saved. Use the **[BS]** key to correct any mistake made when entering the voice name.

- Code

Numeric data within the range of 0 to 99 having absolutely no affect on the voice data can be entered into the voices. This feature is useful for making personal memos such as to distinguish between voices having the same name or to mark that is the standard key for a percussion voice, etc. You can keep your own code list which defines, to you, what each code number means (the list is not a computer function).

### ***Other editing features***

#### **Loading the current voice to instrument-2**

During the editing, when you want to compare current editing data with anticipated voice settings, press **[F4]** to load the current settings to instrument-2 (lower keyboard section) and edit the same data to compare.

This is also used when you want to check the effect of the noise generator.

#### **Copying operators**

You may want to copy the data of an operator to another operator in order to save time.

- (1) Position the cursor over the data block of the operator to be copied.
- (2) Press the **[TAB]** key. The message **OP copy n** appears in the command area. *n* is the number of the operator to be copied.
- (3) Type in the number of the destination operator and press **[RETURN]**.

#### **Restoring an operator**

You may restore an operator in the state it was before copy (see above).

- (1) Press **[CTRL] + [TAB]**. The message **Restore op n?** appears in the command area. *n* is the number of the last operator whose data had been altered by a copy (see above).
- (2) Press **[Y]** or **[RETURN]** to restore the operator. Pressing another key will cancel the function.
  - ★ You may only restore the last operator altered by a copy.
  - ★ This will work even if you modified the data of the last operator obtained by copy.

#### **Saving a voice in the temporary memory (buffer)**

Pressing **[CTRL] + [S]** has the same effect as the **SA** command.

#### **Restoring a voice**

Pressing **[CTRL] + [R]** has the same effect as the **RA** command.

# KEYBOARD SPLIT FEATURE

The music keyboard can be split at any note into two sections: one for editing and the other for comparison. The section of the keyboard designated for editing can be played to allow you to hear the effect of modified voice data as it is entered for the purpose of checking. The voice sounded by the comparison section of the keyboard will remain unchanged until you reset that section. This allows sound creation to be carried out in the edit mode while comparing the previous voice on the comparison section to the new voice on the editing section.

## **Keyboard for editing**

(displayed on command and special-function tables as Instrument — 1)

The section of the keyboard above the split point is designated for editing; it can output a maximum of seven voices simultaneously. The voice data specified when the edit mode is first selected is the voice which is automatically set for this portion of the keyboard.

*Fig. 36 Keyboard for editing*

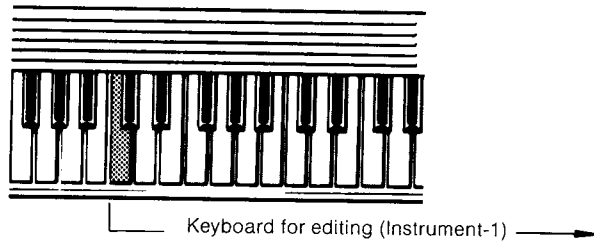

## **Keyboard for comparison**

(displayed on command and special-function tables as Instrument — 2)

The section below the keyboard split point is a monophonic keyboard to be used for comparison purposes. The current voice data is set for this keyboard by pressing the **F4** key in the edit mode.

*Fig. 37 Keyboard for comparison*

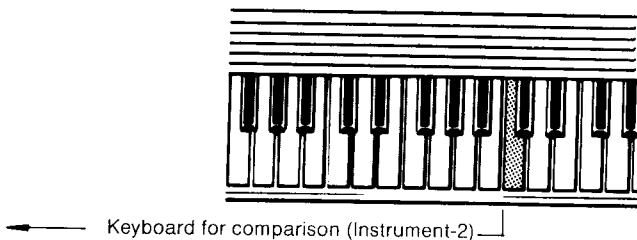

## Setting the keyboard split point

The keyboard split point is automatically set as the lowest key on the keyboard when the program is started. In other words, the keyboard for editing uses all the keys on the keyboard. To change the split point, first press the **SELECT** key. The color of the (\*) indicator on the line directly below the command area will change from green to red. Next, press the key on the keyboard corresponding to the desired split point. The red (\*) indicator will return to its original green color and move to the selected position. The green mark indicates the current position of the keyboard split point. The C on the line shows the position of C notes on the keyboard to provide you with a relative index of the key position.

Fig. 38 Keyboard split indicator

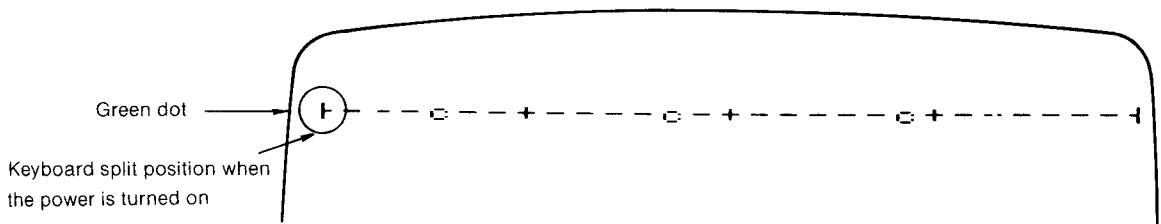
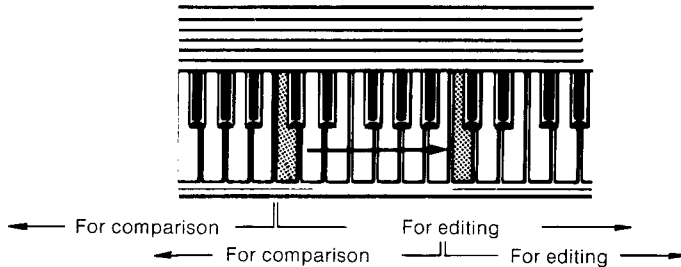

Fig. 39 Example of change of the keyboard split point



# **CHAPTER IV**

## **CREATING VOICES**

# THE BASICS OF VOICE CREATION

## Basics of voice creation using FM sound generation

The most simple algorithm possible for use with FM Sound Generation is one having a single carrier and a single modulator. The first step is to master the basics of voice creation using only this simple algorithm. Of course, all 8 algorithms available have 4 operators, so you will have to simply use 2 of the 4. The "unused" operators can be turned off during editing by pressing **CTRL** plus the number of the operator. For permanent disabling of an operator, set the output level (○) to zero (0). The waveform of the sound can be altered by the manipulation of the parameters of the algorithm. The following items may be altered to obtain major changes in the sound:

Table 3 The fundamental parameters of a sound

Item	Abbreviation in the FM Voicing Program	min setting	Sound change	max setting
Output level of carrier	○ (output level) of each operator	0 ←		→ 127
Output level of modulator		0 ←		→ 127
Feedback level	Fb (Feedback Level)	0 ←		→ 7
Carrier frequency	F (frequency) and IF (Odd-Harmonic Frequency) of each operator	0.50 ←	F	→ 15
Modulator frequency		0.50 ←	IF	→ 25.95
		0.50 ←	F	→ 15
		0.50 ←	IF	→ 25.95

The frequency of the modulator and carrier shown is not the set value. It is, instead, the final frequency ratio determined by F and IF (refer to page 30). The following items are the same.

Skillful manipulation of the above parameters allows the use of the FM Sound Generation section for determining pitch, timbre and volume.

### Algorithm

If you are not already there, press **F1** to return to the command window and clear the data of voice number one using **K1**, then switch the unit to the EDIT mode (by pressing **F1** key). Enter the following data:

<b>Algorithm → 5</b> <b>OP1, 2 → ON</b> <b>OP3, 4 → OFF</b>
---

(OP is the abbreviation for operator)

### Output level of carrier

This can be considered to be the audio signal volume control because the carrier output is converted to an audio signal output.

**OP2 Output level → 0 ~ 127**

### Output level of modulator

In the FM Sound Generation process, the modulator output signal modulates the carrier to produce harmonics which did not exist in the original carrier. This creates the tone or timbre and thus the output level of the modulator can be considered to be equivalent to the timbre control. (This is an over simplification of this process as modulators can affect volume, and carriers can affect timbre.)

**OP1 Output level → 0 ~ 127**

Raising the output level of OP 1 (modulator) will cause the generation of brighter voices.

### Feedback level of an operator

Feedback means that the operator (always OP1 in the FM Sound Synthesizer Unit) is frequency modulating itself. Applying feedback to the carrier (OP1 is a carrier in algorithm 8), will affect timbre in almost the same way as adjusting the output level of a modulator. However the modulator has this function in most algorithms. When feedback is applied to operator 1 and that operator is serving as a modulator (as it does in algorithm 5) , the additional modulation will further strengthen the effect of that operator and you may wish to lower its output level.

**Feedback level → 0 ~ 7**

Setting the output of the modulator to a high level (more than 115) and then increasing the feedback level (assuming OP1 is a modulator) will tend to generate noise. The noise components will vary according to the set modulator frequency. The same effect can be obtained by employing up to three modulators in series with one carrier and setting the output of each modulator to a high level.

### Carrier frequency

The carrier output is converted to the actual audio signals. When there is one carrier, the pitch of the audio signal is determined primarily by the carrier frequency (modulators can affect this, too). What happens when there are two carriers? The following example uses OP4 as well to answer that question.

**OP2 → ON  
OP4 → ON  
OP1, 3 → OFF**

The following three effects can be created by altering the ratio between the pitch of the two carriers.

- When the pitch ratio of the two carriers is set to low integers (1:1 through 1:6)

**OP2 Frequency → 0 ~ 6  
OP4 Frequency → 1**

The pitch of the two carriers will harmonize to create a new voice (as does the coupler effect of an organ). In this case, the carrier having the lower frequency determines the perceived pitch.

- When the pitch ratio of the two carriers is set to high integers (1:7 through 1:15)

**OP2 Frequency → 7 ~ 15**

The pitch of the two carriers is far apart and two separate sounds can be heard: a high one and a low one. If the pitch ratio does not have harmonics of 2, 3 or 5 (for example 1:7), the pitch of the two carriers will not harmonize and a dissonant sound will be heard.

- When the ratio is a non-integer

**OP2 Frequency → 1**  
**OP2 IF value → 1 ~ 3**

The pitch ratio can be made to be a non-integer through the use of the Odd-Harmonic Frequency feature. There will be absolutely no harmonization and the sound will seem to come from two separate sources.

Voice effects which can be created by altering the pitch ratio of the carriers

Pitch ratio	Effect
Low integer 1:1 ~ 1:6	Perfect harmonization of the two carriers A new voice is created (Coupler effect)
High integer 1:7 ~ 1:30 (= 0.5:15)	The two sounds seem separated
Non-integer 1:1.41 ~ 1:51.9 (= 0.5:25.95)	The two sounds are totally separate

### Modulator frequency

The modulator is the signal which, when fed into the carrier, creates harmonics which were not in the original carrier. This produces the timbre characteristics of various voices. The modulator frequency (or, more correctly, the frequency ratio in relation to the carrier) determines the frequency of the harmonics to be produced. The modulator output level determines the relative level of each harmonic. A feel for the use of this function is very important when creating original voices.

**AI → 5**  
**OP1, 2 → ON**  
**OP3, 4 → OFF**  
**OP1 Output level → 115**  
**Feedback level → 0**

- When the pitch of the modulator is higher than that of the carrier

Leave the pitch of the carrier (OP 2) at 1 and raise the pitch of the modulator (OP 1).

**OP1 Frequency (F) → 0 ~ 15**  
**OP1 IF value → 0 ~ 3**

Moderately increasing the frequency of the modulator (raising the pitch ratio in relation to the carrier) will cause the generation of higher-frequency harmonics and a brighter tone. Further increases will create higher harmonics while simultaneously creating harmonics lower than the carrier pitch. As the pitch ratio of the modulator to the carrier approaches the maximum, the normal pitch relationship may be destroyed and the timbre may suddenly change to a new one. This effect is created when the higher harmonics extend beyond the audible range and the lower pitch takes over the control of the pitch effects.

- When the pitch of the modulator is lower than that of the carrier

This permits the creation of various effects through the manipulation of the carrier (OP2 in this case).

**OP1 Frequency → 0**  
**OP1 IF value → 0**  
**OP2 Frequency → 0 ~ 15**  
**OP2 IF value → 0 ~ 3**

### ***The concept of algorithms***

Algorithms affect a great number of voice attributes. The algorithm currently being used for experimentation can create a large number of voices, but even more can be created with different algorithms. For the sake of clarity, the following description classifies algorithms by the number of carriers they contain.

#### **Algorithms having one carrier (1 — 4)**

When one of the operators is being used as a carrier, the rest may function as modulators. This means that bright sounds will probably be produced. Switching between the algorithms and comparing the generated voices will show that algorithm patterns having one carrier are used for the brightest sounds.

**OP1 ~ 4 Output level → 110**  
**Feedback level → 0**  
**Algorithm → 1 ~ 4**

When algorithm one is selected, setting the feedback and output levels of all the operators at their maximum, produces a voice containing excessive noise components.

**Algorithm → 1**  
**OP1 ~ 4 Output level → 127**  
**Feedback level → 7**  
**OP4 Frequency → 15**  
**OP4 IF value → 3**



---

This sound is called white noise. There is absolutely no pitch created by the carrier because all frequencies are present already. White noise means that noise components are randomly generated across the entire audio frequency range. This is similar to the sound of hiss when you blow through closed teeth, or the sound of the wind. (Analog synthesizers use a special noise generator to create this sound.)

Algorithm patterns using one carrier can be used to create voices having extreme harmonics, but subtle voices having complex waveforms can also be generated. It depends on the specific value selected for the output level of each modulator. This kind of algorithm is most appropriate for the creation of single instrument sounds.

### **Algorithms having two carriers (5)**

This type of algorithm is an all-purpose pattern which permits a wide variety of voices to be created. Elaborate voices can be produced because there are two modulators in addition to the two carriers. Shifting the pitch of the two carriers can create a chorus effect, or the algorithm can be divided into two halves, each with completely different sounds, for more complex voices. For example, algorithm five can be used to create a flute voice. Operators three and four can be used to create the basic flute "pure tone" sound, while operators one and two add a breathy character.

### **Algorithms having three or four carriers (6 — 8)**

This type of algorithm pattern is used for the creation of rich and textured voices. For example, shifting the pitch of each carrier slightly will result in a chorus effect similar to the sound of a number of instruments being played simultaneously. Select algorithm eight and use the DETUNE feature to slightly shift the pitch of each of the four carriers relative to each other. This allows the creation of an ensemble (string, vocal, etc.). Algorithms, such as number eight which has four carriers, are perfect for the creation of organ-like voices through the coupler effect.

## ***The concept of voice creation***

The following is an actual example how to create a voice from scratch. The example used is the creation of the voice of an electronic piano.

### **Voice creation flow chart**

There are a number of different procedures for the creation of voices. The approach outlined below is a reasonable way to proceed.

Operation	Parameter of FM Voicing Program
1 Initialization of voice data	KI command
2 Selection of algorithm	AI
3 Setting of operator frequency	$\omega$ and IF
4 Setting output level of operators	O
5 Setting	EG A, D, S, D and R
6 Setting of key scaling	Ks, Kd and Rk
7 Re-adjustment of voice data	
8 Adding effects	LFO, Dt and Vs

### Initialization of voice data

Initialize voice number one by using the KILL command. This is done by entering KI 1 followed by **RETURN**. Initialization of voice data means that the voice data is set to a state which can be likened to that of a blank sheet of paper. This does not mean there is no data but, instead, it means that there are certain parameters which create a "pure" sound which is then edited to obtain the desired voice.

### Selection of algorithm

After the voice data has been initialized (using **F1**, then KI 1), switch from the command mode to the edit mode. Voice number 1 was initialized so 1 is entered and the **RETURN** key pressed. The initialized voice data from voice 1 will be displayed on the screen. Algorithm 8 is selected for the initial voice. A different algorithm which is more suitable for the sound of an electronic piano is selected. Set AI to 5 for the selection of algorithm 5. This algorithm pattern has two carriers, is easy to use, and allows the creation of a relatively wide variety of sounds. In this example, OP1 and 2 are used for the main piano tone while OP3 and 4 are used to create a metallic echo-like "tine" sound.

Fig. 40 Algorithm

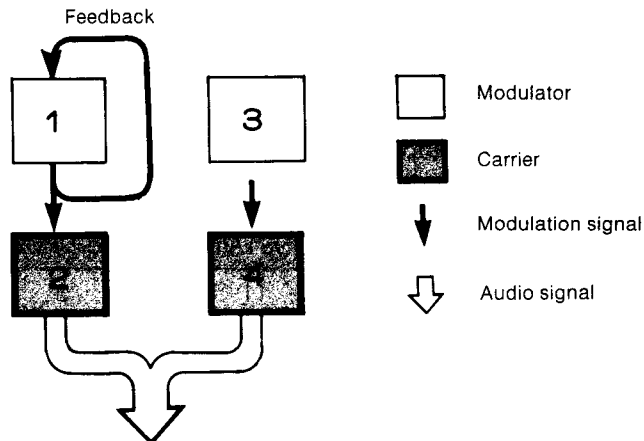

### Setting of operator frequency

The next step is to set the frequency of each of the operators. The frequency can be set by F and jF, but in this example only F is set. The frequency of OP3, which is the modulator of OP4, is set to 10 in order to create a metallic ring. The other operators are all left at 1.

### Setting output level of operators

This step alters the output level of the modulators to adjust the timbre. When adjusting the level of OP 1, set OP 3 and 4 to OFF ( **CTRL** + **3** , **CTRL** + **4** ) so that sound is output only from OP 1 and 2. Set OP 1 to about 115 for a fairly bright sound, and set OP 3 to 80 so the pitch sensitivity is not decreased and a metallic echo-like sound is produced. There is only feedback for OP1, and it is set to 2 in order to increase the brightness of the voice.

### Setting EG

It is now time to set the volume and timbre envelopes. This will transform the voice, which now sounds like an organ, into that of an electronic piano. OP 1 ~ 2 and OP 3 ~ 4 should be adjusted separately, then put together in the final stage to let you hear the total sound. OP 1 ~ 2 are adjusted first. The attack of this portion of the voice is given greater emphasis by altering the OP1 and OP2 envelopes. OP 1 is the modulator. There will be a greater number of harmonics, but only on the attack, after which the character of the voice changes very little.

	ATTACK	1st-DECAY	SUSTAIN	2nd-DECAY	RELEASE
OP1	31	15	13	0	6
OP2	31	12	13	15	8

Fig. 41 Envelop shape for OP1 and OP2

EG of OP1

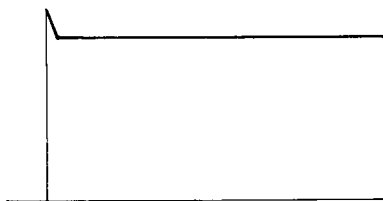

EG of OP2

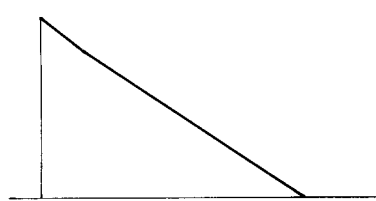

The settings of OP3 and of 4 are adjusted next. This is the metallic echo effect, so an envelope sharper than that of OP1 and 2 is desired. The setting of the carrier (OP4) is the same as that for OP2, and is adjusted later by key scaling. Set the envelope of the modulator (OP3) so that there is relatively little change in the character of the voice.

	ATTACK	1st-DECAY	SUSTAIN	2nd-DECAY	RELEASE
OP3	31	7	11	3	6
OP4	31	12	13	5	8

Fig. 42 Envelop shape for OP3 and OP4

EG of OP3

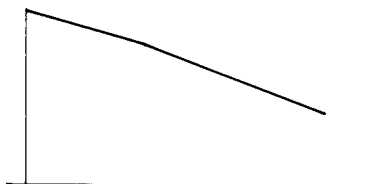

EG of OP4

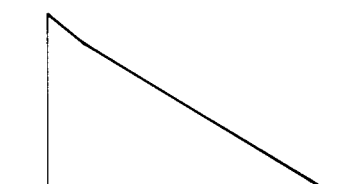

### Key scaling

The above setting will create a voice very similar to that of an electronic piano. Next, use key scaling to shorten the high notes and compensate for the high timbre notes which are too bright. Rate scaling adjusts the attack and release times of the notes, while level scaling is used for tonal character and volume. The level scaling curve is 0 in order to reduce the intensity of higher pitched sounds.

	Ks	Kd	Rk
OP1	0	6	2
OP2	0	3	2
OP3	0	6	6
OP4	0	4	3

The use of this key scaling procedure to edit the envelope shortens the overall length of the envelope across the keyboard, through more or higher notes. The original EG settings were selected with this scaling in mind. The length of the envelopes can be adjusted by the individual operator EG settings.

### Re-adjustment of voice data

The setting of the voice components is now complete. However slight changes in almost any setting such as the EG, can still change the voice. The final voice can be "fine tuned" by the adjusting the output level of the operators and the level of feedback. For example, if you think the metallic echo is too strong, the output level of operator four can be reduced. There will be cases where the maximum or minimum frequency of the operators is exceeded and the sound will thus automatically be lowered or raised by one octave. This is changed manually by the transposing (Tr) feature.

The volume is more likely to become too high in cases where there are two carriers, such as in the example given here, compared to when there is only one carrier. Thus, sometimes you will want to lower the volume while considering the balance between the carriers. The adjust feature (Aj) is useful for this. Setting only the Aj of the carriers allows the total volume to be adjusted without changing the balance between the carriers.

## Adding of effects

Effects such as tremolo or chorus are added in this final step to make the created voice resemble that of an electronic piano even more.

The tremolo effect is added by the use of the LFO. Set the the LFO to 1, then select waveform two (triangle wave) for a moderate tremolo effect. The speed is then set to an appropriate setting of approximately 190 to 195. Use the Amd feature for setting the depth of the tremolo. There is a close relationship between the Ams and Amd features. Set Amd at 10, which gives little range to Ams. Change Ams to 1 for a very slight tremolo effect. Pmd and Pms are set to zero because this voice does not use a vibrato effect. The chorus effect is created by shifting one of the carriers slightly, and a phase effect is created by shifting one of the modulators slightly. This richer sound is sound is obtained by setting the Dt of OP 1 to -3 and the Dt of OP 4 to 3.

## Velocity sensitivity

Finally, since the voice created is that of a piano, set the velocity to control the volume and voice character. The simplest way to do this is to set the Vs of all the operators to 1.

The velocity data can be changed, and the sound checked by the use of the **F2** and **F3** keys. If you are using a Music Keyboard (YK-01 or YK-10/20). If you are using a MIDI Keyboard, the velocity sensitivity setting can be checked immediately.

## **SOME EXAMPLES OF SOUND CREATION**

There is a shortcut which can be used to create sounds much more easily. This is through the copying of existing voices. This is not simply wholesale imitation, but instead is the process of creating a new voice while checking it against the sound of an existing voice. It is often much easier to modify an existing voice to fit your image of some original sound you wish to create than to start from scratch. This section chooses a number of voices from those stored in the FM Sound Synthesizer unit and explains the process of sound creation after the voice has been initialized.

### ***The creation of brass voices***

Let's create a voice in the FM Sound Synthesizer unit from scratch. This example uses voice three (TRUMPET) as a base. Be sure to follow the following steps carefully when creating a voice from scratch.

#### **Algorithm**

The algorithm of BRASS 1 is 3. This pattern uses one carrier, and is perfect for the creation of brilliant brass sounds. The three modulators each with its own EG, permit the generation of a wide range of changes within the harmonic structure.

#### **Operator output level and Feedback**

The output level of the carrier OP4 can be left at 127. The output level of OP1 ~ 3 can be moderately adjusted within the range of 90 ~ 110. Feedback is very important for this voice and is set to its highest value(7).

#### **Frequency of operators**

The basic setting of all the operators can be 1. OP2 can be set to 2 for a slight metallic echo, further improving the sound of the brass instrument. The output level of OP2 is set at 94 for a very subtle sound.

#### **EG**

The EG is also very important for creating a brass voice. All of the operators have a slow attack. Set attack, or A, for the modulator (OP1) so that it is slightly slower than any of the carriers. This creates the special attack characteristic that brass instruments have. If carrier (OP4) attack is slower than the modulator attack, there will be no character change detectable in the attack section, and the sound will resemble that of an organ. The A data (attack) of the three modulators should all differ slightly to create even more realistic character changes.

#### **Key scaling**

The sharpness of the higher keys will be lost when a slow attack envelope is set. The rate scaling feature corrects this so that the voice sounds natural when fast passages are played. Rate scaling is set at 1 to 2 for all operators to preserve the rapid attacks of the higher notes of brass instruments.

#### **LFO**

With brass instruments, the pitch of notes played for a long time is going to waver no matter how good the musician is. This effect is emulated by the LFO. Set the vibrato effect to a barely detectable level (LFO assigned to pitch via Pmd and Pms).

Fig. 43 Settings for a brass voice

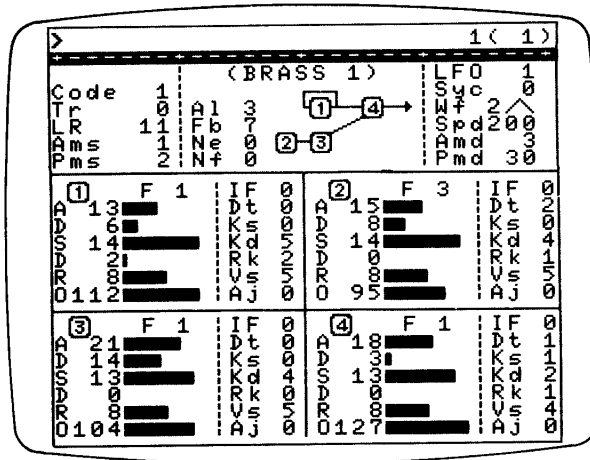

**The creation of string voices**

The next example uses as its base STRING 1, which is voice number 4.

**Algorithm**

Algorithm pattern 3 is also used for STRING 1. This has one carrier and three modulators, an algorithm used for voices having a high degree of character change. It is used in this example to reproduce the complex sounds of string instruments.

**Frequency of operators**

OP1, 3 and 4 remain at 1. The pitch of OP2 is set to 5 for creating the delicate texture associated with string instruments.

**Output level of operators and Feedback**

The output level of the modulator must not be too high. The appropriate setting is about 80 to 120. If the output level of the modulators is raised above this, the voice will begin to resemble that of a horn instrument, with some additional noise components. The feedback is used to reproduce the feeling of the vibrating string, and is set to 7.

**EG**

String instruments also have a slow attack, so that attack, or A, of the carrier is slowed down slightly by setting it between 13 and 15. The modulators are set faster than the carrier. The R (release) of the carrier is also slowed down slightly (5-6) to simulate the sound of an ensemble. This causes the sound to linger after the key has been released.

**LFO**

Vibrato is one the most important characteristics of string instruments. However, since this is an orchestral sound, there is no need for the deep vibrato heard with solo string instruments.

**Transposing**

Transposing lowers the pitch by one octave to obtain a richer middle and lower range sound.

Fig. 44 Settings for a string voice

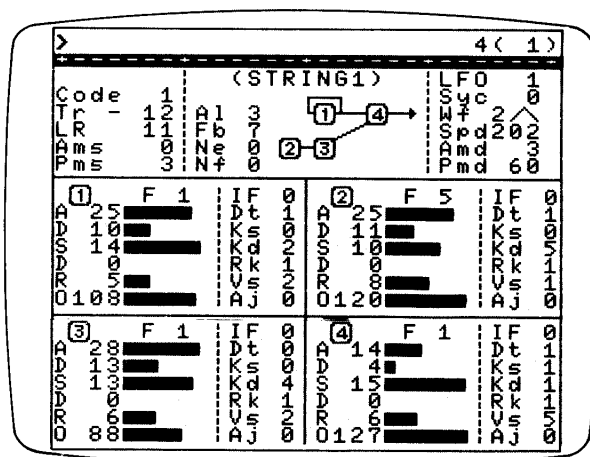

### The creation of pipe-organ voices

The final example uses PORGAN 1 which is voice number 14. This voice uses two carriers.

#### Algorithm

PORGAN 1 uses algorithm pattern 5, which has two carriers and two modulators. This "all-mighty" voice allows close control over the sound because the voice components can be divided into two parts. In this example, the voice is divided into the set of OP3 and 4, used for the deep reverberations of the pipe organ, and the set of OP1 and 2 for the high-frequency reverberations. Both of these can be programmed independently.

#### Frequency of operators

OP3 and 4 are set at 0 for the deep, low reverberations of the pipe organ. OP1 and 2 for the high-frequency reverberations of the organ are set to 8 and 4 respectively. The harmonic ratios are thus 1:2 and 4:8. This produces the couple effect of the organ (two pitches harmonizing to create a new sound).

#### Output level of the operators and feedback

Output level of the modulators must be prevented from becoming too high. There is no need for feedback.

#### EG

The attack of the pipe organ is probably not as slow as you think. If it is too slow, the sound will begin to resemble the old foot pedal-driven organs. The appropriate level of the A of the carrier is 16 to 18. Taking the construction of a pipe organ and the conditions of the hall where it played into account, together with the intention of causing some reverberation to remain after the keys are released, the R setting of both the carrier and modulator is between 5 and 7.

#### Key scaling

Rate scaling corrects the overly long reverberation that tends to occur after the higher keys are released. Level scaling is applied to the modulators and limits the frequency modulation on the higher keys for a clearer voice.





# APPENDIX

# INTRODUCTION TO THE FM SOUND SYNTHESIS

## Basic knowledge needed to create sound

A piano and a flute both cause air to vibrate, which we perceive as sound. Both can play an “A” at 440 Hz or so, depending on their tuning, yet each instrument has its distinctive sound. Differences in the way each instrument creates sounds are identifiable, and explain why they sound different. Synthesizers can be programmed to create sounds with similar pitches, but with different harmonic content, volume “envelopes”, and so forth — factors that aid in creating widely varied sounds.

The FM Voicing program II lets you create various sounds by controlling the factors which comprise and particular sound. Before the FM Voicing Program II can be fully enjoyed, the factors that govern the sound must be understood.

### What is sound?

Sound can be considered to originate from the vibration of a object. This vibration passes through the air and reaches our ears as “sound”. It is difficult to imagine the components of this sound because sound can not be perceived by the eye.

To help you visualize sound, a microphone can be used to convert the vibration of the air (changes in air pressure) into electric signals. These electric signals can then be converted into visual images by connecting the microphone to an oscilloscope. The visual images which appear on the screen of the oscilloscope are referred to as **waveforms**. This explanation will frequently refer to the term waveform. It is best to simply consider waveforms to be the same as the visual image of a wave.

Fig. 46 Visualisation of a waveform

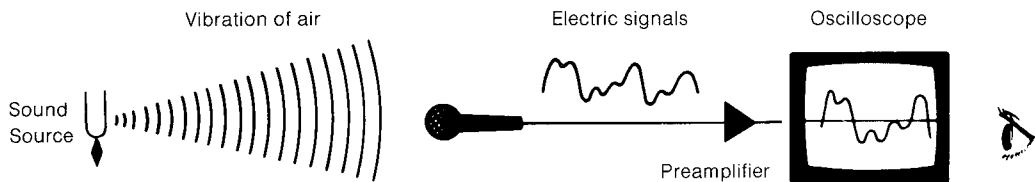

### The three components of sound

- The pitch

A piano or guitar produces a sound which has a fundamental frequency (or **pitch**) proportional to the length of the struck or plucked string. The pitch of the sound can be changed by altering the length of the vibrating section of the string. This alters the number of times that the string will vibrate in a given time period. For example, a low pitch means that the string is vibrating relatively slowly. This principle allows the pitch of the sound to be expressed in terms of the number of vibrations per second (frequency).

- The timbre

However, while the pitch of a certain note is the same for a piano and guitar, the waveform and tonal character (**timbre**) are quite different. This is determined by the way that the sound is generated. The size and shape of these instruments are going to result in the strings of the instruments vibrating differently. The way the vibration is produced can be expressed by a waveform. The shape of many musical instrument waveforms may appear at first glance to have no rhyme or reason to them, but actually

all waveforms are composites of sine waves. If we state this in reverse, a waveform of any shape desired can be created by combining sine waves together. For example, the diagram shows what happens when sine waves which are multiples (double, triple, etc.) of the original sine wave are added. The wave begins to resemble a saw tooth wave as higher-multiple sine waves are added to the original sine wave. The original sine wave is called the **fundamental** and subsequent sine waves are composed of differing **harmonics**. The tone or timbre (waveform) of an instrument is determined by the number and relative volume level of harmonics.

Fig. 47 Sawtooth waveform as a superposition of sine waveforms

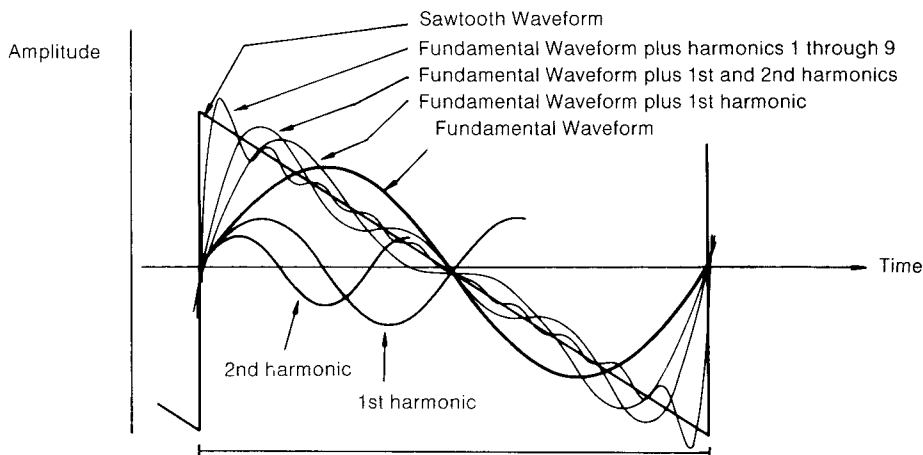

The following BASIC program will display the above diagram on your monitor screen, showing how addition of harmonics progressively approximates the sawtooth waveform. This program also allows for similar representation of square and triangular waveforms. To stop this program, press **CTRL** + **STOP**.

```

10 DIM W(160):P=ATN(1)/20:SCREEN 0:COLOR 15,4,7:PRINT"which waveform?":PRINT
20 PRINT"1= Saw tooth":PRINT"2=Square":PRINT"3=Triangle":PRINT:PRINT"1/2/3 ?":
30 A$=INPUT$(1):IF INSTR("123",A$)=0 THEN RUN 10 ELSE C=VAL(A$)
40 SCREEN 2:COLOR 15,4,7:OPEN"GRP:"AS1:H=0:N=1
50 ON C GOSUB 120,130,140:IF A<>0 THEN H=H+1:CLS:ON C GOSUB 170,180,190:ELSE 90
60 PRESET(16,180):PRINT#1,"Fundamental":;IF N>1 THEN PRINT#1,"+":H-1;"Harmonics"
70 GOSUB 200:PRESET(100,0):PRINT#1,"Hit Space Bar"
80 IF INKEY$<>CHR$(32) THEN 80
90 N=N+1:IF H<10 THEN 50 ELSE LINE(0,0)-STEP(255,8),4,BF
100 PRESET(16,0):PRINT#1,"Hit Space Bar to restart"
110 IF INKEY$=CHR$(32) THEN RUN 10 ELSE 110
120 A=2/N/P:RETURN
130 IF N MOD 2=0 THEN A=0 ELSE A=3/N/P:RETURN
140 IF N MOD 2=0 THEN A=0:RETURN:ELSE S=(N-1)/2
150 IF S MOD 2=0 THEN A=1 ELSE A=-1
160 A=A/10/(N*P)^2:RETURN
170 PSET(40,90):DRAW"U80 F160 U80 L160":RETURN
180 PSET(40,90):DRAW"U60 R80 D120 R80 U60 L160":RETURN
190 LINE(40,90)-STEP(160,0):LINE(40,90)-STEP(40,-80):LINE STEP(0,0)-STEP(80,160)
:LINE STEP(0,0)-STEP(40,-80):RETURN
200 F=0:FOR I=2 TO 160 STEP 2:HR=A*SIN(1*P*N):W(I)=W(I)+HR
210 PSET(40+I,90.5-HR):LINE(38+I,90.5-W(I-2))-(40+I,90.5-W(I)):NEXT:RETURN

```

The pitch of the sound is determined by the number of times per second (frequency) at which the fundamental vibrates. Strictly speaking, pitch is a subjective value and also depends on absolute volume level. We often use the term pitch when we are really concerned with the fundamental frequency.

- **The volume**

The amplitude of the vibrations (in the above example, the height of the sawtooth waveform) corresponds to the **volume** of the sound.

Thus, we can say that the subjective differences that we perceive in sounds are a product of the differences in pitch, tone, and volume. The three components of sound that affect these differences are the frequency of the fundamental, the waveform (or harmonic structure) and the amplitude.

### **Changes In sound over a period of time**

There is another principle which must be grasped regarding the differences in sound. When a note is played on, for example, a piano, an initial sound (attack) will be heard when the key is first struck. The sound will gradually change as the key is held down. In terms of volume, there is a sudden, loud initial sound which then gradually diminishes. In terms of harmonics, the beginning of the note will contain a large number of harmonics but the number will decrease as the note decays. Many complex changes occur in the note from the instant it is produced until the point where it decays to inaudibility. We refer to this relationship between time and the change in the sound as the “**envelope**”. This is very important from the viewpoint of sound creation because differences in the envelopes of two voices will result in two completely different voices even though the frequency of the fundamental and each harmonic may match exactly. There are envelopes for overall volume, as well as for harmonic structure. However, the harmonic envelope is nothing more than a series of volume envelopes: one for each individual harmonic.

*Fig. 48 Volume envelope model for the (harmonic envelope)*

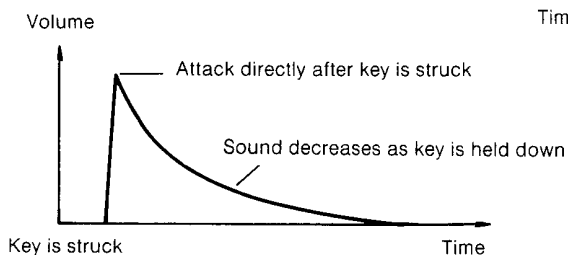

*Fig. 49 Voice envelope model fundamental of a piano note for a piano*

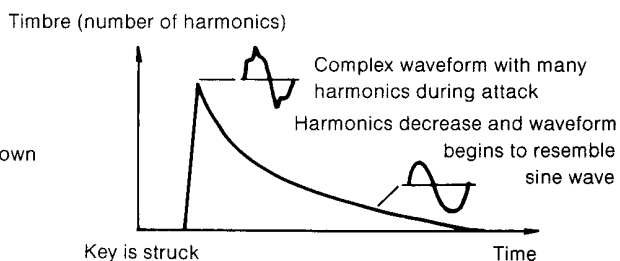

### **What is sound synthesis?**

The electric signals visualized in Fig. 46 can be re-converted into sound by using an amplifier/speaker system. Actually, an electric guitar is working according to this principle: the sound created by the string vibrations is converted into electric signals by microphones, then the electric signals are sent to an appropriate amplifier. This amplifier is provided with several control functions such a volume, tone, etc., allowing for an easy control of the output sound, that is impossible with acoustic instruments.

Sound synthesizers use a different method: electronic circuitry directly produces electric signals. Thus, a synthesizer does not produce sound by itself and, as a consequence, the electric signals generated by a synthesizer are completely free of ambient noises. A sound synthesizer essentially consists in a multitude of oscillators (circuits generating elementary waveforms) associated with several control functions allowing you to combine elementary waveforms in order to obtain a desired resulting waveform.

## ***FM sound generation***

### **What is FM?**

You probably associate the word "FM" with a type of radio transmission. The "FM" band on your radio and the "FM" of "FM Sound Generation" are the same. They both stand for "**F**requency **M**odulation:". This is the technique of varying the frequency of a sound by the use of another frequency.

Although both the FM of your radio and the FM of FM Sound Generation have the same narrow, technical meaning, the application is quite different.

The audio signals (contents of the broadcast) of an FM broadcast ride on a very high frequency radio **carrier**. The frequency of the carrier is changed slightly by the audio signals. The carrier frequency is the frequency allocated to each station, the same as that which appears on your dial. This frequency is extremely high (millions of Hz) so as to permit the transmission of radio waves through the air and reception with small antennas. The audio signals are in the range audible to the human ear (approx. 20 to 20,000 Hz) and are known as the modulation signal. The difference in frequency between the carrier and audio signal **modulator** (so called because it modulates the frequency of the carrier) is great. Therefore, the carrier frequency changes about 1% at most due to the modulation, and its waveform is not greatly affected.

What happens when the frequency of the carrier is lowered, thus making the frequency of the modulator and carrier closer to one another? In this case, when both carrier and modulator are in the audio frequency range, the carrier waveform will be altered significantly, and a wide range of high and low frequency components will be produced. This is the operating principle used to generate the sound of musical instruments through FM synthesis.

*Fig. 50 Changes in the waveform caused by FM*

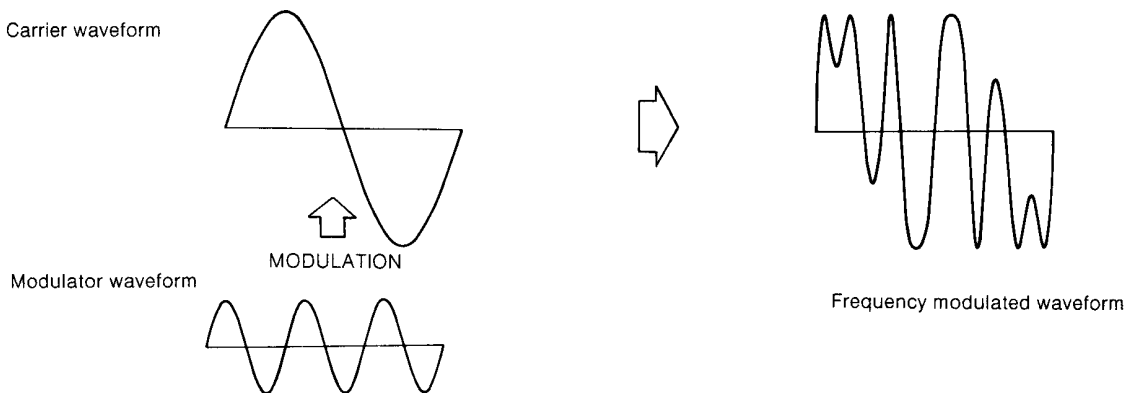

FM Sound Generation allows direct control of the frequency, timbre and volume of sounds. This is a radical departure from analog synthesizers which have been used up to now. Analog synthesizers function by filtering out unwanted harmonics from harmonic-rich waveforms created in the sound-generation section (oscillator) to obtain a desired waveform. FM Sound Generation allows the desired waveform to be created directly by adding and modulating sine waves, allowing a much wider range of possible sounds with more precise control of harmonic structure. Traditional electric organs have used purely additive synthesis, where sine waves had to be supplied for each harmonic, but FM creates additional harmonics through the interaction of sine waves (modulation), and is therefore more efficient. The efficiency of FM makes it possible to synthesize more complex sounds with far less complex circuitry than additive synthesis.

The following BASIC program will display diagrams similar to Fig. 50, giving also the waveform resulting from a pure additive synthesis (two carriers) for comparison. You may vary the amplitude of operator 1 by using the  $\uparrow$  and  $\downarrow$  cursor keys; the  $\leftarrow$  and  $\rightarrow$  cursor key control its frequency. Press the space bar to enter the selected values. To stop this program, press **CTRL** + **STOP**. For each setting, the FM waveform structure is more complex than the structure of the waveform obtained by pure addition. You can also observe that a small change in modulator amplitude causes significant changes in the FM waveform.

```

10 SCREEN 2:COLOR 15,3,7:CLS:OPEN"GRP:"AS1
20 P=ATN(1)/12:F=3:L=20:DIM W(3,1),SW(96):IL=11:GOSUB 130
30 PRESET(32,116):DRAW"C1 R8 BR16 R8 ND16 BR32 R8 U20 L8 R8 D10 R40"
40 GOSUB 140:J0=0:GOSUB 170:J0=1:IL=3
50 IF INKEY$=CHR$(32) THEN RESTORE      :FOR I=1 TO 3:
60 IF INKEY$=CHR$(32) THEN RESTORE 280:GOSUB 130:GOSUB 170
70 S=STICK(0):IF S MOD 2=0 THEN 60 ELSE IF S=1 THEN L=L+2 ELSE IF S=5 THEN L=L-2
80 IF L<0 THEN L=0:BEEP:GOTO 60 ELSE IF L>100 THEN L=100:BEEP:GOTO 60
90 IF S=3 THEN F=F+1 ELSE IF S=7 THEN F=F-.5
100 IF F>.5 THEN F=INT(F)
110 IF F<.5 THEN F=.5:BEEP:GOTO 60 ELSE IF F>10 THEN F=10:BEEP:GOTO 60
120 GOSUB 140:GOTO 60
130 FOR I=1 TO IL:READ X1,Y1,X2,Y2,X3,Y3,C,A$:GOSUB 160:NEXT:RETURN
140 LINE(16,68)-STEP(96,8),9,BF:PSET(17,69)
150 PRINT#1,"F=";RIGHT$(STR$(F),2);" L=";RIGHT$(STR$(L),3);"%":RETURN
160 LINE(X1,Y1)-STEP(X2,Y2),C,BF:PSET(X1+X3,Y1+Y3),C:PRINT#1,A$:RETURN
170 FOR J=J0 TO 3:W(J,0)=0:NEXT:A=L/4:FOR I=2 TO 96 STEP 2:R=I*P
180 FOR J=0 TO 3:ON J+1 GOSUB 190,200,210,220:NEXT J,I:RETURN
190 W(0,1)=25*SIN(B);SW(I)=W(0,1):X=144+I:Y=38.5:GOSUB 230:RETURN
200 W(1,1)=A*SIN(F*B):X=16+I:Y=38.5:GOSUB 230:RETURN
210 W(2,1)=25*SIN(B+W(1,1)/2.5):X=16+I:Y=162.5:GOSUB 230:RETURN
220 W(3,1)=W(1,1)+SW(I):X=144+I:Y=142.5:GOSUB 230:RETURN
230 LINE(X-2,Y-W(J,0))-(X,Y-W(J,1)):W(J,0)=W(J,1):RETURN
240 DATA 16,0,8,8,1,1,6,1,144,0,8,8,1,1,6,2
250 DATA 16,108,16,16,5,5,6,1,40,108,16,16,5,5,6,2
260 DATA 80,88,16,16,5,5,6,1,80,108,16,16,5,5,6,2
270 DATA 144,8,96,60,0,0,4,"",144,68,96,8,1,1,9,"F= 1 L=100%"
280 DATA 16,8,96,60,0,0,4,"",16,132,96,60,0,0,4,"",144,92,96,100,0,0,4,""

```

## FM Sound-Generation System

Instead of an oscillator, something, called an **operator** is used in the actual FM Sound-Generation System. The operator is a digital, computer-like equivalent of a sine wave oscillator, with envelope generator and modulation capability. This operator can be used to create either a carrier or a modulator, as shown below. Each operator receives the instructions (data) for determining the frequency and the output level, then reads the sine wave from the memory according to that input data. An envelope is added to the wave which was read from the memory, and the resultant wave is output. If the output is to be used as an audio signal, this operator is the carrier. If the output is sent to the next operator to control modulation, the operator is a modulator.

Fig. 51 Configuration of operators

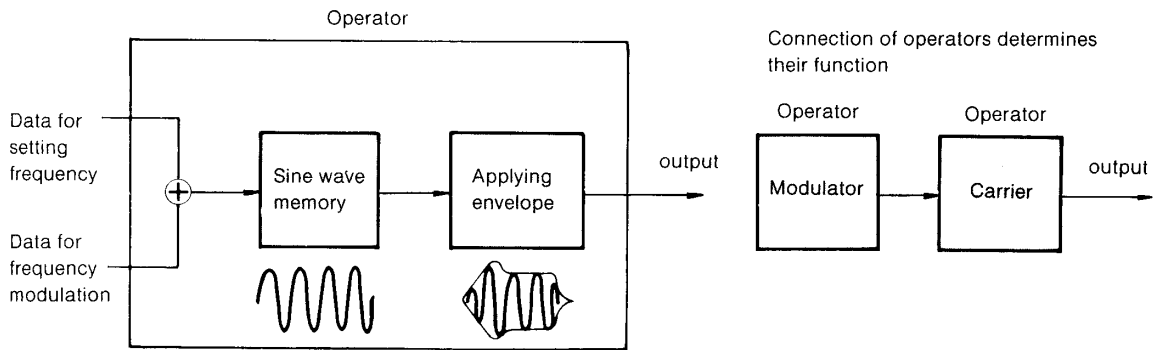

Envelopes are produced by the envelope generator. The envelope controls the change in output level over a period of time for the carrier (which controls the volume), and the change in output level for the modulator over a period of time (which controls the timbre).

The FM Sound Synthesizer unit uses up to four operators to create each sound. Since eight sounds can be generated simultaneously by this unit, there are 32 operators in all.

The way the four operators in a given voice are "connected", and how they function as carriers or modulators, follow specific patterns. These patterns are called **algorithms**. If there is only one carrier and one modulator, a simple FM sound (voice) can be generated. The use of four operators allows for the creation of voices having very complex harmonic structures.

Given four operators, there are large number of possible patterns, but eight of the most useful algorithm patterns have been selected for the FM Sound Synthesizer unit in order to make the creation of sounds more predictable.

Fig. 52 Example of an algorithm

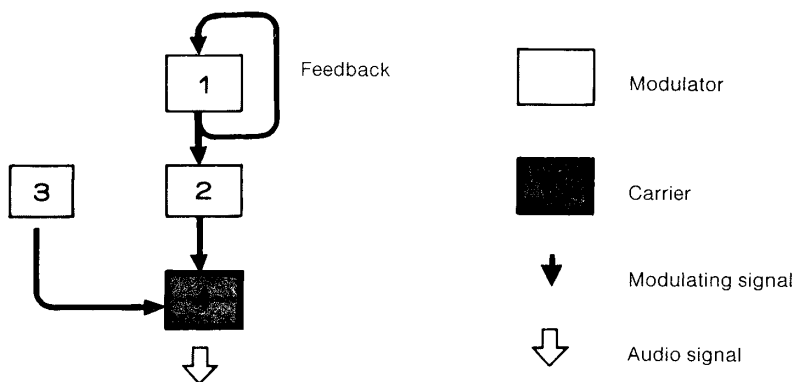

**Feedback** means that a fraction of the signal output by an operator is re-injected in the same operator, resulting in a special auto-modulation. Feedback is used to obtain a large number of harmonics (bright sound) and to create noise.



## Envelope generator

### Envelope generator

The concept of envelopes, which was introduced on page 58, plays an important role in the creation of sounds. The FM Sound Synthesizer unit is equipped with an envelope generator for each operator (EG). The EG of each operator controls the output level of that operator over a period of time. The way that the sound changes over a period of time can be programmed according to the five components of the EG: **attack rate**, **1st decay rate**, **sustain level**, **2nd decay rate**, and **release rate**. These five components have the following functions.

- (1) **Attack rate**: the rate at which the output level of the EG reaches its maximum value when the key is struck.
- (2) **1st Decay rate**: the rate at which the EG level falls from its maximum level to the sustain level setting.
- (3) **Sustain level**: the level sustained after the note moves from 1st decay.
- (4) **2nd decay rate**: the rate at which the EG level falls to zero from the level set as the sustain level.
- (5) **Release time**: the rate at which the EG level falls from the point where the key is released to when it becomes 0.

The period of time the key is hold down is called the **gate time**.

The period of time sound is emitted is called the **note length**.

Fig. 53 The parameters controlled by envelope generator

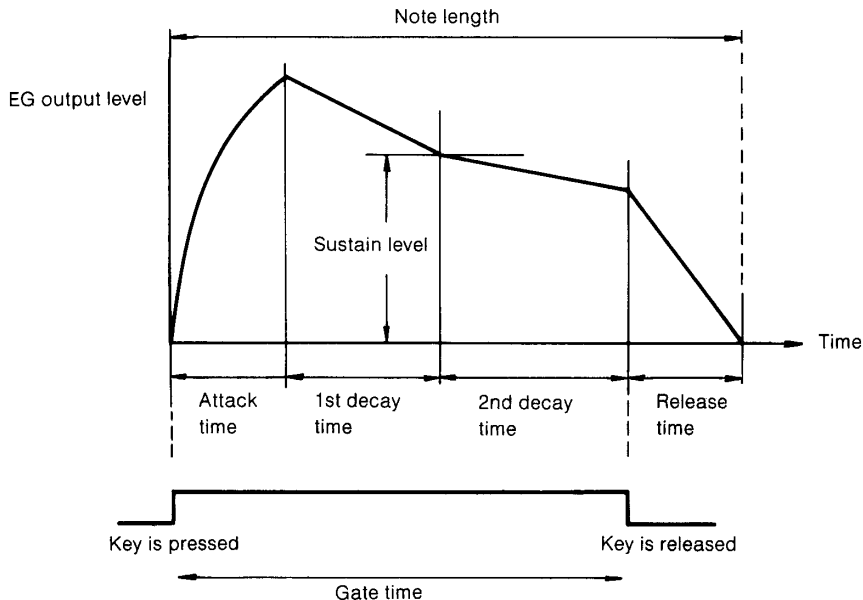

### The relationship between FM Sound Generation and the EG

The Envelope Generators of the FM Sound Synthesizer unit control the operators, which, in turn, determine the changes in volume and timbre over a period of time.

The envelopes for volume and those for harmonics (timbre) are created by using the EG of different operators. Changes in volume are performed by the EGs of the operators which are used as carriers; changes in timbre are performed by the EGs of operators which are used as modulators. Thus, the effect of the EG will change depending on whether the operator is a modulator or a carrier.

Fig. 54 Relationship between FM sound generation and the EG

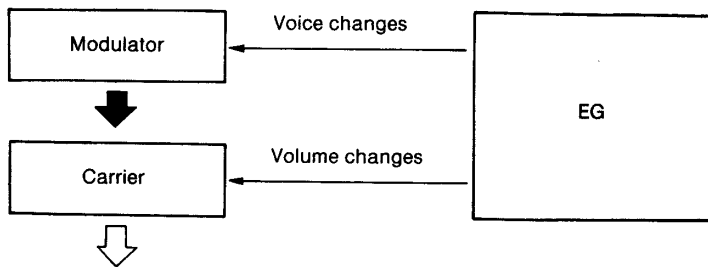

## Key scaling feature

### What is key scaling?

The volume and timbre envelopes of the high and low sections of a piano will differ slightly. This is true not only of the piano but of all acoustic instruments. The FM Sound Synthesizer unit has **key scaling** features which allow the envelope generation to be changed according to the notes played. The key scaling feature allows subtle nuances of the sound to be programmed to change with the position of the keys being played.

### Two types of key scaling

There are two types of key scaling which allow the volume and timbre response to be precisely tailored to the position at which the keys are being played. These two features are **key scaling for EG level** and **key scaling for EG rate**.

- **Level scaling**

Level scaling changes the EG level according to the position of the keys. It can be set independently for each operator, allowing the volume and timbre responses to be adjusted separately.

For example, a setting which will reduce the volume as the higher keys are played or a setting which makes the sound more full-bodied, are both possible.

The level scaling can be adjusted according to two different laws of variation, which are represented in Fig. 55 as two families of curves. One shows the level decreasing as the keys become higher in pitch (straight lines). The other shows the level decreasing as the keys become lower in pitch (curved lines). Both are set by the depth of level scaling.

Fig. 55 Level scaling

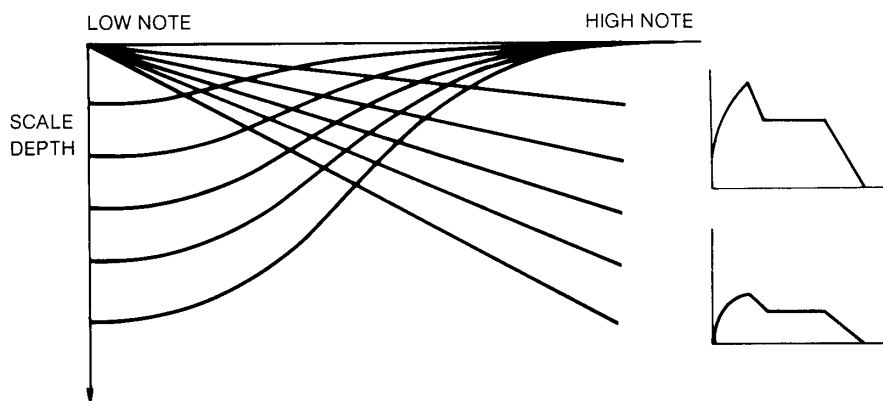

- **Rate scaling**

Rate scaling changes the rates within the envelope according to the position of the keys. This allows a sharp attacking, short decaying envelope to be introduced as the keys become higher. The amount of rate scaling is also determined by the degree of depth determined for each operator.

*Fig. 56 Rate scaling*

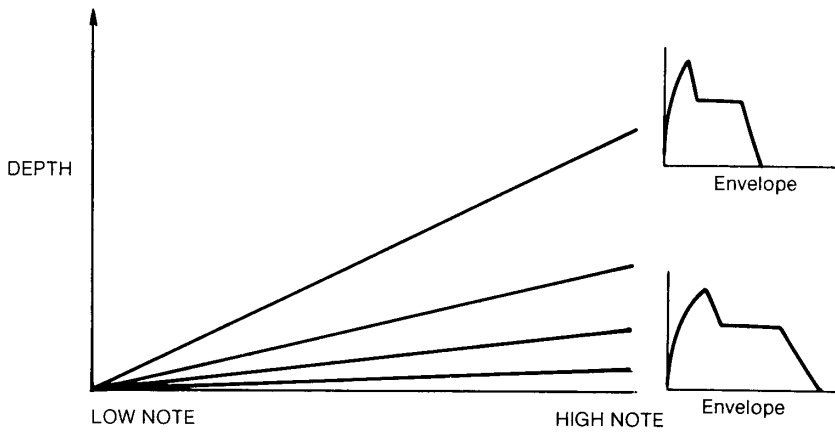

# VOICE DATA PROCESSING

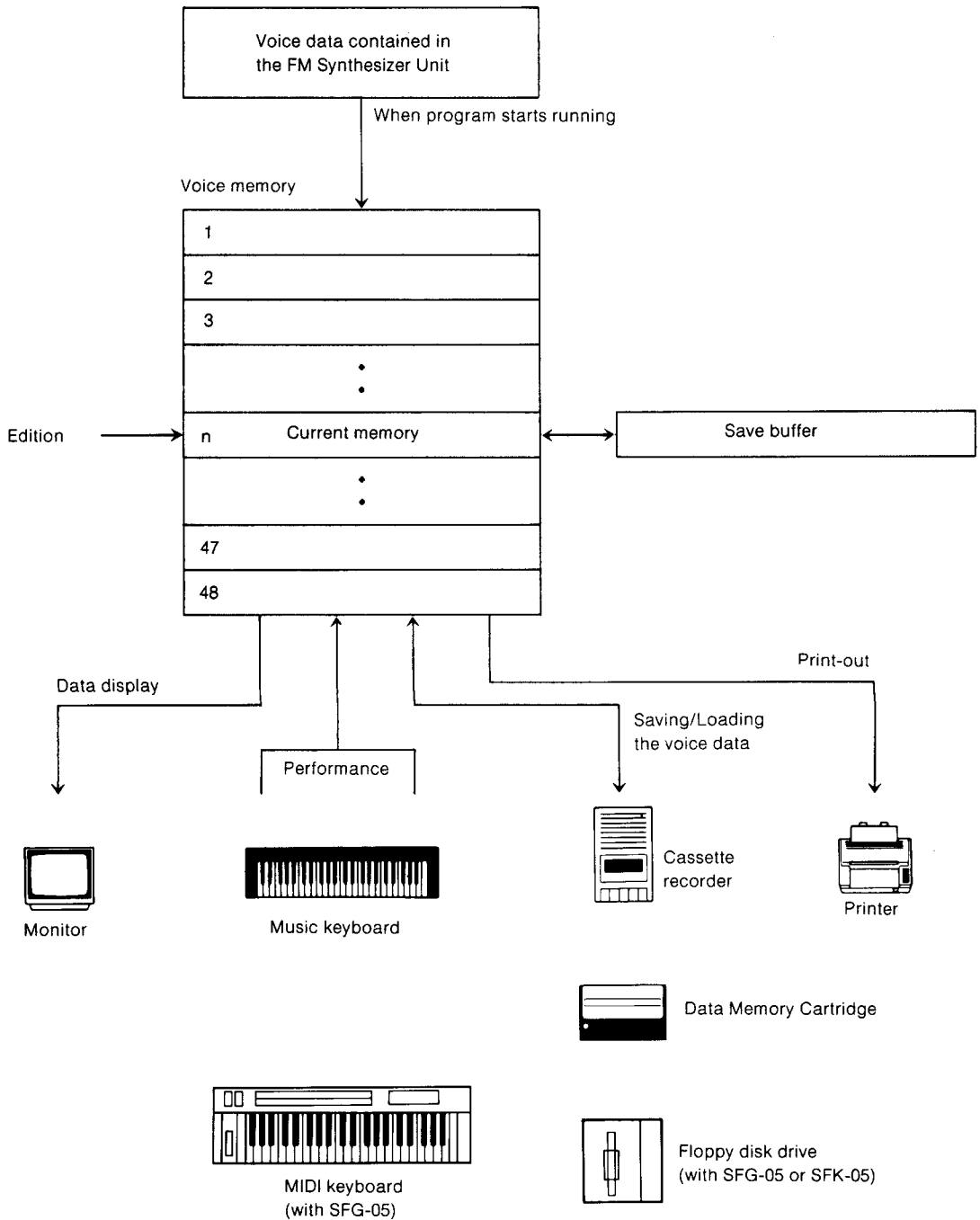

## **ERROR MESSAGES**

The voice number of the voice data stored in the temporary storage buffer (Save Buffer) is usually displayed on the right side of the screen. However, other messages also are displayed in this area when the necessity arises. The meaning of these messages are as follows:

<b>Message</b>	<b>Cause</b>	<b>Remedy</b>
Bad argument	The data following the command is incorrect.	Enter the correct data.
Bad command	The command was not correctly entered.	Enter the correct command.
Read error	An error occurred during the loading of data.	Check connections.
Write error	An error occurred during the saving of data.	Check connections.
Bad name	The file name is not correct.	Designate the correct file name.
Not a voice	The data saved on the floppy disk or Data Memory Cartridge is not a voice data.	Swap the disk or cartridge with one containing voice data.
Not ready	Designated external storage device is not connected.	Connect the device.
Not found	Designated file was not found.	Check the file name and designate the correct file name.
W protect	The floppy disk is write protected.	Remove the write protection.
FD not ready	The floppy disk is not inserted into the disk drive.	Insert the floppy disk properly into the drive.
Disk full	Saving onto full floppy disk was attempted.	Delete unnecessary files, or use a new disk.

# MIDI IMPLEMENTATION CHART

[ FM Voicing Program II ] Date :1985. 3.16  
 Model YRM-52 Implementation Chart Version : 1.0

Function ...	Transmitted	Recognized	Remarks
Basic Default Channel Changed	1ch X	1ch X	
Mode Default Messages Altered	mode 3 (123,126,127) *****	mode 3 X X	
Note Number   True voice	36 - 84 *****	0 - 127 0 - 127	
Velocity Note ON Note OFF	*9n, v=1 - 127 8n, v=64	9n, v=1 - 127 8n, v=0	*fixed
After Touch Key's Ch's	X	X	
Pitch Bender	X	X	
Control Change	X	SUSTAIN (64)	
Prog Change   True #	X *****	X X	
System Exclusive	X	X	
System   Song Pos   Song Sel Common   Tune	X	X	
System   Clock Real Time   Commands	X X	X X	
Aux   Local ON/OFF   ALL Notes OFF	X X	X 123	
Mes-   Active Sense sages   Reset	X X	X X	
Notes			

Mode 1 : OMNI ON, POLY      Mode 2 : OMNI ON, MONO      o : Yes  
 Mode 3 : OMNI OFF, POLY      Mode 4 : OMNI OFF, MONO      x : No

## ALPABETIC INDEX

Algorithm (Al) .....	26, 61
Code .....	37
Detune (Dt) .....	29
Envelop (A, D, S, D, R) .....	30, 50, 62
Envelop generator .....	62, 63
Feedback (Fb) .....	26
Instrument — 1/2 .....	38
Keyboard split point .....	38, 39
Key click .....	15
Key scaling (Ks, Kd, Rk) .....	31, 64, 65
LFO .....	31, 32, 33
LFO enable (LFO) .....	33
LFO Synchronization (Syc) .....	33
Loading .....	23, 24
Noice generator (Ne, Nf) .....	36
Operator frequency (F, IF, Dt) .....	28, 29
Operator level (O, Aj) .....	28
Printing .....	13, 14, 15, 21, 22
Save buffer .....	13, 19, 66
Saving .....	23, 24
Transpose (Tr) .....	36
Tremolo (Wf, Spd, Pmd, Pms) .....	31, 32, 33
Velocity .....	35
Velocity sensitivity (Vs) .....	35
Vibrato (Wf, Spd, Amd, Ams) .....	31, 32, 33



