

Thank you for selecting this YAMAHA NS-C515 speaker system.

## PRECAUTIONS

### Read this before using the speaker.

- To assure the finest performance, please read this manual carefully. Keep it in a safe place for future reference.
- Install the speaker in a cool, dry, clean place – away from windows, heat sources, sources of excessive vibration, dust, moisture and cold. Avoid sources of humming (transformers, motors). To prevent fire or electrical shock, do not expose the speaker to rain or water.
- To prevent the enclosure from warping or discoloring, do not place the speaker where it will be exposed to direct sunlight or excessive humidity.
- Do not place the following objects on the speaker:  
 Glass, china, etc.  
 If glass etc. falls by vibrations and breaks, it may cause personal injury.  
 A burning candle etc.  
 If the candle falls by vibrations, it may cause fire and personal injury.  
 A vessel with water in it  
 If the vessel falls by vibrations and water spills, it may cause damage to the speaker, and/or you may get an electric shock.
- Do not place the speaker where foreign objects such as water drips might fall. It might cause a fire, damage to the speaker, and/or personal injury.
- Do not place the speaker where it is liable to be knocked over or struck by falling objects. Stable placement will also ensure better sound performance.

- Placing the speaker on the same shelf or rack as the turntable can result in feedback.
- Never put a hand or a foreign object into the port located on the rear of the speaker as this might cause personal injury and/or damage to the speaker.
- When moving the speaker, do not hold the port as it might cause personal injury and/or damage to the speaker.
- Any time you note distortion, reduce the volume control on your amplifier to a lower setting. Never allow your amplifier to be driven into “clipping”. Otherwise the speaker may be damaged.
- When using an amplifier with a rated output power higher than the nominal input power of the speaker, care should be taken never to exceed the speaker's maximum input.
- Do not attempt to clean the speaker with chemical solvents as this might damage the finish. Use a clean, dry cloth.
- Do not attempt to modify or fix the speaker. Contact qualified YAMAHA service personnel when any service is needed. The cabinet should never be opened for any reasons.
- **Secure placement or installation is the owner's responsibility.**  
**YAMAHA shall not be liable for any accident caused by improper placement or installation of the speaker.**

## PLACING THE SPEAKER

Place the speaker on TV whose top is flat or on the floor under the TV or inside the TV rack so that it is stabilized. When placing the speaker on top of the TV, to prevent the speaker from falling down, put the provided fasteners at four points on the bottom of the speaker and the top of the TV.

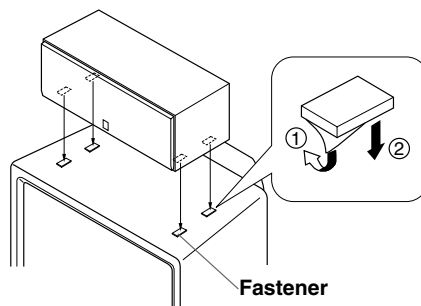
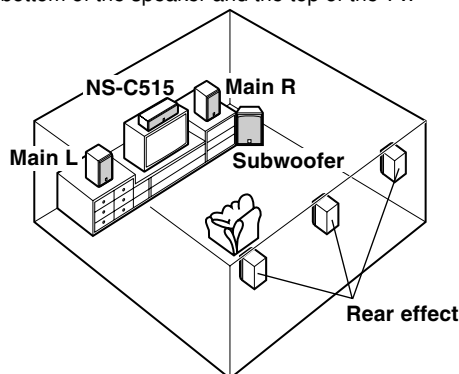

### Notes

- Do not place the speaker on top of the TV whose area is smaller than the bottom area of the speaker. If placed, the speaker may drop out causing an injury to you.
- Do not place the speaker on top of the TV with an inclination.
- Do not touch the adhesive surface after peeling off the seal as this will weaken its adhesive strength.
- Thoroughly wipe clean the surface where the fastener is to be applied. Note that adhesive strength is weakened if the surface is dirty, oily or wet and that this may cause the center speaker to drop.
- This speaker features a magnetically shielded design, but there is still a chance that placing it too close to a TV set might impair picture color. Should this happen, move the speaker away from the TV set.

## CONNECTIONS TO YOUR AMPLIFIER

This speaker system is capable of standard connections and bi-wired connections. Before making connections, make sure that the amplifier is switched off.

### <Standard connections>

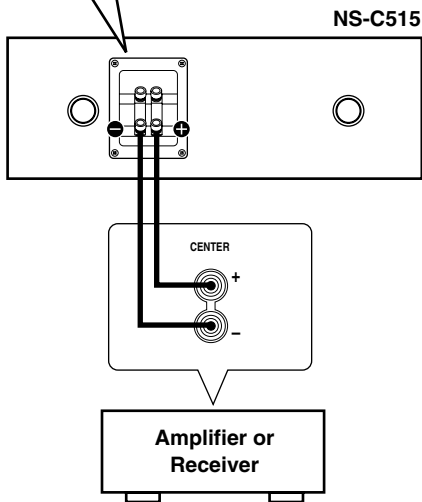
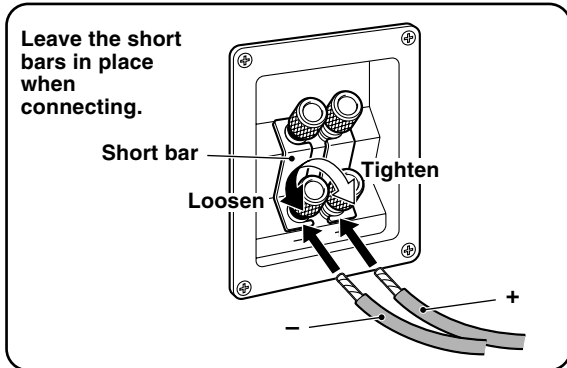

### ■ CONNECTIONS

- Connect the screw-type input terminals at the rear of the speaker to the speaker output terminals of the amplifier (or receiver) with the speaker cable.
- Connect the (+) terminals on the amplifier (or receiver) and the speaker using one side of the cable. Connect the (-) terminals on both components using the other side of the cable.
- Connect the speaker to the center terminals of your amplifier, making sure not to reverse the polarity (+, -). If the speaker is connected with reversed polarity, the sound will be unnatural and lack bass.

#### How to connect:

- ① Loosen the knob.
- ② Remove the insulation coating at the extremity of each speaker cable by twisting the coating off.

**Good**    **No Good**



- ③ Insert the bare wire.
- ④ Tighten the knob and secure the cables. Test the firmness of the connection by pulling lightly on the cables at the terminal.

#### Note

Do not let the bare speaker wires touch each other as this could damage the speaker or the amplifier, or both of them.

### When using a banana plug

<General model only>

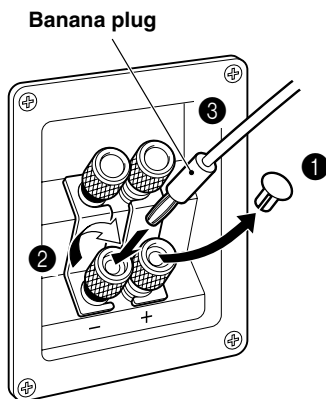

- ① Remove the cover by pulling it toward you.
- ② Tighten the terminal knob.
- ③ Simply insert the banana plug into the terminal.

## REMOVING THE FRONT COVER

The front cover is fastened to the enclosure at four points and can be removed if desired. To remove the cover, hold on to both sides and slowly pull straight away from the speaker. To reattach, line up the four holes on the inner surface of the cover with the four corresponding pegs on the speaker and push gently.

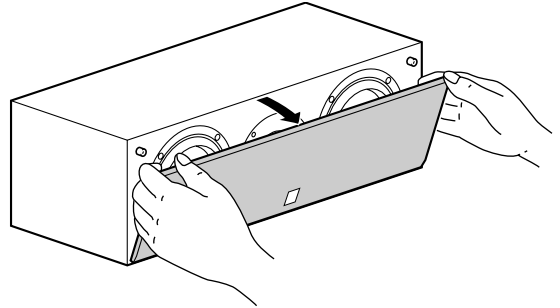

### Note

When the cover is removed, take care not to touch the speaker units with your hands or to exert excessive force with tools.

## SPECIFICATIONS

Type .....	2-way 3-speaker bass reflex speaker system Magnetic shielding type
Driver .....	13 cm (5") cone woofer x 2 3 cm (1") dome tweeter
Impedance .....	6 $\Omega$
Frequency Response .....	57 Hz to 50 kHz
Nominal Input Power .....	100 W
Maximum Input Power .....	300 W
Sensitivity .....	90 dB/2.83 V/m
Crossover Frequency .....	3 kHz
Dimensions (WxHxD) .....	500 x 170 x 218 mm (19-11/16" x 6-11/16" x 8-9/16")
Weight .....	8.0 kg (17 lbs. 10 oz.)
Accessories .....	Fastener x 4

- Specifications subject to change without notice due to product improvements.
- Care should be taken not to exceed the input power values noted above.

## <Bi-wired connections>

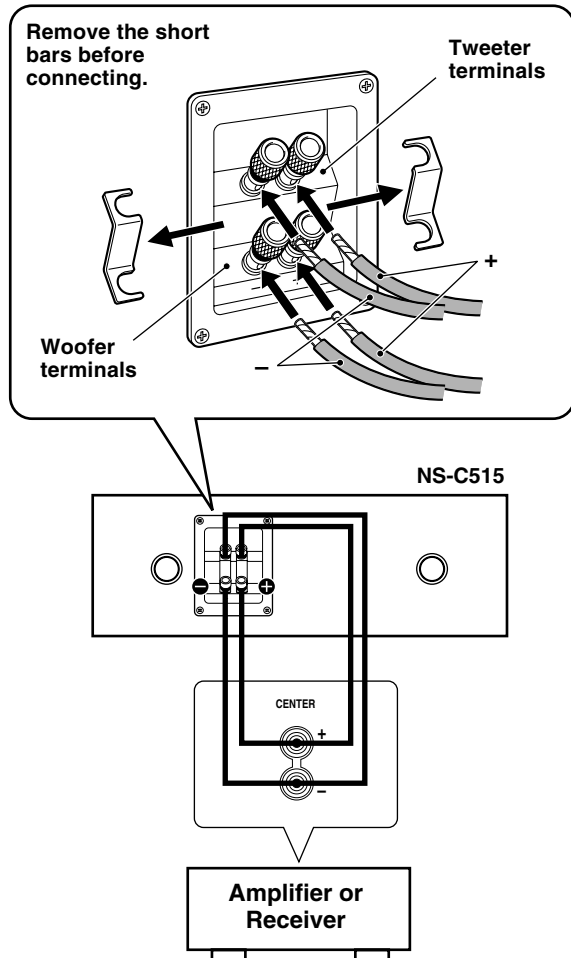

### Bi-Wired Connections

This speaker system is capable of bi-wired connections. To connect the speaker to the output terminals of the amplifier (or receiver), two pairs of cables for each of woofer and tweeter are used instead of standard connections. This type of connection decreases the modulation distortion caused by electric resistance of the cables and driving current of the speakers. Consequently, purer sound quality can be expected.

To utilize bi-wired connections, remove the short bars from the terminals first, and then connect the woofer and tweeter to the amplifier separately using two pairs of cables.