



PERSONAL AMPLIFIER

AP-U70

PERSONAL SOUND PROCESSOR

DP-U50

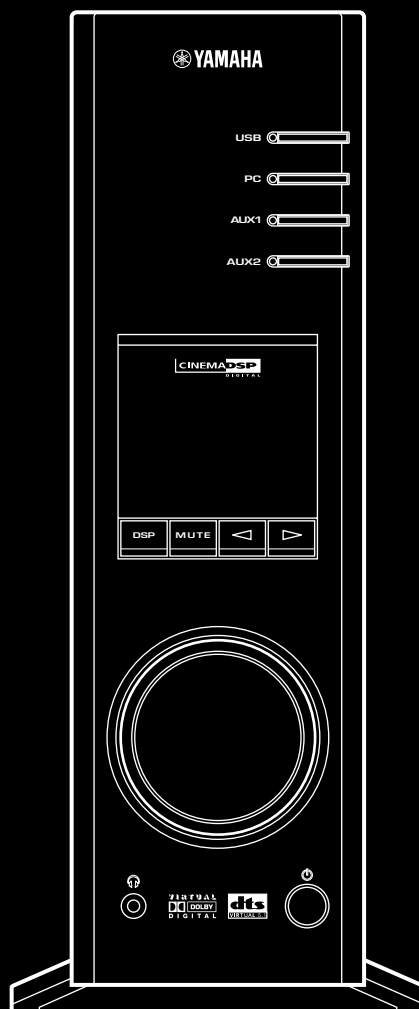

SET UP MANUAL

MANUEL DE CONFIGURATION

The owner's manual for this model consists of two volumes, "**SET UP MANUAL**" and "**OPERATION MANUAL**".

Le manuel d'utilisation pour ce modèle se compose de deux volumes, le "**MANUEL DE CONFIGURATION**" et le "**MANUEL D'UTILISATION**".

- * This manual uses terms utilized by the English operating system as shown on the computer monitor. If the operating system you are using is in another language, please replace the English terms with the terms used in your computer's operating system.
- * Ce manuel utilise des termes employés par les systèmes d'exploitation en langue anglaise tels qu'ils apparaissent sur le moniteur d'un ordinateur. Si votre système d'exploitation utilise une autre langue, veuillez remplacer la terminologie anglaise par celle qu'il utilise.

FEATURES

- This unit brings high-quality audio to your computer.
- The USB interface allows remote control of this unit from your computer, using the supplied Application Software, plus various audio I/O options.
- Ideal for use with computer games, internet music, CD-ROM, DVD, multimedia software, and more.
- Yamaha's Near-Field Cinema DSP (Digital Sound field Processing) technology provides live music performance and movie theater surround sound. The sound effect of DSP is also available for headphone listening.
- Sophisticated Virtual 3D technology reproduces multichannel sources such as Dolby Digital* and DTS** providing a realistic surround effect with just two speakers.
- This unit is compatible with the following audio signals received via a USB connection: multi-channel (two, four and six channels) audio, high quality digital audio of 24 bits/48 kHz and Dolby Digital-encoded signals. (Some operating systems and software programs do not support this feature.)



* Manufactured under license from Dolby Laboratories. "Dolby", "Pro Logic" and the double-D symbol are trademarks of Dolby Laboratories. Confidential Unpublished Works. ©1992–1997 Dolby Laboratories, Inc. All rights reserved.



** Manufactured under license from Digital Theater Systems, Inc. US Pat. No. 5,451,942 and other world-wide patents issued and pending. "DTS", "DTS Digital Surround", are trademarks of Digital Theater Systems, Inc. Copyright 1996 Digital Theater Systems, Inc. All Rights Reserved.

CONTENTS

GETTING STARTED

Unpacking	2
Battery installation	2
Battery replacement	2
Remote control operation range	2

GETTING STARTED

CONNECTIONS

Terminals and their functions	3
Connecting your computer	4
Connecting audio equipment	5
Connecting speakers	6
Plugging in this unit	8

CONNECTIONS

INSTALLING USB DRIVER AND APPLICATION SOFTWARE

Preparations before installation	9
System requirements	9
Installing the software	10
Microsoft Windows 98/98SE	
or Windows Me	10
Microsoft Windows 2000 Professional	13
Macintosh computer	16

INSTALLING USB DRIVER AND APPLICATION SOFTWARE

APPENDIX

Troubleshooting	18
-----------------------	----

APPENDIX

English

GETTING STARTED

Unpacking

After unpacking, check that the following items are supplied.

- Remote control

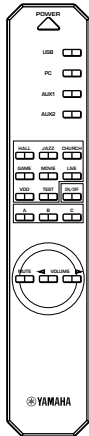

- Batteries (AA, R6, UM-3 type)

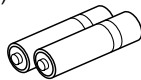

- USB cable

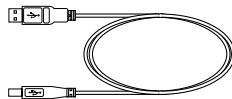

- CD-ROM

The CD-ROM contains the Application Software and online help for controlling this unit from your computer.

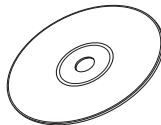

Battery installation

Since the remote control will be used for many of this unit's control operations, you should begin by installing the supplied batteries.

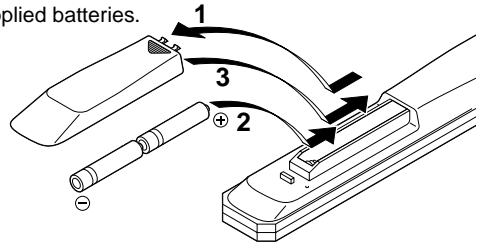

1 Turn the remote control over and remove the battery compartment cover by sliding it in the direction of the arrow.

2 Insert the batteries (AA, R6, UM-3 type) according to the polarity markings on the inside of the battery compartment.

3 Close the battery compartment cover.

Battery replacement

If you notice that the remote control must be used closer to the main unit, the batteries are weak. Replace both batteries with new ones.

Notes

- Use AA, R6, UM-3 batteries.
- Be sure the polarities are correct. (See the illustration inside the battery compartment.)
- Remove the batteries if the remote control is not to be used for an extended period of time.
- If the batteries leak, dispose of them immediately. Avoid touching the leaked material and avoid contact with clothing, etc. Clean the battery compartment thoroughly before installing new batteries.

Remote control operation range

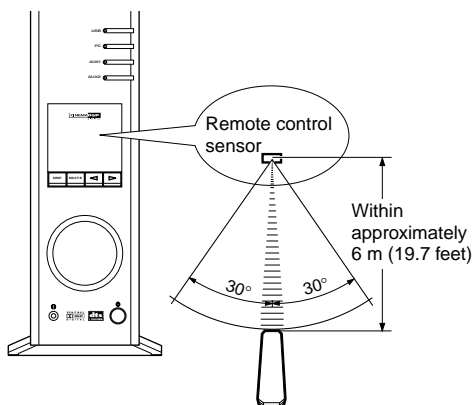

Notes

- The area between the remote control and the main unit must be clear of large obstacles.
- Do not expose the remote control sensor to strong lighting, in particular, an inverter type fluorescent lamp; otherwise, the remote control may not work properly. If necessary, position the main unit away from direct lighting.

CONNECTIONS

Never plug in this unit and other equipment until all connections are completed.





1. Make connections between this unit and other components by following the procedure below.
2. After all connections are finished, check that the connection cords are correctly connected.
3. After all connections are completed, plug in this unit and other equipment.

Note

Also, refer to the owner's manual for other equipment in the system.

Use commercially available connection cords (except the supplied USB cable).

The color of this unit's inputs/outputs and connection cords to be used for connecting to them are as follows:

White	Audio connection cord (analog/stereo), left	
Red	Audio connection cord (analog/stereo), right	
Black	Audio connection cord (analog/monaural)	
Orange	Coaxial digital connection cord	

Terminals and their functions

1 ANALOG inputs

These connectors are used to connect to the analog outputs of a PC sound card, CD player, MD recorder, tape deck, etc.

2 SUBWOOFER OUTPUT

This connector can be connected to an optional subwoofer, such as the Yamaha YST-SW45, for enhanced bass performance.

3 SPEAKERS outputs [AP-U70 only]

These connectors are used to connect a pair of speakers, such as the Yamaha NS-U30.

4 REC OUT [AP-U70 only]

These connectors are used to connect to the analog inputs of an MD recorder or tape deck.

4 PRE OUT [DP-U50 only]

These connectors are used to connect to the analog inputs (INPUT etc.) of speakers incorporated with an amplifier, or a power amplifier. The level of signals outputted from the PRE OUT varies by the use of the volume control on the front panel or the **VOLUME** keys on the remote control.

5 PC inputs & output (DIGITAL)

USB: If your computer has a USB port, connect it to this unit, using the supplied USB cable, for remote control of this unit from your computer.

PC COAX IN/OPT IN: These coaxial and optical connectors are used to connect to the digital outputs of a PC sound card, DVD-Video decoder board, etc.

6 Optical input & output (DIGITAL)

AUX 1 OPT IN: This connector is used to connect to an optical output of a CD player, MD recorder, etc.

OPT OUT: This connector is used to connect to an optical input of an MD recorder, a DAT deck, etc.

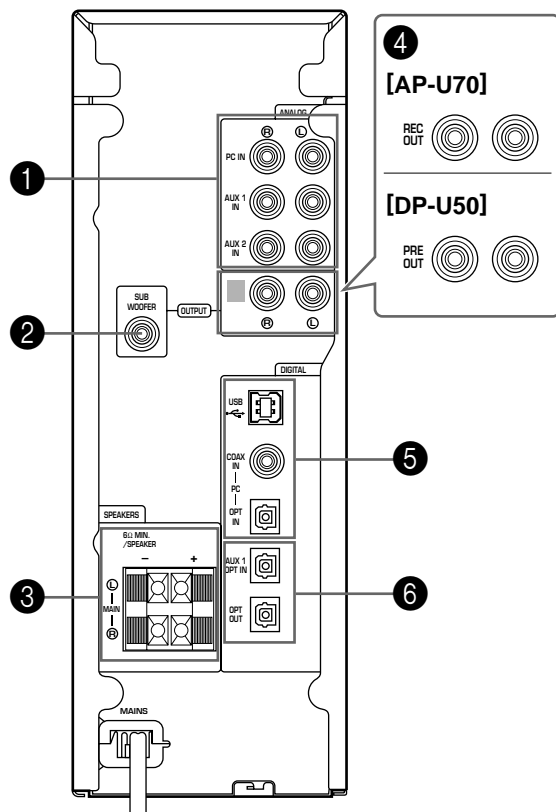

Connecting your computer

Audio from your computer can be fed to this unit using any of the following connectors: USB, DIGITAL PC COAX IN, DIGITAL PC OPT IN, or ANALOG PC IN. If you use all of these connectors for connection, you can select the connector(s) to use on this unit's front panel or the remote control.

Connecting to the USB port (1)

If your computer has a USB port, connect it to this unit's USB terminal using the supplied USB cable, as shown below.

A single USB connection is all that's required to listen to audio from your computer on this unit, feed audio from an external source connected to this unit to your computer, and control this unit remotely from your computer, using the supplied Application Software.

If your computer doesn't have a USB port, you can still connect it to this unit using the analog or digital input, but in this case you cannot use this unit's Application Software.

Note

Connect the USB cable when installing the USB driver software on your computer. Refer to the section "INSTALLING USB DRIVER AND APPLICATION SOFTWARE".

Connecting to analog inputs (2)

Connect the analog audio outputs on your computer or a PC sound card to this unit's ANALOG PC IN.

Use a commercially available pin-plug connection cord for connection, and be careful not to mix up the left and right connections.

Connecting to digital inputs (3)

To play DVD-Video discs encoded with Dolby Digital or DTS, your computer must have a DVD-ROM drive and DVD-Video decoder board, which should be connected to this unit via the DIGITAL PC COAX IN or DIGITAL PC OPT IN.

Use a commercially available pin-plug cord for connecting to the DIGITAL PC COAX IN, and use a commercially available optical fiber cable for connecting to the DIGITAL PC OPT IN.

Note

The DIGITAL PC OPT IN has priority over the DIGITAL PC COAX IN, so if you connect to both inputs, the signal received at the DIGITAL PC OPT IN is used.

Protective Caps

When connecting to an optical connector, remove its protective cap first. When an optical connector is not being used, replace its cap to prevent dust entering the connector.

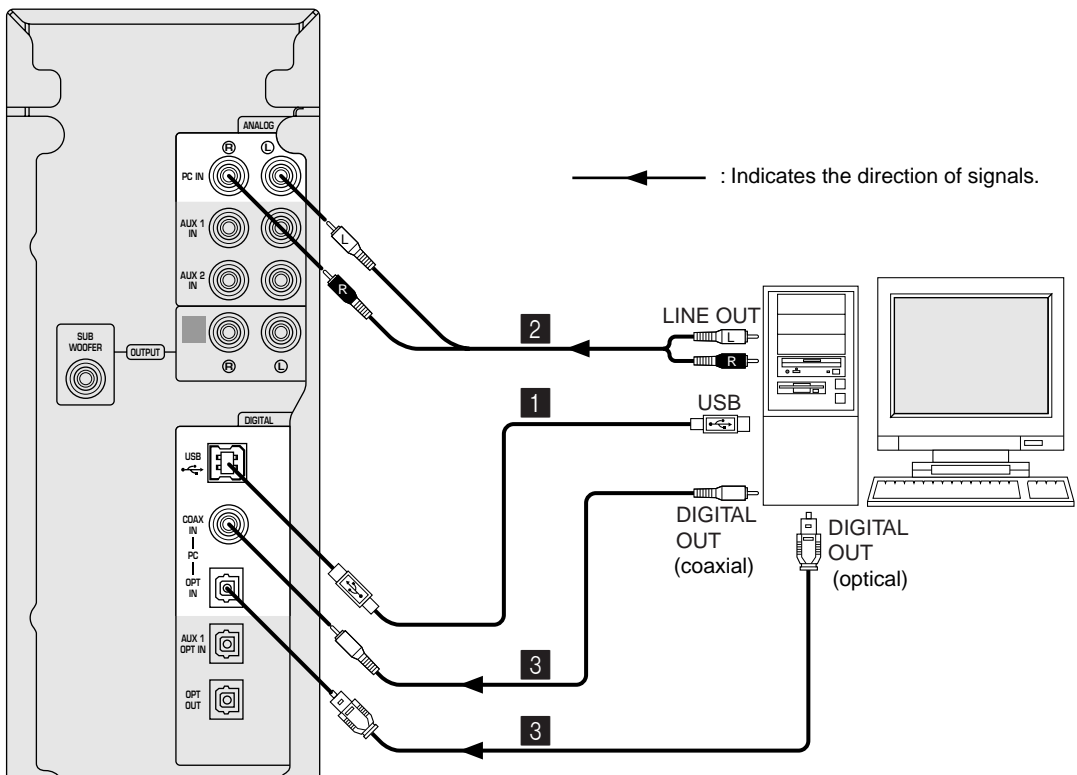
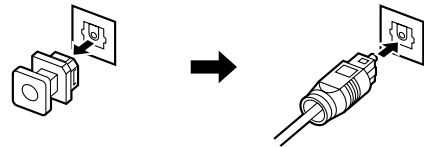

Connecting audio equipment

The following illustrations show how to connect a CD player, MD recorder, etc. using both analog and digital connections. However, it's not necessary to make both connections.

Audio connections

- Be careful not to mix up the left and right connections.

[AP-U70 only]

If you wish to record analog sound signals inputted to this unit, connect the analog inputs of a tape deck or MD recorder to this unit's REC OUT OUTPUT.

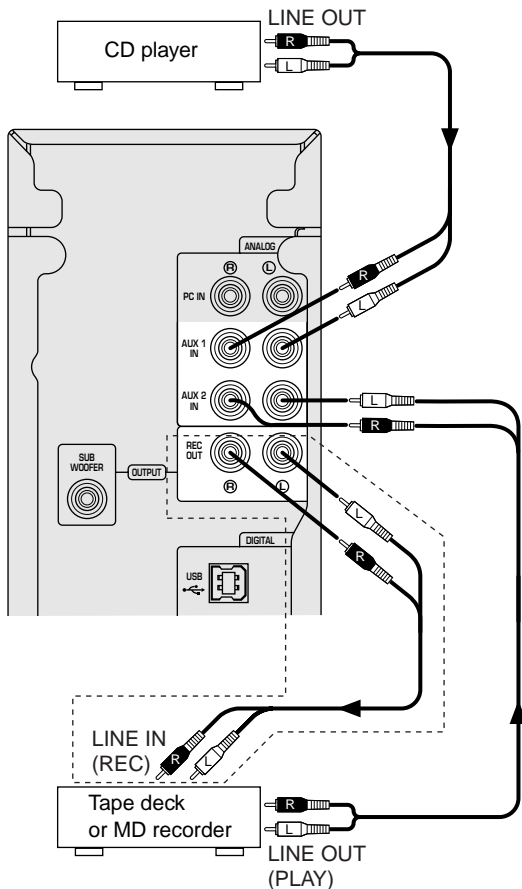

[] : [AP-U70 only]

Notes

- **Connecting a turntable**
A turntable cannot be connected to this unit directly. Use a commercially available phono equalizer amplifier to connect a turntable to this unit, or connect a turntable incorporated with a phono equalizer amplifier.

[AP-U70 only]

The REC OUT OUTPUT and DIGITAL OPT OUT can be used at the same time since they output signals independently.

Digital connections

If you wish to record digital sound signals inputted to this unit, connect the optical digital input of an MD recorder or a DAT deck to this unit's DIGITAL OPT OUT.

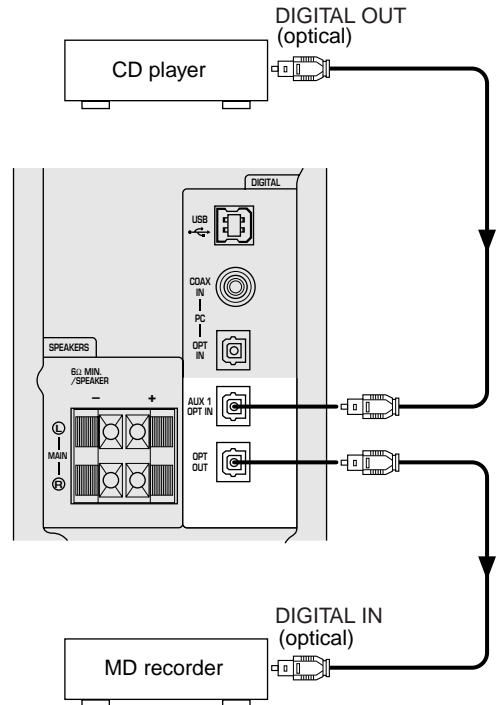

Notes

- When playing an ordinary CD on this unit following playback of a CD or an LD encoded with DTS, some operations, such as resetting the input selector keys, may be required.
- Even if connected to this unit with a digital connection, some CD, LD, and DVD players may make this unit fail to decode DTS or produce noise. This is because certain digital output data processing by such a player results in DTS-encoded data errors that cause playback failure although the same data processing may cause only a slight change in volume or in frequency response in normal digital sound.
- When an error occurs in the player's digital output data during playback of an LD or CD encoded with DTS, playback may be disrupted. If this occurs, stop playback and repower the player.
- When digital sound signals from the computer are played, errors in WAVE signals, etc. may occur resulting in noise or a playback failure.

Connecting speakers

[AP-U70 only]

Connect this unit to your speakers with speaker cables with a proper gauge (keep them as short as possible).

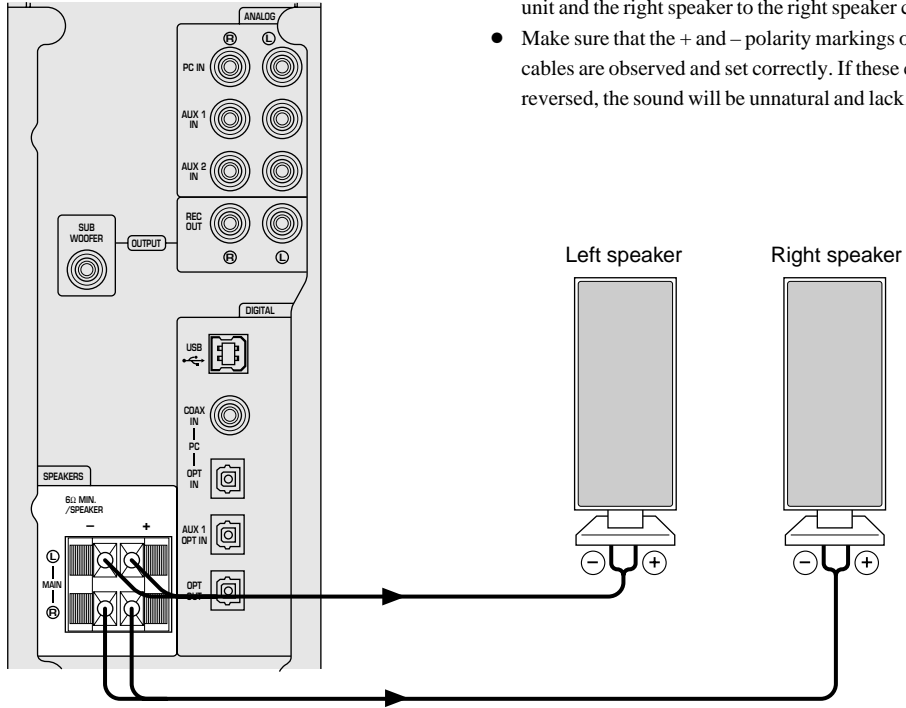

Notes

- Use speakers which do not have a built-in amplifier.
- Use speakers whose impedance is 6Ω or more.
- Connect the left speaker to the left speaker connector on this unit and the right speaker to the right speaker connector.
- Make sure that the + and – polarity markings of the speaker cables are observed and set correctly. If these cables are reversed, the sound will be unnatural and lack bass.

Speaker Cables

Strip 10 mm of insulation off the end of each speaker cable, and then twist the bare wires to prevent loose strands, which can cause short circuits.

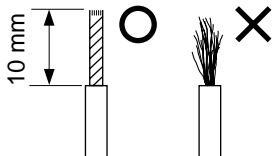

How to connect:

- ① Press and hold the speaker connector levers.
 - ② Insert the bare ends of the speaker cables into the terminal holes.
 - ③ Then release the levers.
- * Try pulling gently on each cable to make sure that it is secure.

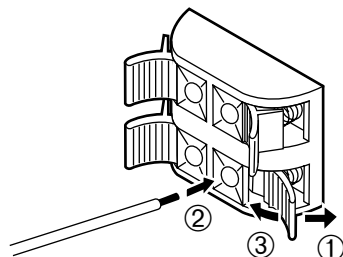

[DP-U50 only]

To reproduce sound signals inputted to this unit over speakers, connect this unit to speakers with a built-in amplifier, a mini-component system, etc., or connect this unit to speakers by using an external power amplifier. Connect the analog inputs of speakers with a built-in amplifier, etc. to this unit's PRE OUT using a commercially available analog pin-plug cord or a pin (stereo)-to-mini (stereo) plug cord.

Note

The level of signals outputted from the PRE OUT varies by the use of the volume control on the front panel or the **VOLUME** keys on the remote control. So, it is recommended to adjust the speaker output level on this unit or the remote control, and fix the volume of speakers with a built-in amplifier, etc. at a certain level.

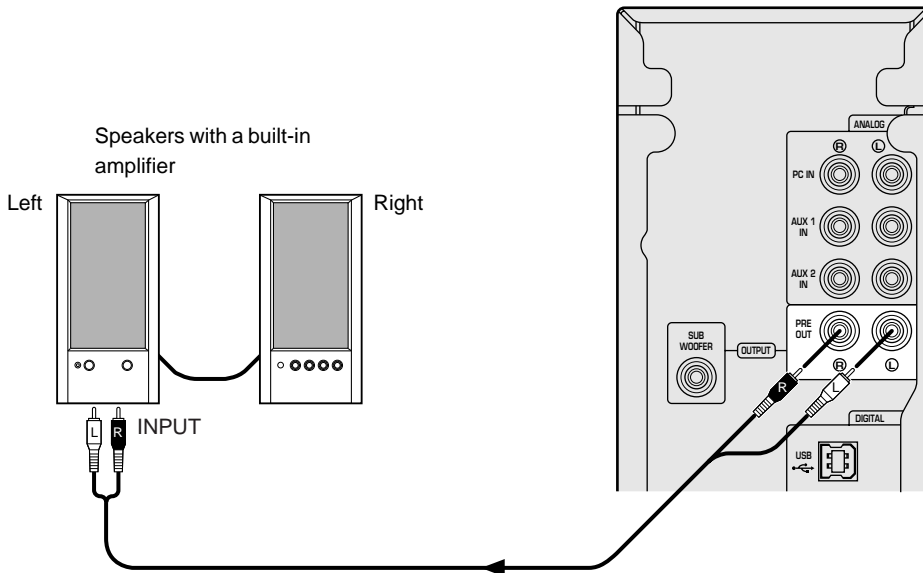

Adding a subwoofer

Bass performance can be extended by connecting a subwoofer to this unit's SUBWOOFER OUTPUT using a commercially available audio pin-plug cord. The use of a subwoofer is also suitable for reproducing the effects of sound field programs.

Note

The SUBWOOFER OUTPUT is a line-level output. Use a subwoofer which has its own built-in power amplifier, such as the Yamaha YST-SW45.

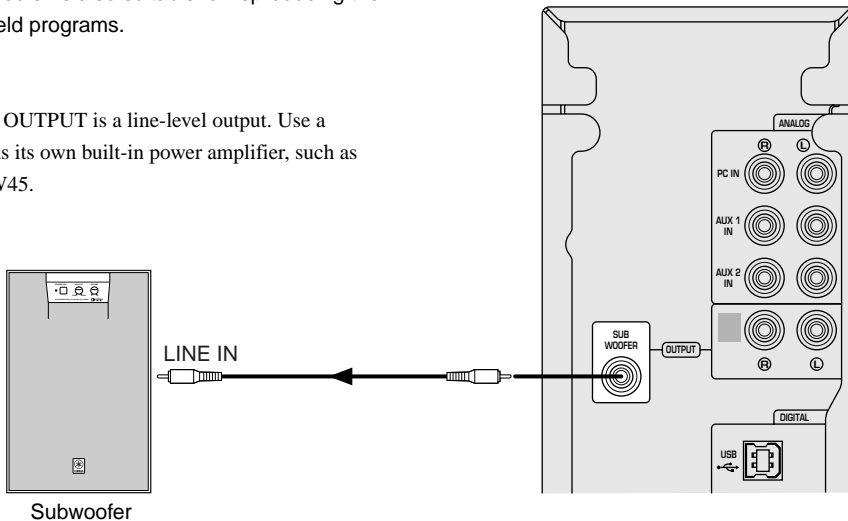

Recommended Speaker Placement

For best performance, place the left and right speakers on either side of your computer monitor, as shown below, and position them so that their fronts are flush with the monitor screen. To get the best from the sound field programs and surround effects, the left and right speakers and the listener should be positioned so as to form a triangle with a 3:4 ratio, so if, for example, the speakers are 60 cm (23.5") apart, the listener should be 80 cm (31.5") away from each speaker.

If your system includes a subwoofer (YST-SW45, etc.), place it on the floor.

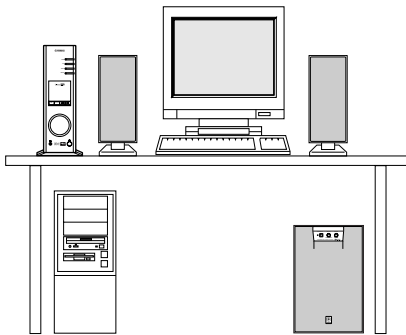

Recommended listening position

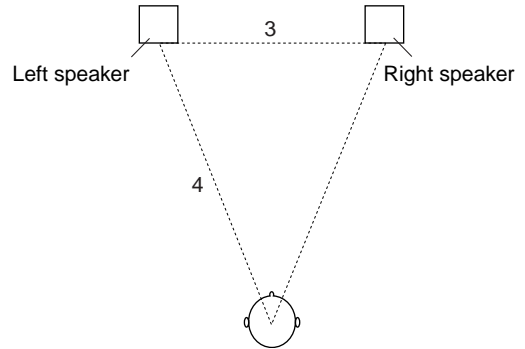

Note

Use magnetically shielded speakers and subwoofer. Using non-magnetically shielded speakers near the computer monitor may impair picture color or damage the monitor.

Plugging in this unit

After completing all connections, plug the AC power cord into a household AC outlet.

Note

Unplug the AC power cord from the AC outlet if this unit is not to be used for a long period of time.

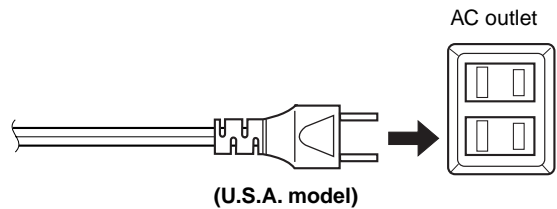

INSTALLING USB DRIVER AND APPLICATION SOFTWARE

When connecting this unit and your computer with the USB cable and controlling this unit from the computer, you must install the following software on your computer.

- ◆ **USB driver software:** Necessary for this unit to communicate with your computer Use the software originally supplied with the OS (Operating System) running on your computer
- ◆ **Application Software:** Used to control this unit from a computer Download from the supplied CD-ROM
- ◆ **Online help :** Instructions for using the Application Access from the supplied CD-ROM

This section explains how to install the software. The installation method differs from the OS running on your computer. Refer to the instructions suitable for your OS below.

Preparations before installation

- **Make sure that the USB cable is not connected to this unit and that your computer is not activated.**
- Make sure that your computer meets the **system requirements** listed below.
If your computer does not meet the system requirements, you can use the computer as an input source by connecting it to the analog or digital input(s) of this unit. In that case, however, the supplied Application Software cannot be used.
- You may be requested to insert your OS's CD-ROM during the installation, so please have it ready before commencing.
- The installing method may differ from the instructions below depending on the operating environment of your computer. In such a case, follow the instructions shown on the monitor. If you still have any question, inquire at the manufacturer of your computer or a computer dealer.

System requirements

Your computer must meet the following system requirements to use the supplied Application Software.

Microsoft Windows 98/98SE, Windows Me or Windows 2000 Professional

Operating System

Microsoft Windows 98/98SE, Windows Me or Windows 2000 Professional

Computer

A computer with a USB port as a standard equipment and preinstalled with the above OS.

Windows is a registered trademark of Microsoft Corporation in the United States and/or other countries.

Macintosh

Operating System

Mac OS 9.0.4 or greater (USB Driver 1.4 or greater)

Computer

Macintosh computer with a USB port as a standard equipment

Macintosh is a trademark of Apple Computer, Inc., registered in the U.S. and other countries.

Installing the software

Microsoft Windows 98/98SE or Windows Me

■ Installing and checking the USB driver

1 Turn on your computer and, if it's not running already, start Windows 98/98SE or Windows Me.

2 Plug the AC power cord of this unit into the AC outlet.

This unit can be on or in standby mode when installing the driver.

3 Connect this unit to a USB port on the computer using the supplied USB cable.

Windows automatically detects this unit and installs the necessary driver software. Make operations as indicated in the dialog box. You may be requested to insert your Windows OS CD-ROM.

* The installation may take a longer time depending on the system environment. After the installation dialog box disappears, wait several minutes.

Check that the USB driver has been installed successfully by following the procedure below.

4 Click the Windows "Start" button and select "Settings", and then "Control Panel".

The Control Panel window appears.

5 Double-click the "System" icon.

The System Properties window appears.

6 Click the "Device Manager" tab.

The Device Manager window appears.

7 Click the "View devices by type" option button.

8 Click the "+" symbol next to "Sound, video and game controllers," and make sure that "USB Audio Device" appears in the list, as shown.



* The screen image is for Windows 98SE.

* When using Windows Me, "?" may be shown at the head of "USB Composite Device" in green. This means the USB driver has been installed with the Generic ID supplied with the operating system. (This is not an error message.)

9 Click the "+" symbol next to "Human Interface Devices", and make sure that "HID-compliant consumer control device" and "USB Human Interface Device" appear in the list, as shown.

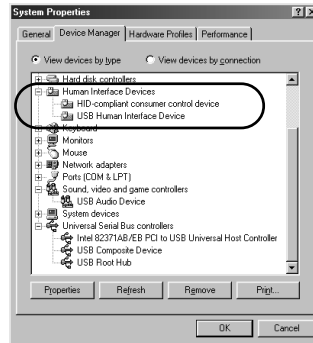

* The screen image is for Windows 98SE.

10 Click the "+" symbol next to "Universal Serial Bus controllers" and make sure that "USB Composite Device" appears in the list, as shown.

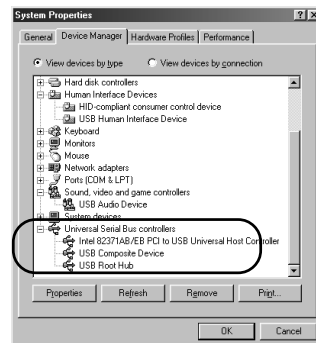

* The screen image is for Windows 98SE.

Notes

- The device list on your computer may differ to that shown here.
- If "!" or "?" is shown at the head of the device name, check the followings:
 - * The USB cable is firmly connected.
 - * The AC power cord of this unit is plugged into an AC outlet.
- If the driver has not been successfully installed, disconnect the USB cable and connect it again. Then try to install the driver again. If installation still fails, restart Windows and try again.

Make the following settings on your computer after the installation of the driver is finished.

**Setting of Audio and Audio CD
[Windows 98/98SE only]**

- * Terminate all the activated applications.
- * When using Windows 98SE, restart Windows, first.

1 Click the Windows “Start” button and select “Settings”, and then “Control Panel”.

2 Double-click the “Multimedia” icon.

3 Click the “Audio” tab and select “USB Audio Device” at “Preferred device” of “Playback”.

- * Usually, this setting is automatically made.
- * If “USB Audio Device” does not appear, restart Windows.

4 Click the “CD Music” tab and select the CD-ROM drive for playing audio CDs.

5 Click the check box of “Enable digital CD audio for this CD-ROM device” to enter the check mark.

- * It may happen that the check box cannot be clicked because some CD-ROM drives cannot be used for playing audio CDs.

6 Click “OK” and close the “Multimedia” setting panel.

7 Restart Windows.

Note

When using two or more drives, you must make the above setting for each drive.

**Checking the Audio setting
[Windows Me only]**

1 Click the Windows Me “Start” button and select “Settings”, and then “Control Panel”.

2 Double-click the “Sounds and Multimedia” icon.

3 Click the “Audio” tab and select “USB Audio Device” at “Preferred device” of “Sound Playback”.

- * Usually, this setting is automatically made.
- * If “USB Audio Device” does not appear, restart Windows.

**Checking sound output and adjusting volume
[Windows 98/98SE and Windows Me]**

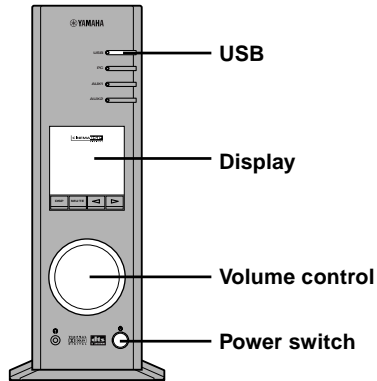

1 Make the following operations on the front panel of this unit.

- a) Press the power switch to turn on this unit. (Some messages are shown on the display.)
- b) Press the USB input selector key.
- c) Use the volume control to adjust the volume. (Set the control to about “30”.)

2 Adjust the volume on the computer as follows.

- a) Double-click the speaker icon on the task tray, or select “Start”, “Programs”, “Accessories”, “Entertainment” in this order and click “Volume Control”. (The volume adjustment window appears.)
- b) Adjust the volume by dragging the “Volume” slider. Set the slider between the center and max. positions.

- * Do not enter the check mark in the “Mute” check box. If entered, sound output will stop.

3 Click the Windows “Start” button and select “Settings”, and then “Control Panel”.

4 Double-click the “Sounds” (or “Sounds and Multimedia”) icon.

5 Click the “Sounds” tab.

6 Check that the sound is output normally by outputting “Default sound”, etc. from “Events” (or “Sound Events”).

- * If no sound is heard, restart Windows and check again.

Next, install the Application Software and Online Help from the supplied CD-ROM.

■ Installing the Application Software

* Terminate all the activated applications (including virus checkers) on the computer first.

1 Insert the CD-ROM into the CD-ROM or DVD-ROM drive.

If the Windows Autorun feature is turned on, the installation start-up screen appears automatically.

2 Continue with the installation as prompted.

If the Windows Autorun feature is not turned on

Display the contents of the CD-ROM by using "My Computer" etc., and double-click on "Readme.txt". The installation method is described in this file.

■ Using the Application Software and Online Help

This section explains how to start the Application Software and view the online help.

1 Click the Windows "Start" button and select "Programs", "YAMAHA AP-U70 (or DP-U50)", "AP-U70 (or DP-U50)" in this order.

The Application Software starts.

2 To view the online help, click the Windows "Start" button and select "Programs", "YAMAHA AP-U70 (or DP-U50)", "Help" in this order.

The online help, which explains how to use the Application Software, starts.

Note

Never disconnect the USB cable while starting up the Application Software. If disconnected, the computer may hang.

■ Uninstalling the Application Software

This section explains how to uninstall the Application Software.

1 Terminate the Application Software and online help.

2 Click the Windows "Start" button and select "Settings", and then "Control Panel".

The Control Panel window appears.

3 Double-click the "Add/Remove Programs" icon.

The "Add/Remove Programs Properties" window appears.

4 Select "YAMAHA AP-U70 (or DP-U50) Application" in the software list.

"YAMAHA AP-U70 (or DP-U50) Application" is highlighted.

5 Click the "Add/Remove Programs" button and continue as prompted.

Microsoft Windows 2000 Professional

■ Installing and checking the USB driver

1 Turn on your computer and, if it's not running already, start Windows 2000 Professional, and log in with Administrator.

2 Plug the AC power cord of this unit into the AC outlet.

This unit can be on or in the standby mode when installing the driver.

3 Connect this unit to a USB port on the computer using the supplied USB cable.

Windows automatically detects this unit and installs the necessary driver software.

* The installation may take a longer time depending on the system environment. After the dialog box for installation disappears, wait several minutes.

Check that the USB driver has been installed successfully by following the procedure below.

4 Click the Windows "Start" button and select "Settings", and then "Control Panel".

The Control Panel window appears.

5 Double-click the "System" icon.

The System Properties window appears.

6 Select the "Hardware" tab, and click the "Device Manager".

The Device Manager window appears.

7 Select the "View" tab, and click the "Devices by type" option button.

8 Click the "+" symbol next to "Sound, video and game controllers," and make sure that "USB Audio Device" appears in the list, as shown.

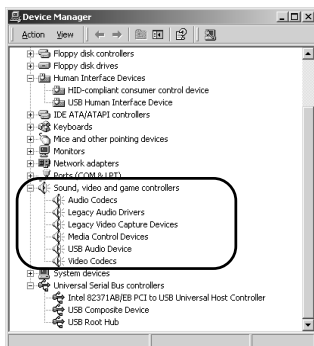

9 Click the "+" symbol next to "Human Interface Devices", and make sure that "HID-compliant consumer control device" and "USB Human Interface Device" appear in the list, as shown.

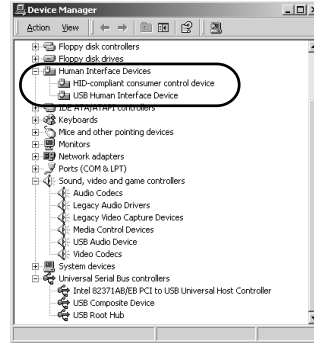

10 Click the "+" symbol next to "Universal Serial Bus controllers" and make sure that "USB Composite Device" appears in the list, as shown.

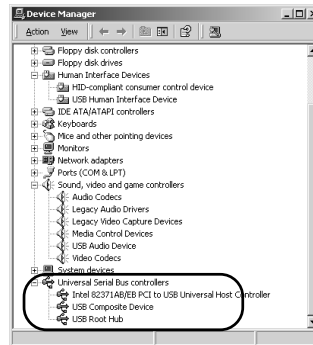

Notes

- The device list on your computer may differ to that shown here.
- If "!" or "?" is shown at the head of the device name, check the followings:
 - * The USB cable is firmly connected.
 - * The AC power cord of this unit is plugged into an AC outlet.
- If the driver has not been successfully installed, disconnect the USB cable and connect it again. Then try to install the driver again. If installation still fails, restart Windows and try again.

Make the following settings on your computer after the installation of the driver is finished.

Setting of Audio and Audio CD

- 1** Click the Windows “Start” button and select “Settings”, and then “Control Panel”.

- 2** Double-click the “Sounds and Multimedia” icon.

- 3** Click the “Audio” tab and select “USB Audio Device” at “Preferred device” of “Sound Playback”.
 * Usually, this setting is automatically made.

- 4** Click the “Hardware” tab and double-click the item of the DVD or CD-ROM to be used in the “Devices”.

- 5** Click the “Properties” tab, and click the check box of “Enable digital CD audio for this CD-ROM device” to enter the check mark.
 * It may happen that the check box cannot be clicked because some CD-ROM drives cannot be used for playing audio CDs.

- 6** Restart Windows, and log in with Administrator.

Note

When using two or more drives, you must make the above setting for each drive.

Checking sound output and adjusting volume

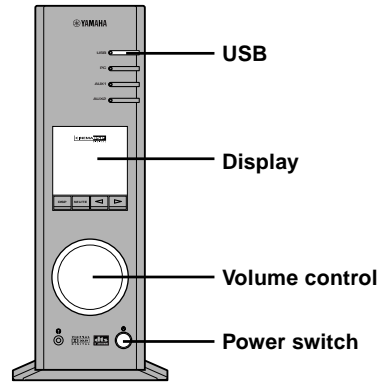

- 1** Make the following operations on the front panel of this unit.
 - a) Press the power switch to turn on this unit. (Some messages are shown on the display.)
 - b) Press the USB input selector key.
 - c) Use the volume control to adjust the volume. (Set the control to about “30”.)

- 2** Adjust the volume on the computer as follows.
 - a) Double-click the speaker icon on the task tray, or select “Start”, “Programs”, “Accessories”, “Entertainment” in this order and click “Volume Control”. (The volume adjustment window appears.)
 - b) Adjust the volume by dragging the “Volume” slider. Set the slider between the center and max. position.
 * Do not enter the check mark in the “Mute” check box. If entered, sound output will stop.

- 3** Click the Windows “Start” button and select “Settings”, and then “Control Panel”.

- 4** Double-click the “Sounds and Multimedia” icon.

- 5** Click the “Sounds” tab.

- 6** Check that the sound is output normally by outputting “Default Beep”, etc. from “Sound Events”.

* If no sound is heard, restart Windows and check again.

Next, install the Application Software and Online Help from the supplied CD-ROM.

■ Installing the Application Software

1 Insert the CD-ROM into the CD-ROM or DVD-ROM drive.

If the Windows Autorun feature is turned on, the installation start-up screen appears automatically.

2 Continue with the installation as prompted.

If the Windows Autorun feature is not turned on

Display the contents of the CD-ROM by using "My Computer" etc., and double-click on "Readme.txt". The installation method is described in this file.

■ Using the Application Software and Online Help

This section explains how to start the Application Software and view the online help.

1 Click the Windows "Start" button and select "Programs", "YAMAHA AP-U70 (or DP-U50)", "AP-U70 (or DP-U50)" in this order.

The Application Software starts.

2 To view the online help, click the Windows "Start" button and select "Programs", "YAMAHA AP-U70 (or DP-U50)", "Help" in this order.

The online help, which explains how to use the Application Software, starts.

Note

Never disconnect the USB cable while starting up the Application Software. If disconnected, the computer may hang.

■ Uninstalling the Application Software

This section explains how to uninstall the Application Software.

1 Terminate the Application Software and online help.

2 Click the Windows "Start" button and select "Settings", and then "Control Panel".

The Control Panel window appears.

3 Double-click the "Add/Remove Programs" icon.

The "Add/Remove Programs" window appears.

4 Select "YAMAHA AP-U70 (or DP-U50) Application" in the software list.

"YAMAHA AP-U70 (or DP-U50) Application" is highlighted.

5 Click the "Change/Remove" button and continue as prompted.

Macintosh computer

■ Connections and setup

1 Plug the AC power cord of this unit into the AC outlet.

2 Start the Macintosh.

3 Connect this unit to a USB port on the computer using the supplied USB cable.

The driver software for USB audio is automatically installed.

4 Press the power switch of this unit to turn on this unit.

Some messages are shown on the display.

Notes

- The sound output destination cannot be changed from “Choose a device for sound output” on the “Control Panels”. When using the internal speaker of the Macintosh as the sound output destination, disconnect the USB cable connecting this unit and the Macintosh.
- When using headphones with this unit connected to the USB port on the Macintosh, use the headphone jack on this unit, not the jack on the Macintosh.
- Since the Macintosh issues a start-up sound at power-on before the sound signal via the USB connection is activated, the start-up sound cannot be issued via the USB connection. To play the start-up sound via this unit, you need a separate analog connection between this unit and the Macintosh. (When USB MIX is set to “ON” from the Setup Panel of the Application Software, you can mix the start-up sound via the analog connection with the same sound via the USB connection without making any change in the input selector settings.)

Checking sound output and adjusting volume

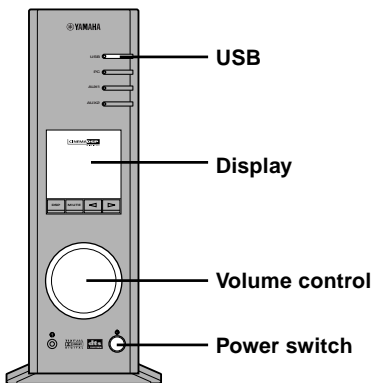

1 Make the following operations on the front panel of this unit.

- Press the USB input selector key.
- Use the volume control to adjust the volume. (Set the control to about “30”.)

2 Check that the sound is output normally by outputting “Alert Sounds”, etc. from “Sound” on the “Control Panels” on the Macintosh.

3 Adjust the volume by dragging the “Sound” tab on the “Control Panels”. Set the tab between the center and max. position.

Next, install the Application Software and Online Help from the supplied CD-ROM.

■ Installing the Application Software

1 Insert the CD-ROM into the CD-ROM or DVD-ROM drive.

The CD-ROM includes the simple installer “AP-U70 (or DP-U50) Installer” and the installation data folder.

2 Double-click the simple installer “AP-U70 (or DP-U50) Installer” to start it.

The Application Software and Online Help are installed on the hard disk.

* Files installed by the simple installer

The simple installer “AP-U70 (or DP-U50) Installer” copies the “AP-U70 (or DP-U50) Application” folder in the installation data folder to a specified location. It additionally copies the “AP-U70 (or DP-U50) Help” folder into the “Help” folder in the “System Folder” on the startup disk.

- * To install the Application Software without using the simple installer, follow the instructions below.

Installing the Application Software without using the simple installer “AP-U70 (or DP-U50) Installer”:

1 Copy the “AP-U70 (or DP-U50) Application” folder in the installation data folder to any hard disk.

2 Copy the “AP-U70 (or DP-U50) Help” folder in the installation data folder to the “Help” folder in the “System Folder” on the startup disk.

You can refer to this Online Help file with Mac Help.

■ How to use the Application Software and Online Help

All operating instructions for the Application Software is available from the Online Help. To refer to the instructions, select the Online Help from the menu displayed upon activation of the Application Software.

Relationship between operation on this unit and the Application Software

When an operation button or the volume control on this unit is operated with the Application Software activated, the display screen of the Application Software automatically changes to reflect the changes made on the unit. When this unit is operated as above while the display shows the screens of the Application Software data and another program, the display of the other program (for example, the playback display of QuickTime) may be partially disturbed as the screen of the Application Software responds to the operation on this unit. To avoid this, operate this unit without activating the Application Software.

APPENDIX

Troubleshooting

Refer to the chart below if this unit does not function properly. If the problem you are experiencing is not listed below or if the instructions given below do not help, disconnect the power cord and contact your authorized YAMAHA dealer or service center.

Problem	Cause	Remedy
The unit cannot be turned on though the power switch on the front panel or the POWER key on the remote control is pressed.	The power cord is not plugged in or is not completely inserted.	Firmly plug in the power cord.
No sound.	This unit is in the standby mode.	Turn on this unit by pressing the Power switch on the front panel or the POWER key on the remote control.
	Incorrect output cord connections.	Connect the cords properly. If the problem persists, the cords may be defective.
Application does not start.	This unit and the computer is not connected with the USB cable.	Connect this unit and the computer with the USB cable.
	The power cord is not plugged in or is not completely inserted.	Firmly plug in the power cord.
The driver software cannot be installed successfully.	The USB cable is not firmly connected between this unit and the computer.	Disconnect the USB cable, and then connect it firmly again.
	The power cord is not plugged in or is not completely inserted.	Firmly plug in the power cord.
Using this unit affects TV reception or the performance of other equipment.	The equipment may be too close to this unit.	Move the equipment away from this unit.

Depending on some computer hardware or operating systems, all functions of this unit cannot be used. You can refer to the following Yamaha website for details and related information.

<http://www.yamaha.co.jp/audio/>



YAMAHA ELECTRONICS CORPORATION, USA 6660 ORANGETHORPE AVE., BUENA PARK, CALIF. 90620, U.S.A.
YAMAHA CANADA MUSIC LTD. 135 MILNER AVE., SCARBOROUGH, ONTARIO M1S 3R1, CANADA
YAMAHA ELECTRONIK EUROPA G.m.b.H. SIEMENSSTR, 22-34, 25462 RELLINGEN, BEI HAMBURG, F.R. OF GERMANY
YAMAHA ELECTRONIQUE FRANCE S.A. RUE AMBROISE CROIZAT BP70 CROISSY-BEAUBOURG 77312 MARNE-LA-VALLEE CEDEX02, FRANCE
YAMAHA ELECTRONICS (UK) LTD. YAMAHA HOUSE, 200 RICKMANSWORTH ROAD WATFORD, HERTS WD1 7JS, ENGLAND
YAMAHA SCANDINAVIA A.B. J A WETTERGRENS GATA 1, BOX 30053, 400 43 VASTRA FROLUNDA, SWEDEN
YAMAHA MUSIC AUSTRALIA PTY, LTD. 17-33 MARKET ST., SOUTH MELBOURNE, 3205 VIC., AUSTRALIA

YAMAHA CORPORATION

Printed in Malaysia 

V664210



PERSONAL AMPLIFIER

AP-U70

PERSONAL SOUND PROCESSOR

DP-U50

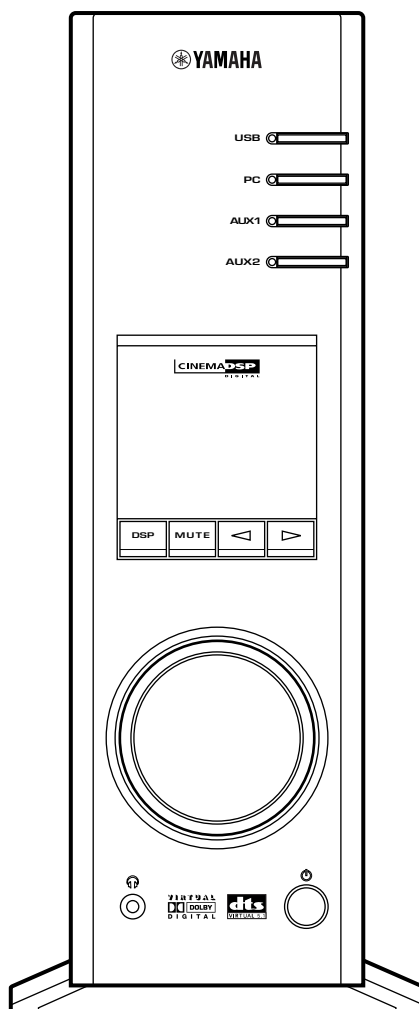

OPERATION MANUAL

MANUEL D'UTILISATION

IMPORTANT SAFETY INSTRUCTIONS

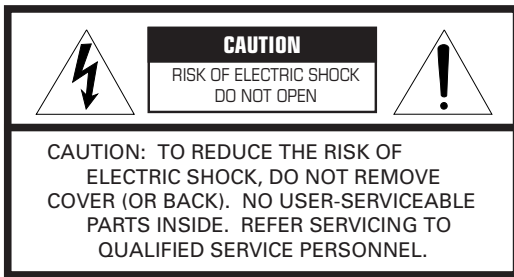

• Explanation of Graphical Symbols

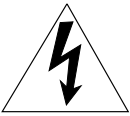

The lightning flash with arrowhead symbol, within an equilateral triangle, is intended to alert you to the presence of uninsulated "dangerous voltage" within the product's enclosure that may be of sufficient magnitude to constitute a risk of electric shock to persons.



The exclamation point within an equilateral triangle is intended to alert you to the presence of important operating and maintenance (servicing) instructions in the literature accompanying the appliance.

WARNING

TO REDUCE THE RISK OF FIRE OR ELECTRIC SHOCK, DO NOT EXPOSE THIS APPLIANCE TO RAIN OR MOISTURE.

IMPORTANT

Please record the serial number of this system in the space below.

Model:

Serial No.:

The serial number is located on the rear of the main unit.

Retain this Owner's Manual in a safe place for future reference.

- 1 Read these instructions.
- 2 Keep these instructions.
- 3 Heed all warnings.
- 4 Follow all instructions.
- 5 Do not use this apparatus near water.
- 6 Clean only with dry cloth.
- 7 Do not block any ventilation openings. Install in accordance with the manufacturer's instructions.
- 8 Do not install near any heat sources such as radiators, heat registers, stoves, or other apparatus (including amplifiers) that produce heat.
- 9 Do not defeat the safety purpose of the polarized or grounding-type plug. A polarized plug has two blades with one wider than the other. A grounding type plug has two blades and a third grounding prong. The wide blade or the third prong are provided for your safety. If the provided plug does not fit into your outlet, consult an electrician for replacement of the obsolete outlet.
- 10 Protect the power cord from being walked on or pinched particularly at plugs, convenience receptacles, and the point where they exit from the apparatus.
- 11 Only use attachments/accessories specified by the manufacturer.
- 12 Use only with the cart, stand, tripod, bracket, or table specified by the manufacturer, or sold with the apparatus. When a cart is used, use caution when moving the cart/apparatus combination to avoid injury from tip-over. 
- 13 Unplug this apparatus during lightning storms or when unused for long periods of time.
- 14 Refer all servicing to qualified service personnel. Servicing is required when the apparatus has been damaged in any way, such as power-supply cord or plug is damaged, liquid has been spilled or objects have fallen into the apparatus, the apparatus has been exposed to rain or moisture, does not operate normally, or has been dropped.

COMPLIANCE INFORMATION STATEMENT (DECLARATION OF CONFORMITY PROCEDURE)

Responsible Party: Yamaha Electronics Corp.,
Address: 6660 Orangethorpe Ave.
Buena Park, CA90620
Telephone: 714-522-9105
Type of Equipment: Amplifier/sound processor
Model Name: AP-U70/DP-U50

This device complies with Part 15 of the FCC Rules.

Operation is subject to the following conditions:

- 1) this device may not cause harmful interference, and
- 2) this device must accept any interference received including interference that may cause undesired operation.

See the user manual instructions if interference to radio reception is suspected.

FCC INFORMATION (for US customers only)

1. IMPORTANT NOTICE: DO NOT MODIFY THIS UNIT!

This product, when installed as indicated in the instructions contained in this manual, meets FCC requirements. Modifications not expressly approved by Yamaha may void your authority, granted by the FCC, to use the product.

2. IMPORTANT: When connecting this product to accessories and/or another product use only high quality shielded cables. Cable/s supplied with this product **MUST** be used. Follow all installation instructions. Failure to follow instructions could void your FCC authorization to use this product in the USA.

3. NOTE: This product has been tested and found to comply with the requirements listed in FCC Regulations, Part 15 for Class "B" digital devices. Compliance with these requirements provides a reasonable level of assurance that your use of this product in a residential environment will not result in harmful interference with other electronic devices. This equipment generates/uses radio frequencies and, if not installed and used according to the instructions found in the users manual, may cause interference harmful to the operation of other electronic devices. Compliance with FCC regulations does not guarantee that interference will not occur in all installations. If this product is found to be the source of interference, which can be determined by turning the product "OFF" and "ON", please try to eliminate the problem by using one of the following measures:

Relocate either this product or the device that is being affected by the interference.

Utilize power outlets that are on different branch (circuit breaker or fuse) circuits or install AC line filter/s.

In the case of radio or TV interference, relocate/reorient the antenna. If the antenna lead-in is 300 ohm ribbon lead, change the lead-in to coaxial type cable.

If these corrective measures do not produce satisfactory results, please contact the local retailer authorized to distribute this type of product. If you can not locate the appropriate retailer, please contact Yamaha Electronics Corp., 6660 Orangethorpe Ave. Buena Park, CA90620

The above statements apply **ONLY** to those products distributed by Yamaha Corporation of America or its subsidiaries.

We Want You Listening For A Lifetime

YAMAHA and the Electronic Industries Association's Consumer Electronics Group want you to get the most out of your equipment by playing it at a safe level. One that lets the sound come through loud and clear without annoying blaring or distortion – and, most importantly, without affecting your sensitive hearing.

Since hearing damage from loud sounds is often undetectable until it is too late, YAMAHA and the Electronic Industries Association's Consumer Electronics Group recommend you to avoid prolonged exposure from excessive volume levels.



INTRODUCTION

About this manual

- This manual explains how to operate this unit. Refer to the separate “**SET UP MANUAL**” for how to connect this unit with other equipment, and to install the Application Software, etc. to your computer from the supplied CD-ROM.
- This manual mainly explains how to operate this unit using the front panel of this unit and the supplied remote control.
- When this unit and your computer is connected with the USB cable, and the supplied Application Software is installed on the computer, you can operate this unit from the computer using the Application Software. Refer to the online help of the Application Software for how to use the Application Software.

The Application Software extends the use of this unit with additional functions which cannot be used with the front panel keys or the remote control. This manual introduces those functions by the following style.

Example:



■ Adjusting USB MIX LEVEL

When an input other than the USB terminal is selected, you can listen to the mixed sound signals from the selected input and from the USB terminal. Also, the mixing ratio of the signals from the USB terminal can be adjusted.

* Refer to the online help of the Application Software for details.



This manual also offers brief explanations about the functions available with the Application Software on page 15–18. Refer to the online help of the Application Software for details of how to use the functions.

Features

- This unit brings high-quality audio to your computer.
- The USB interface allows remote control of this unit from your computer, using the supplied Application Software, plus various audio I/O options.
- Ideal for use with computer games, internet music, CD-ROM, DVD, multimedia software, and more.
- Yamaha's Near-Field Cinema DSP (Digital Sound field Processing) technology provides live music performance and movie theater surround sound. The sound effect of DSP is also available for headphone listening.
- Sophisticated Virtual 3D technology reproduces multichannel sources such as Dolby Digital* and DTS** providing a realistic surround effect with just two speakers.
- This unit is compatible with the following audio signals received via a USB connection: multi-channel (two, four and six channels) audio, high quality digital audio of 24 bits/48 kHz and Dolby Digital-encoded signals. (Some operating systems and software programs do not support this feature.)



* Manufactured under license from Dolby Laboratories. “Dolby”, “Pro Logic” and the double-D symbol are trademarks of Dolby Laboratories. Confidential Unpublished Works. ©1992–1997 Dolby Laboratories, Inc. All rights reserved.



** Manufactured under license from Digital Theater Systems, Inc. US Pat. No. 5,451,942 and other world-wide patents issued and pending. “DTS”, “DTS Digital Surround”, are trademarks of Digital Theater Systems, Inc. Copyright 1996 Digital Theater Systems, Inc. All Rights Reserved.

CONTENTS

CAUTION 2	CAUTION
OUTLINE OF THIS UNIT Main features of this unit 3 Virtual 3D 4 Digital Sound Field Processing (DSP)..... 4	OUTLINE OF THIS UNIT
CONTROLS AND THEIR FUNCTIONS Front panel & Remote control 5 About the display 7	CONTROLS & THEIR FUNCTIONS
BASIC OPERATION Playing a source 8 Using sound field programs 10 Recording 11	BASIC OPERATION
ADVANCED OPERATION Adjusting surround effect 13 Setting USB channel 14 Operating this unit with the Application Software 15	ADVANCED OPERATION
APPENDIX Troubleshooting 19 Specifications 20	APPENDIX

CAUTION: Read this before operating this unit

1. To assure the finest performance, please read this manual carefully. Keep it in a safe place for future reference.
2. Install this unit in a cool, dry, clean place – away from windows, heat sources, sources of excessive vibration, dust, moisture and cold. Avoid sources of humming (transformers, motors). To prevent fire or electric shock, do not expose the unit to rain or water.
3. Never open the cabinet. If something drops into the set, contact your dealer.
4. Do not use force on switches, controls or connection wires. When moving the unit, first disconnect the power plug and the wires connected to other equipment. Never pull the wires themselves.
5. The openings on the unit cover assure proper ventilation of the unit. If these openings are obstructed, the temperature inside the unit will rise rapidly; therefore, avoid placing objects against these openings. To prevent fire or damage, install the unit in a well-ventilated area.
<Europe and U.K. models only>
To prevent fire or damage, be sure to allow a space of at least 10 cm behind, 10 cm on both sides and 10 cm above the top panel of the unit.
6. The voltage used must be the same as that specified on this unit. Using this unit with a higher voltage than specified is dangerous and may result in fire or other accidents. YAMAHA will not be held responsible for any damage resulting from use of this unit with a voltage other than that specified.
7. Always set the volume to minimum before starting audio playback. Increase the volume gradually to an appropriate level after playback has been started.
8. Do not attempt to clean the unit with chemical solvents as this might damage the finish. Use a clean, dry cloth.
9. Be sure to read the “TROUBLESHOOTING” section regarding common operating errors before concluding that the unit is faulty.
10. When not planning to use this unit for a long period (i.e., vacation, etc.), disconnect the AC power plug from the wall outlet.
11. To prevent lightning damage, disconnect the AC power plug when there is an electric storm.
12. Grounding or polarization – Precautions should be taken so that the grounding or polarization of appliances is not defeated.

For U.K. customers

If the socket outlets in the home are not suitable for the plug supplied with this appliance, it should be cut off and an appropriate 3 pin plug fitted. For details, refer to the instructions described below.

Note: The plug severed from the mains lead must be destroyed, as a plug with bared flexible cord is hazardous if engaged in a live socket outlet.

SPECIAL INSTRUCTIONS FOR U.K. MODEL

IMPORTANT:

THE WIRES IN MAINS LEAD ARE COLOURED IN ACCORDANCE WITH THE FOLLOWING CODE:

Blue: NEUTRAL

Brown: LIVE

As the colours of the wires in the mains lead of this apparatus may not correspond with the coloured markings identifying the terminals in your plug, proceed as follows: The wire which is coloured BLUE must be connected to the terminal which is marked with the letter N or coloured BLACK. The wire which is coloured BROWN must be connected to the terminal which is marked with the letter L or coloured RED. Making sure that neither core is connected to the earth terminal of the three pin plug.

For Canadian Customers

To prevent electric shock, match wide blade of plug to wide slot and fully insert.

This Class B digital apparatus complies with Canadian ICES-003.

When this unit is turned off by pressing the power switch on the front panel or the POWER key on the remote control, this unit turns into the standby mode. In this mode, this unit is designed to consume a small amount of power. This unit's power supply is completely cut off from the AC line only when the AC power cord is disconnected.

OUTLINE OF THIS UNIT

Main features of this unit

Using Yamaha's unique DSP technology, this unit can bring excitement and realism to any audio source by simulating the acoustic environments of concert halls, movie theaters, and so on with only two speakers. With its stylish, vertical design, this unit allows you to use various audio sources, including your computer, CD player, MD or tape deck, as shown below.

Although this unit can be used as part of a typical hi-fi system, connecting it to your computer via the USB terminal, and running the supplied Application Software, allows you to remotely control this unit from your computer and edit the sound field programs.

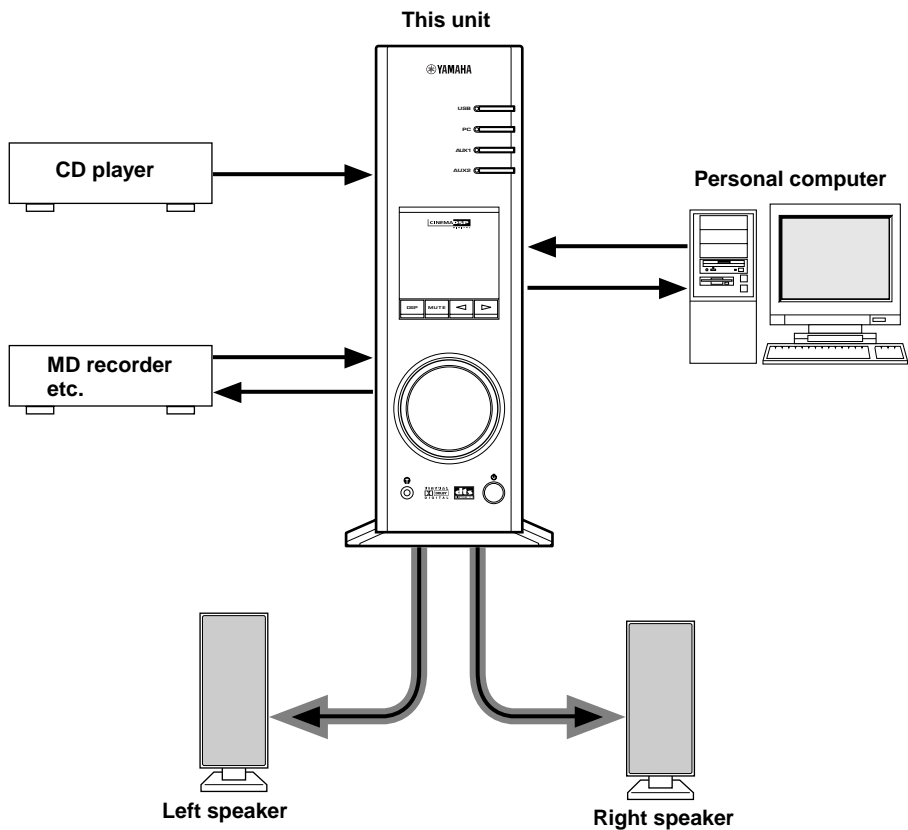

[For DP-U50 only]

This unit cannot be connected with speakers directly. Connect this unit to speakers with a built-in amplifier, a mini-component system, etc., or connect this unit to speakers via a power amplifier.

* Refer to the separate "SET UP MANUAL" for connections.

Virtual 3D

Surround sound typically requires several speakers situated in front of and behind the listening position, which requires a substantial amount of space that may not always be available. This unit uses Yamaha's unique "Virtual 3D (three-dimensional)" technology to simulate a typical surround sound system using only two speakers. Virtual

3D, which is used by this unit's sound field programs, simulates the surround effect provided by rear and center speakers, creating "virtual" surround speakers, as shown, so even with only two front speakers, you can still enjoy surround sound.

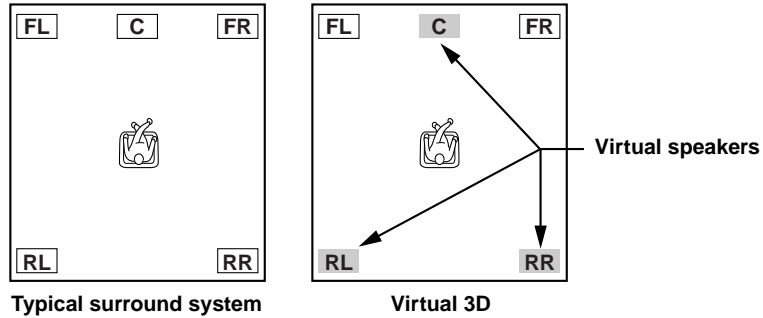

Digital Sound Field Processing (DSP)

When you listen to a performance in a concert hall, jazz club, or other live music venue, you not only hear the direct sound coming from the musical instruments and singers, but also the "early reflections" and natural reverberation. Early reflections are the initial sound waves that bounce off the floor, ceiling, and walls. Natural reverberation is made up of sound waves that gradually attenuate as they bounce repeatedly off multiple surfaces.

Since the way you hear early reflections and reverberation depends on the shape and size of the building as well as the material and construction of the walls and ceiling, each venue has its own unique "sound," called its "sound field." At Yamaha, we have measured all the elements that make up a typical sound field—direction and level of the reflections, band-width characteristics, and delay times—at famous concert halls and opera houses around the world. The information gained in this process has been converted into programs that can be reproduced using Yamaha's DSP technology. Using its on-board DSP, this unit can process any audio source and recreate the atmosphere of the original venue.

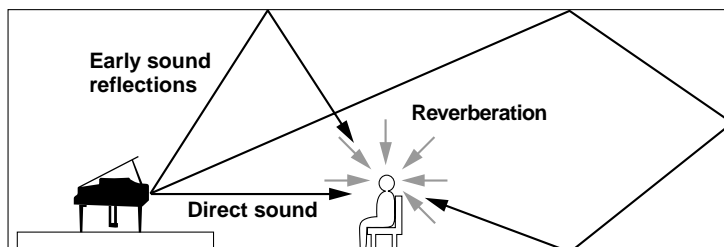

CONTROLS AND THEIR FUNCTIONS

Front panel & Remote control

Front panel

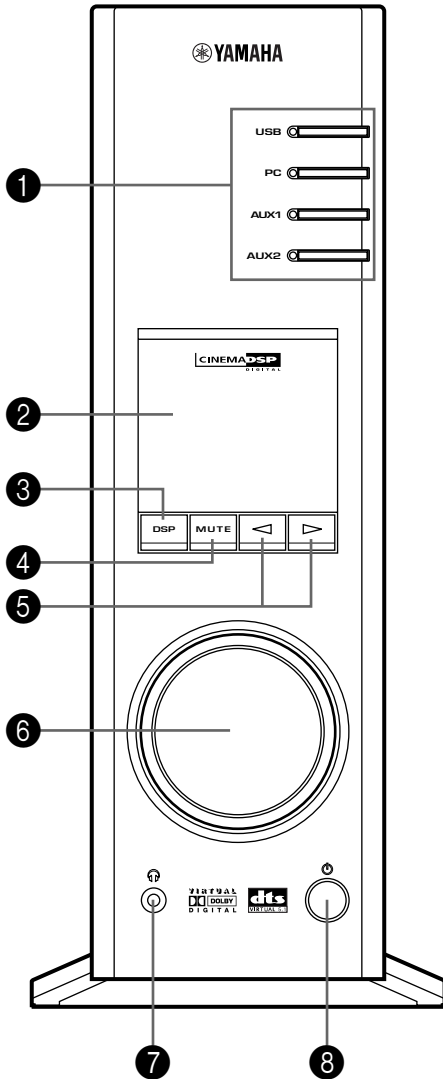

Remote control

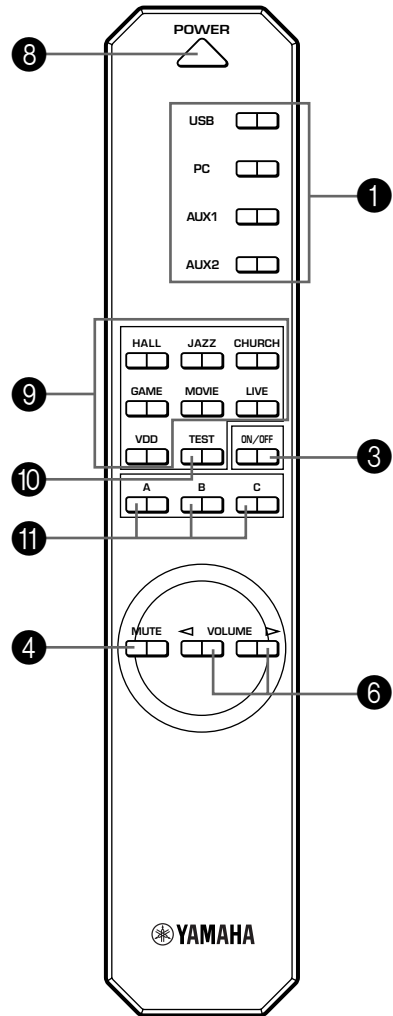

1 Input selectors & indicators

These four keys, explained below, are used to select the input source. The indicator of the selected source lights up.

● **USB key**

This key selects input signals sent from your computer by way of the USB terminal.

● **PC key**

This key selects your computer as the input source. Pressing this key repeatedly selects the digital (DIGITAL PC COAX IN or DIGITAL PC OPT IN) or analog (ANALOG PC IN) input. The DIGITAL PC OPT IN has priority over the DIGITAL PC COAX IN, so if you connect to both inputs, the signal received at the DIGITAL PC OPT IN is used.

● **AUX1 key**

This key selects the equipment connected to the ANALOG AUX 1 IN or DIGITAL AUX 1 OPT IN connector as the input source. Pressing this key repeatedly selects the digital or analog input.

● **AUX2 key**

This key selects the equipment connected to the ANALOG AUX 2 IN connectors as the input source.

2 Display

The display shows various settings, selected input source, sound field program and various other information.

3 DSP key [front panel]

ON/OFF key [remote control]

This key activates the sound field programs produced by the internal DSP.

4 MUTE key

This key is used to cut off sound output temporarily. Turning the volume control on the front panel or pressing the **VOLUME** keys on the remote control restores sound output. Pressing this key again also restores sound output.

* Sound output will also be restored by changing the status of this unit between standby and power-on, changing the input source or the sound field program, and so on.

5 </> (Down/Up) keys

These keys are used to select sound field programs. These keys only work when the internal DSP is activated (when "DSP" is illuminated on the display).

6 Volume control [front panel]

< VOLUME > (Down/Up) keys [remote control]

These control and keys adjust the speaker and headphone volume. The volume cannot be adjusted when this unit is in the standby mode.

7 Headphone jack

Stereo headphones can be connected to this mini-jack for private listening, with Virtual 3D effects specifically tailored for headphone listening.

8 Power switch (⏻) [front panel]

POWER key [remote control]

Each click of this switch changes the status of this unit between standby mode and power on.

* In the standby mode, this unit can be turned on remotely from your computer, using the supplied Application Software. Note that this unit uses a small amount of power in the standby mode.

9 Sound field program selector keys

Each of these keys selects the corresponding sound field program.

10 TEST key

This key is used to output a test tone. The test tone is used when adjusting the volume balance between the left and right front speakers, or among all speakers in the system including the virtual rear speakers. (Refer to page 13 for details.)

11 Custom keys (A, B, C)



These keys are available when this unit and your computer are connected with the USB cable, and the supplied Application Software is installed on the computer.

Each of these keys can be programmed with a set of commands (input selector, sound field program, volume setting, etc.) by using the Application Software. After storing, simply pressing each key will execute the stored command.

* Refer to the online help of the Application Software for details.



About the display

This section explains what the various display indicators mean.

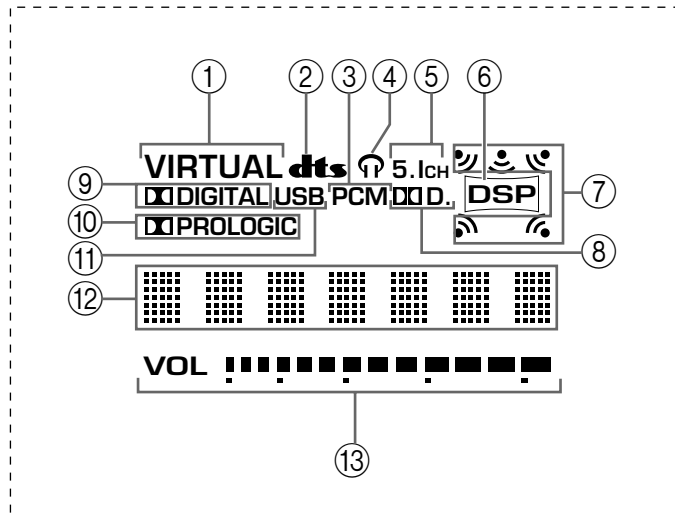

- ① **VIRTUAL**
This indicator appears when this unit is using Virtual 3D.
- ② **dts (DTS)**
This indicator appears when an input signal is decoded with DTS.
- ③ **PCM**
This indicator appears when a PCM digital audio signal is selected as the input source.
- ④ 
This indicator appears when headphones are connected to the headphone jack of this unit.
- ⑤ **5.1CH**
This indicator appears when a 5.1 channel digital audio signal is selected as the input source.
- ⑥ **DSP**
This indicator appears when the DSP is processing the input signal.
- ⑦ **Sound output indicators**
This indicator shows the currently used speakers (including virtual speakers).
- ⑧ **D.**
This indicator appears when an audio signal encoded with Dolby Digital is selected as the input source.
- ⑨ **DIGITAL (DOLBY) DIGITAL**
This indicator appears when an input signal is decoded with Dolby Digital.
- ⑩ **PROLOGIC (DOLBY) PROLOGIC**
This indicator appears when an input signal is decoded with Dolby ProLogic.
- ⑪ **USB**
This indicator appears when audio signals are sent or received via the USB terminal.
- ⑫ **Multi-information display**
Various messages and information appear here.
- ⑬ **VOL (volume)**
This indicator graphically displays the volume level setting.

BASIC OPERATION

Playing a source

This section explains how to turn on this unit and select input sources. If any external audio equipment is connected to this unit, turn it on first.

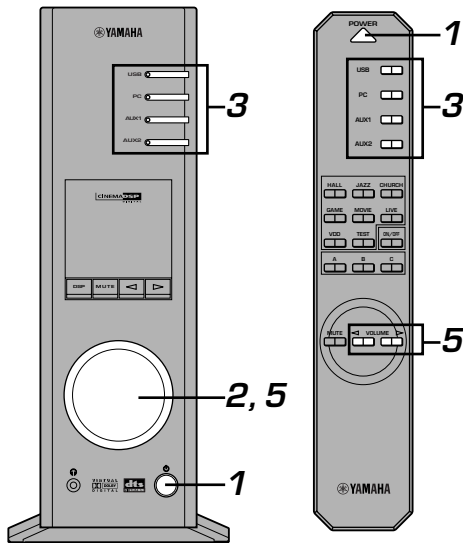

1 Turn on this unit.

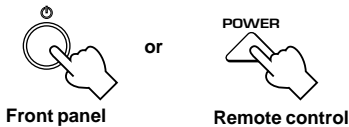

The message “Hello” appears for a few seconds, and this unit returns to the state in which it was last used (e.g., the input source that was selected when this unit was turned off is selected).

2 Decrease the volume to minimum (MIN).

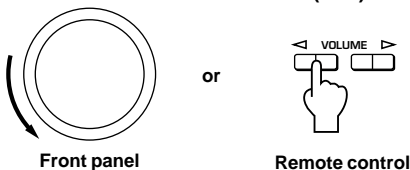

3 Select an input source by using the input selector keys.

The corresponding indicator on the front panel lights up.

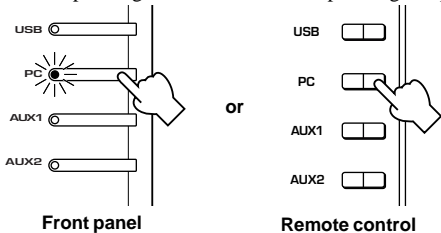

Refer to the explanation on the right side for details about using the input selector keys.

4 Start the selected input source.

5 Adjust the volume to the desired level.

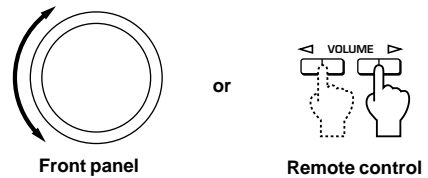

6 As you prefer, use a sound field program.

Refer to page 10 for details about the sound field programs.

About the input selector keys

Each of the input selector keys selects the following input signals.

USB: Press the **USB** key to select input signals at the USB terminal.

PC: Press the **PC** key repeatedly to select the PC inputs: “PC_DIGT” and “PC_ANLG”. PC_DIGT selects the DIGITAL PC COAX IN or DIGITAL PC OPT IN, and PC_ANLG selects the ANALOG PC IN.

Note: The DIGITAL PC OPT IN has priority over the DIGITAL PC COAX IN, so if you connect to both inputs, the signal received at the DIGITAL PC OPT IN is used.

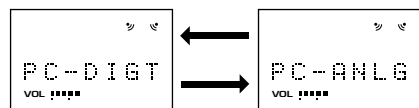

AUX1: Press the **AUX1** key repeatedly to select the inputs: “AUX1_DG” and “AUX1_AN”. AUX1_DG selects the equipment connected to the DIGITAL AUX 1 OPT IN, and AUX1_AN selects the equipment connected to the ANALOG AUX 1 IN connector as the input source.

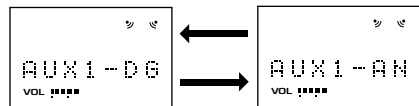

AUX2: Press the **AUX2** key to select the equipment connected to the ANALOG AUX 2 IN connectors as the input source.

Note

When an input selector key is pressed, the display shows the name of the selected input source for a short while, and then shows the currently selected sound field program. When no sound field program is selected, "THROUGH" is shown on the display.



The names of input sources shown on the display can be changed with the Application Software. Refer to the Online Help of the Application Software for details.

**■ To cut off sound output temporarily**

Press the **MUTE** key. To restore sound output, turn the volume control on the front panel or press the **VOLUME** keys on the remote control. Pressing the **MUTE** key again also restores sound output.

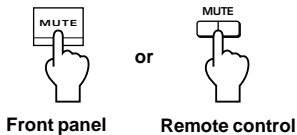
**Note**

Sound output will also be restored by changing the status of this unit between standby and power-on modes, changing the input source or the sound field program, using the test tone, or using the **A, B, C** keys on the remote control.

■ When you listen with headphones

Connect the headphones to the **headphone jack**. No sound will be outputted from the speakers.

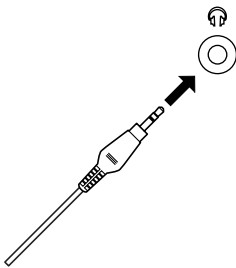
**Note****[DP-U50 only]**

The PRE OUT terminals on the rear panel will output signals even if headphones are used.

■ When you have finished using this unit

Set this unit to the standby mode by pressing the **power** switch on the front panel or the **POWER** key on the remote control.

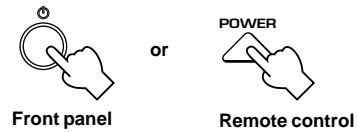
**Note**

When not planning to use this unit for a long period (i.e., vacation, etc.), disconnect the AC power plug from the wall outlet.

**■ Setting USB MIX**

When an input other than the USB terminal is selected, you can listen to the mixed signals from the selected input and from the USB terminal. Also, the mixing ratio of the signals from the USB terminal can be adjusted.

* Refer to the online help of the Application Software for details.

■ Setting graphic equalizer

You can adjust the frequency characteristics as you prefer by using the 7-band graphic equalizer.

* Refer to the online help of the Application Software for details.

Notes

- Some setting changes may be needed on the computer to reproduce signals sent from the computer to this unit via the USB connection. Refer to the separate "SET UP MANUAL" for details.
- Some setting changes may be needed on the computer to reproduce signals sent from the computer to this unit via a sound card, etc.

Automatic power saving function

If there is no operation on this unit's front panel, the remote control or the Application Software for about 24 hours with the power of this unit on, this unit will automatically be set to the standby mode.

Using sound field programs

This unit's built-in DSP (Digital Sound field Processor) can simulate various acoustic environments, including a concert hall and movie theater, with its seven sound field programs. For best results, choose a program appropriate for the selected audio source.

First follow steps 1–5 of “Playing a source” on page 8.

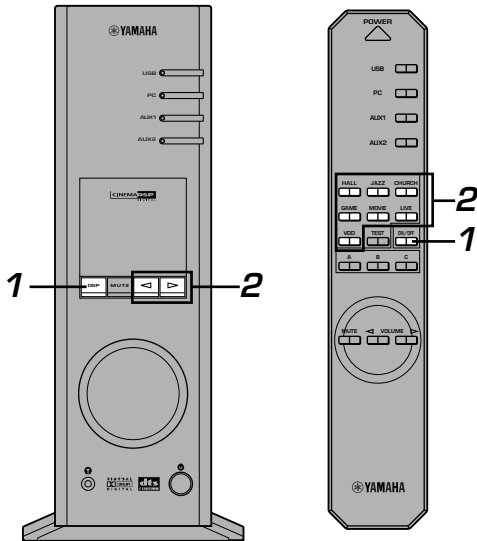

1 Turn on the DSP.

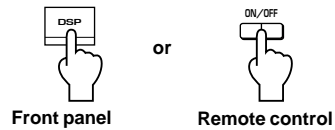

The name of the selected sound field program appears on the display.

2 Select the desired sound field program.

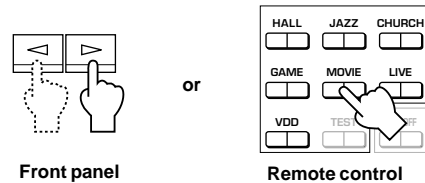

Front panel: Pressing ◀ or ▶ repeatedly changes the program.

Remote control: Press the key of the desired program.

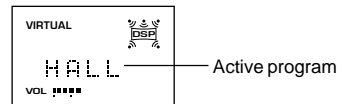

The following programs are available.

	Program	Feature	Note
HI-FI DSP (for music sources)	HALL (CONCERT HALL EUROPE)	This program simulates the sound field of a medium-sized hall, with a beautiful and rich reverberation.	These programs create a sound field that feels real, just as if you were actually there.
	JAZZ (JAZZ CLUB VILLAGE GATE)	This program simulates the sound field of a famous New York jazz club.	
	CHURCH (CHURCH ROYAUMONT)	This program simulates the sound field of a Gothic church, with the unique effect of sound reverberating back and forth in a domed ceiling.	
CINEMA DSP (for video sources)	GAME (GAME AMUSEMENT)	This program adds depth and surround effects to computer games, enhancing the gaming experience.	For these sound field programs, a Yamaha DSP effect is applied to Dolby Pro Logic, Dolby Digital, DTS, and other surround sounds for motion-picture audio. *: HP3D When headphones are connected, this program changes to a simulation program called HP3D, which is specifically tailored for headphone listening.
	MOVIE (MOVIE THEATER)	The realism provided by this program gives the impression that you're actually in the scene.	
	LIVE (LIVE CONCERT)	This program produces an enthusiastic atmosphere and lets you feel that you are in the midst of the action, as if attending an actual jazz or rock concert.	
	VDD [HP3D*] (VIRTUAL DOLBY DIGITAL) DTS [HP3D*] (DTS VIRTUAL 5.1)	This program simulates the effect of Dolby Digital and DTS and is ideal for DVD software encoded using Dolby Digital or DTS.	

Note

Just after selecting a program, the program name scrolls from right to left on the display, and then its short-version name lights up.

■ To turn off the DSP

Press the **DSP** key on the front panel or the **ON/OFF** key on the remote control. "THROUGH" appears on the display.

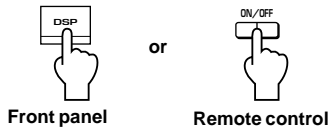

■ Adjusting DSP sound field parameters

The surround effect of each program or the Virtual 3D effect can be adjusted to the desired taste by using the Application Software. Refer to the online help of the Application Software for details.



Recording

Input sources (e.g., a computer or CD player) selected on this unit can be recorded by an MD recorder, tape deck, etc. connected to this unit. Also, input signals can be fed to your computer via the USB connection.

* When a source is recorded using a sound field program, sound field effects are recorded with the source.

■ Recording on an external recording unit

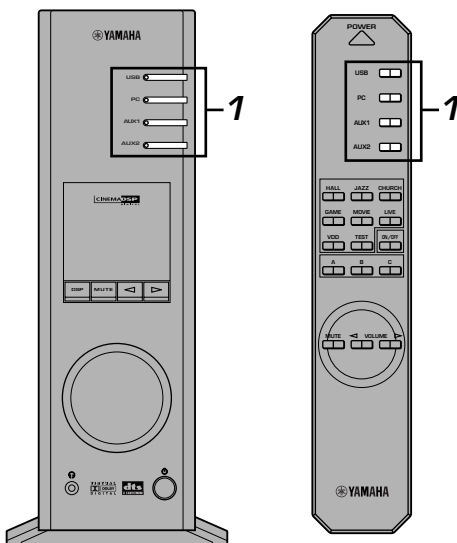

First turn on the external unit to be used, and then this unit.

1 Select the source to be recorded by using the input selector keys.

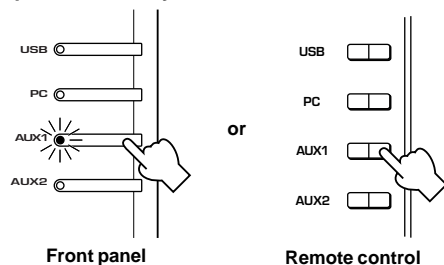

2 Start recording on a recording unit (an MD recorder, tape deck, etc.).

3 Start playing the input source .

■ Playing the recorded result via this unit

Select the input signals sent from the recording unit with the input selector keys.

Notes

- If input signals received at any digital input terminal other than the USB terminal is outputted at the digital output terminal, the sampling frequency for the output signals is the same as that for input signals.
- The sampling frequency for digital signals converted from analog signals on this unit is 44.1 kHz or 48 kHz.
- When digital input signals are outputted at the digital output terminal, track information (CD-text data, automatic track renewal when recording is made on an MD, etc.) is invalid if any sound field program (including the graphic equalizer effect) is used.

■ Recording on a computer (via the USB connection)

When recording or processing signals inputted to your computer via the USB connection, the following setting is needed on the computer.

○ **Selecting Recording Device**

When using Windows

1. Click the Windows “Start” button and select “Settings”, and then “Control Panel”.
2. Double-click the “Multimedia” icon (or the “Sounds and Multimedia” icon).
3. Click the “Audio” tab and select “USB Audio Device” at “Preferred device” of “Recording” (or “Sound Recording”).

When using a Macintosh

Select “USB Audio” as the input device at “Sound” on the Control Panel.

○ **Setting of Recording Software**

Select a sampling frequency from 44.1 kHz and 48 kHz. Select a resolution from 16 bits and 24 bits. The sampling frequency of 44.1 kHz with the resolution of 16 bits produces a sound quality comparable to the compact disc (CD).

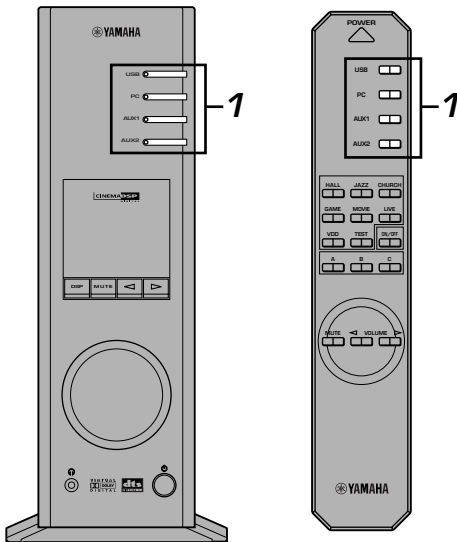

1 Select the source to be recorded by using the input selector keys.

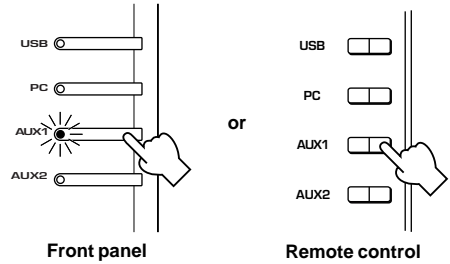

2 Start recording with the recording software on the computer.

3 Start playing the input source.

■ Playing the recorded result via this unit

Press the **USB** input selector key, and play the recorded result on the computer.

Notes

- If the number of USB channels is set to six, recording cannot be made via the USB connection. Reset the number of USB channels to two or four.
- To record digital input signals with a 48 kHz sampling frequency, the frequency of the input signals must be 48 kHz.
- To record sound signals received at an analog or digital input of the sound card etc., and not via the USB connection, select the corresponding device, such as “Sound Card”, from “Preferred device” of “Recording” (or “Sound Recording”) on the computer.
- The sampling frequency and resolution of signals recordable on the computer differ from operating systems. You can refer to the following Yamaha website for details about the related information.

<http://www.yamaha.co.jp/audio/>

Notes

- Please check the copyright laws in your country before recording, compact discs, radio, etc. Recording of copyright material may infringe copyright laws.
- You cannot make a recording from a CD-R, MD, etc. which is a copy of an audio CD, to another CD-R, MD, etc. via the USB connection or the digital terminal connection. Also, you cannot make a recording from an MD which is recorded with digital signals received via the USB connection, to another MD.

ADVANCED OPERATION

Adjusting surround effect

This unit features YAMAHA's unique "Virtual 3D" technology, which provides a virtual surround sound effect with only two speakers. In the sound field of the "Virtual 3D" mode, two virtual rear speakers are provided as well as two front speakers (L, R) to achieve the surround-sound effect.

To optimize the surround-sound effect, adjust the volume of each speaker in the sound field by listening to a series of test tones.

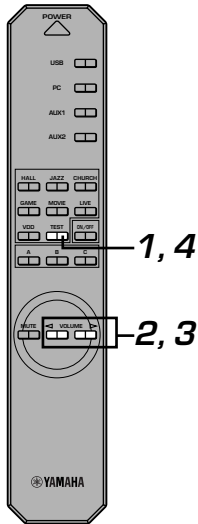

1 Press the TEST key on the remote control.

A test tone is outputted from the following speakers in turn.

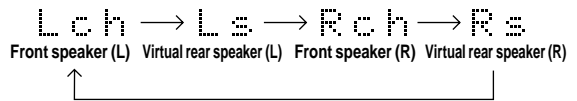

2 When the test tone is outputted from the left (L ch) or right (R ch) front speaker:

Using the VOLUME keys on the remote control adjusts the volume balance between the left and right front speakers.

(Adjustable range: -12 to +12)

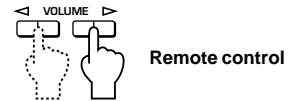

3 When the test tone is outputted from the left (Ls ch) or right (Rs ch) virtual rear speaker:

Using the VOLUME keys on the remote control adjusts the surround effect level.

(Adjustable range: -6 to +6)

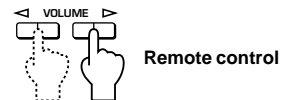

4 When adjustments are finished, press the TEST key.



Test tone stops.

Setting USB channel

Typical USB audio features multi-channel modes, such as four-channel and six-channel modes, in addition to a normal two-channel (stereo) mode. This unit is compatible with each of these modes. When a multi-channel mode is selected, you can receive surround sound of computer games compatible with the 4ch Direct Sound 3D and the surround sound (5.1 channels) of DVD video on this unit via the USB connection and enjoy it as virtual surround sound.

Note that some operating systems and software programs are not multi-channel compatible. Yamaha websites list the names of multi-channel compatible operating systems and software.

Notes

- MacOS9 does not support this feature. Only the two-channel mode can be used. Some versions of Windows also do not support the six and/or four-channel modes. You can refer to the following Yamaha website for details and related information.
<http://www.yamaha.co.jp/audio/>
- When the six channel mode is selected, recording cannot be made to the computer. To record, select the two- or four-channel mode.

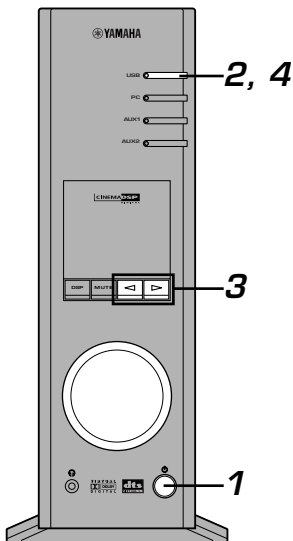

How to set

- * When playback or recording is performed on the computer via the USB connection, terminate the playback or recording software used on the computer.

1 Turn on this unit.

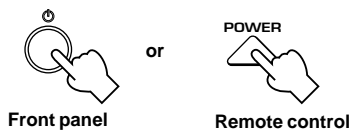

2 Hold down the USB input selector key until the current channel setting is shown (for about two seconds).

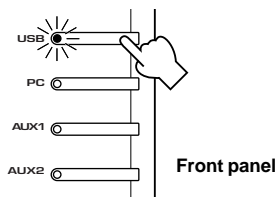

- * When the display of this unit shows "USB" in red, the USB connection is currently used, disabling this USB channel setting function. Terminate the software used on the computer.

3 Press < or > repeatedly until the desired number of channels is shown on the display.

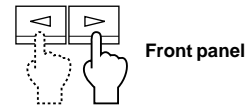

The display changes as follows.

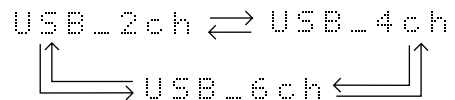

4 Hold down the USB input selector key until the selected number of channels disappears (for about two seconds).

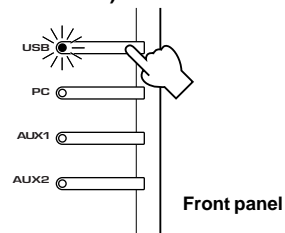

Although no further operation is required, wait a short time until the computer completes the changes in the setting.

Notes

- When the number of channels is changed for the first time, the device driver for the USB audio is installed in the computer. Wait a short time until the computer completes the changes in the setting.
- Do not change the USB channel setting under any circumstance during playback or recording via the USB connection on the computer. If changed, the computer may hang.

Operating this unit with the Application Software

If this unit is connected to your computer via the USB connection and the Application Software is installed in your computer from the supplied CD-ROM, you can operate this unit with the Application Software from your computer. Moreover, the Application Software, once installed on your computer, offers various settings unavailable from this unit or the remote control. (For instructions on how to install the Application Software, see the separate “**SET UP MANUAL**”.)

This section briefly explains how to use the Application Software, the setting screens, and the available functions. For further details, refer to the Online Help of the Application Software.

Notes

- The screen images shown in this section are of the basic screens for the Windows version. The Macintosh version slightly differs in button arrangement, etc.
- The screen design, functions, etc., are subject to change due to version upgrades.

About the Main Panel

The Main Panel allows you to perform the following basic operations.

Tabs are shown at the bottom of the detailed-setting screen. To make detailed settings of the desired function available from any detailed-setting screen, click on the tab for the function.

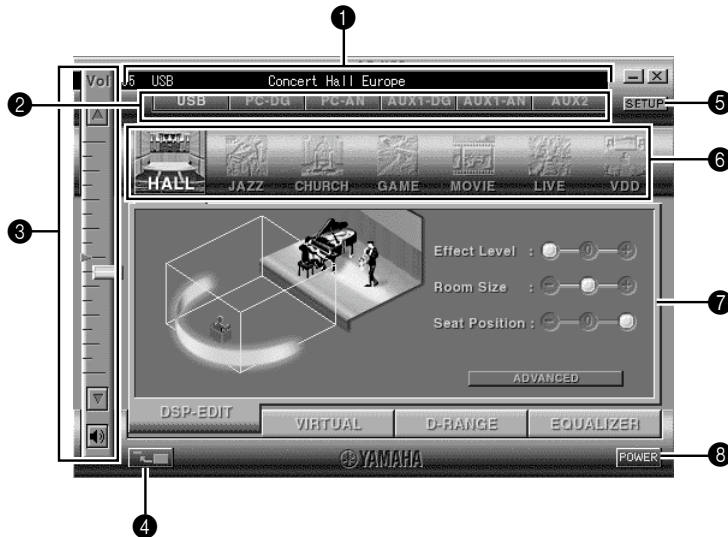

1 Display

This section shows the current status of the volume, input selectors, sound field programs, etc. by characters.

2 Input selector

The input selector allows you to directly change the input source.

3 Volume control

You can adjust the volume by dragging the indicator or by clicking the up (▲) and down (▼) arrows. You can also alternately turn on and off the speakers by clicking the speaker icon below.

4 Changing the panel size

You can minimize the size of the Main Panel.

5 SETUP

Open this panel to change available settings in the Setup panel. (See page 18 for details on the Setup panel.)

6 DSP selector

You can directly select a DSP sound field program.

7 Detailed-setting screens

Select one of the detailed-setting screen tabs at the bottom of the current detailed-setting screen. The new detailed-setting screen will be displayed, where you can make detailed settings of the function.

DSP-EDIT: For adjusting the DSP sound field parameters (See page 16.)

VIRTUAL: For adjusting the virtual 3D (See page 17.)

D-RANGE: For adjusting the dynamic range (See page 17.)

EQUALIZER: For operating the graphic equalizer (See page 17.)

8 POWER

Each click changes the status of the main unit between standby and power-on.

Adjusting DSP sound field parameters

You can adjust various parameters of the DSP sound field programs.

The default parameters of the sound field programs provide great sound, but it is also possible to fine-tune the parameters to suit the acoustics of the room, individual preferences, and program source. Parameter adjustment is required for each selected sound field program.

How to adjust parameters

1. Select the program whose parameters you wish to adjust. (Parameter adjustment is effective for the currently selected program only.)
2. Select the **DSP-EDIT** tab at the bottom of the Main Panel. The basic parameter screen appears.
3. This screen allows you to adjust the basic parameters. Open the “ADVANCED SETTING” panel for adjusting the detailed parameters.

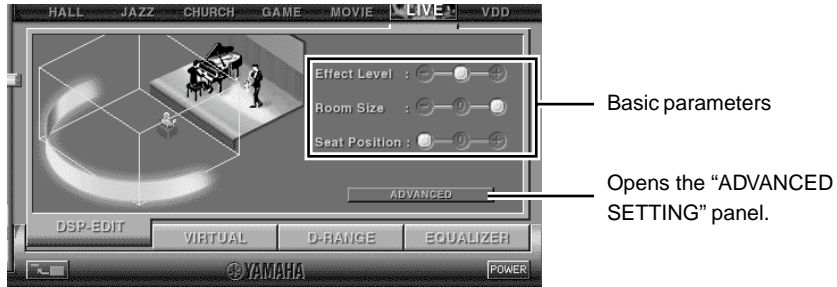

Basic parameters

Effect Level	Selects the level of effect sound from the three levels.
Room Size	Selects the apparent size of the listening space from the three levels.
Seat Position	Selects the simulated listening position from the three positions.

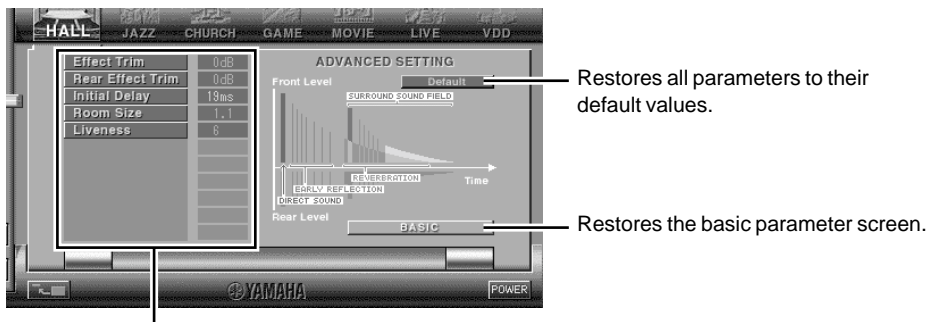

Select a parameter by clicking its name, and adjust the parameter by sliding the indicator at the bottom of the panel.

Detailed parameters

The following parameters are available on the “ADVANCED SETTING” panel. Depending on the selected program and input signals, not all of the parameters can be adjusted.

Effect Trim	Makes fine adjustment of the level of the overall effect sound.
Rear Effect Trim	Makes fine adjustment of the level of the rear effect sound.
Initial Delay	Adjusts the apparent distance from the sound source to the walls.
Room Size	Adjusts the apparent size of the listening space.
Liveness	Adjusts the apparent reflectivity of the walls.
Surround Delay	Adjusts the delay time of the surround sound field.
S. Initial Delay (Surround Initial Delay)	Adjusts the initial delay time of the surround sound field.
S. Room Size (Surround Room Size)	Adjusts the apparent size of the surround sound field.
Reverb Time	Adjusts the duration of reverberations.
Reverb Level	Adjusts the level of reverberations.
Reverb Delay	Adjusts the delay time of reverberations.

Adjusting the virtual 3D effect

The surround sound effect of the virtual 3D sound field is affected by the room configuration and the position of the listener, resulting in sound unique to each environment. The procedure below shows you how to adjust the effect of the virtual 3D to suit your preferences and environment.

Select the **VIRTUAL** tab at the bottom of the Main Panel. The following screen appears.

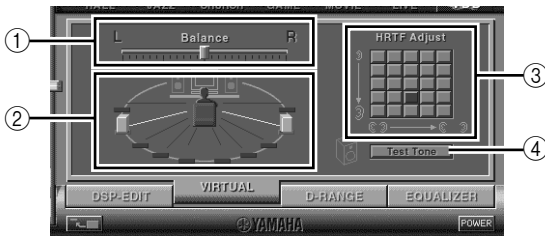

- ① **Balance adjustment**
You can adjust the volume balance between the right and left speakers.
- ② **Virtual rear speaker position setting**
You can set the position of the virtual rear speakers (the speakers are positioned symmetrically.)
- ③ **HRTF (Head-related Transfer Function) adjustment**
You can make an adjustment to personal characteristics.
- ④ **Test tone**
You can output a test tone successively from the speakers at their current positions, allowing setting and adjustment while listening to the tone.

Adjusting the dynamic range

You can set the dynamic range for playing a source with Dolby Digital decoded. This is especially effective for low-volume listening. Select the **D-RANGE** tab at the bottom of the Main Panel. The following screen appears.

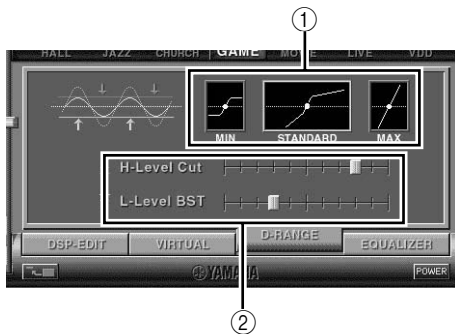

- ① **Dynamic range setting**
Select the dynamic range for playing a source with Dolby Digital decoded from MIN, STANDARD, and MAX. The MAX setting provides a dynamic range of a movie theater while MIN provides a dynamic range suitable for late night, low-volume listening.
- ② **Dynamic range adjustment**
This setting becomes available when you choose STANDARD for the dynamic range. This adjusts high-level cut scale (H-LEVELCut) and low-level boost scale (L-LEVELBST), allowing you to freely adjust the dynamic range between MAX and MIN.

Operating the graphic equalizer

The 7-band graphic equalizer allows you to set the frequency characteristics according to the type of the music that is played and to compensate for the room characteristics and the speakers' frequency characteristics.

This panel is always shown when no DSP sound field program is selected. When a DSP sound field program is selected, selecting the **EQUALIZER** tab at the bottom of the Main Panel will show this panel.

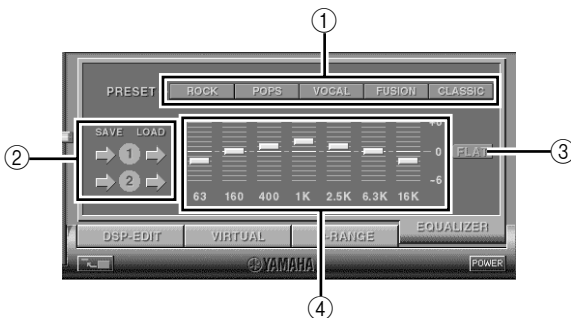

- ① **Preset patterns**
Five patterns of frequency characteristics have been preset for different types of music, such as "ROCK" and "POPS". Click a button to select the effect that suits the music type.
- ② **Storing and calling user's patterns**
You can store and call up to two patterns of frequency characteristics you specify.
- ③ **FLAT**
This makes the frequency response curves flat.
- ④ **Graphic equalizer**
The 7-band equalizer allows you to set your desired frequency response curves. By dragging the indicator for each frequency band, you can adjust the frequencies within the range of +6 to -6 dB.

Setting adjustment on the Setup panel

When you click SETUP of the Main Panel, the Setup panel appears, allowing you to perform the following settings.

Edit Names of Input Sources

You can assign a name consisting up to seven characters to each input source. For example, if a tape deck is connected to the AUX 1 terminals, you can change the name, AUX 1, to TAPE. As this name change information is sent to the main unit, the display on the main unit changes accordingly.

Volume Settings

■ USB Mix

When USB Mix is on, even if signals received at input terminal(s) other than the USB terminal when it is selected, you can mix the input signals from that selection with the signals from the computer via the USB connection and play the mixed signals. For example, while you are listening to music from the tape deck connected to AUX 1, mail arrival beeps and warning beeps are also available.

Clicking the check box to enter the check mark in the box will turn on the USB Mix. This status allows you to adjust the volume level of the signals from the USB connection. (As this adjusts the volume balance between the selected input signals and the input signals from the USB connection, it does not affect the volume when USB is selected by the input selector keys.)

Clicking the check box to delete the check mark will turn off the USB Mix. In this status, the signals from the USB connection can be played only when USB is selected by the input selector keys.

■ Maximum Volume Setting

When adjusting the volume on the Application Software, you may inadvertently turn up the volume too high. To avoid this, you can use this function to set a maximum volume for the Application Software.

■ Digital Volume Setting

This allows you to digitally turn up and down the volume in the DSP. Take care not to turn up the volume when the level of the digital input signal is high as it may cause sound distortion due to digital processing. If sound distortion occurs, turn down the volume.

USB Setting

■ USB Multi-Channel Setting (for Windows only)

This allows you to select the number of channels for sending playback signals via the USB connection from two, four, and six channels. (Note that you cannot record signals from the USB connection on the computer when six channels are selected.)

Custom Keys

■ Skin Selection

This allows you to select the skin (the design of the background picture of the Application Software) from several preset patterns.

■ Setting Remote Control Custom keys

This allows you to store a set of commands (input selector, sound field program, volume setting, etc.) to each of the **A**, **B** and **C** keys on the remote control. After storing, simply pressing each key will execute the stored command.

Note

The screen design, functions, etc. are subject to change due to software upgrades. For details, refer to the Online Help of the Application Software.

Troubleshooting

Refer to the chart below if this unit does not function properly. If the problem you are experiencing is not listed below or if the instructions given below do not help, disconnect the power cord and contact your authorized YAMAHA dealer or service center.

Problem	Cause	Remedy	
The unit cannot be turned on though the power switch is pressed.	The power cord is not plugged in or is not completely inserted.	Firmly plug in the power cord.	
No sound.	This unit is in the standby mode.	Turn on this unit by pressing the power switch on the front panel or the POWER key on the remote control.	
	Incorrect output cord connections.	Connect the cords properly. If the problem persists, the cords may be defective.	
	The muting function of this unit is on.	Turn off the muting by pressing the MUTE key.	
	Headphones are connected to the headphone jack of this unit.	Disconnect the headphones from the headphone jack to output sound from the speakers.	
	The volume is set to minimum.	Increase the volume.	
	The playback source is not selected by the input selector keys.	Select the playback source using the input selector keys.	
		When PC is selected as the input source, check that the digital or analog input is correctly selected.	
The power of the equipment selected as the input source is off.	Turn on the equipment.		
No surround effect.	The DSP is off.	Turn on the DSP.	
When making a recording from an audio CD to an MD, CD-R, etc., all tracks are recorded as one track.	A DSP sound field program is selected or the built-in graphic equalizer is used.	Turn off the DSP and the graphic equalizer.	
Program sources on an MD, CD-R, etc. which is a copy of an audio CD, cannot be recorded on the computer via the USB connection.	You cannot make a recording from a CD-R, MD, etc. which is a copy of an audio CD, to another CD-R, MD, etc. via the USB connection or the digital terminal connection.	Record the signals of such an MD, CD-R, etc. on the computer by sending the signals via an analog connection.	
Signals inputted to your computer via the USB connection cannot be recorded on the computer.	Incorrect setting of the recording device on the computer.	Correctly set the recording device on the computer. [Refer to "Recording on computer (via the USB connection)" on page 12.]	
No effect of Dolby Digital or DTS though the sound field program "VDD" is selected.	The playback source is encoded with neither Dolby Digital nor DTS.	Use a source encoded with Dolby Digital or DTS.	
Different sounds are heard together.	Sound from the computer via the USB connection may be mixed with sound from other sources because the "USB Mix" setting is set to "ON" with the Application Software.	Set the "USB Mix" setting to "OFF" if you do not want to hear mixed sounds.	
Left and right volume levels are different.	The level balance is not set to center on the "Balance" setting on the VIRTUAL panel in the Application Software.	Set the level balance to center.	

Problem	Cause	What to Do
The remote control does not work.	The batteries of the remote control are weak.	Replace the batteries with new ones.
The remote control does not function properly.	Wrong distance or angle.	The remote control will function from a maximum range of 6 meters and no more than 30 degrees off-axis from the front panel.
	Direct sunlight or strong light (of an inverter type fluorescent lamp etc.) is striking the remote control sensor of the main unit.	Reposition the main unit.

Specifications

[AP-U70]

Minimum RMS Output Power per Channel
20W + 20W (20 Hz–20 kHz, 6Ω, 0.4% THD)

Maximum Power 26W + 26W (1 kHz, 6Ω, 10% THD)

Input Sensitivity/Input Impedance
PC IN, AUX1 IN, AUX2 IN (ANALOG) 150 mV/35 kΩ

Maximum Input Signal
PC, AUX1, AUX2 2.1V or more (1 kHz)

Output Level/Output Impedance
REC OUT 150 mV/2.0 kΩ
SUBWOOFER OUTPUT 2.0V/1.7 kΩ (50 Hz)

Headphone Jack Output Level/Output Impedance
ANALOG PC IN, etc. 320 mV/61Ω (1 kHz, 150 mV)

Frequency Response
USB, DIGITAL IN (PC, AUX1) to SP Output
20 Hz–20 kHz (± 1.0 dB)

Total Harmonic Distortion (1 kHz, 20 kLPF)
USB, DIGITAL IN (PC, AUX1) to SP Output
0.06% or less (4V/6Ω)

Signal-to-Noise Ratio
USB to SP Output 85 dB or more (11V/6Ω)
PC IN, AUX1 IN (DIGITAL) to SP Output
90 dB or more (11V/6Ω)

Residual Noise (IHF-A Network)
–68 dB or less (SP Output, L/R)

Power Supply
[U.S.A. and Canada models] AC 120V, 60 Hz
[Europe and U.K. models] AC 230V, 50 Hz
[Australia model] AC 240V, 50 Hz

Power Consumption
[U.S.A. and Canada models] 60W
[Europe, U.K. and Australia models] 55W

Dimensions (W × H × D) 120 × 294 × 355 mm
(4-3/4" × 11-9/16" × 14")

Weight 5.5 kg (12 lbs. 2 oz.)

Accessories CD-ROM (Windows/Macintosh-hybrid)
USB cable
Remote control
Battery × 2

Specifications are subject to change without notice.

[DP-U50]**Output Level/Output Impedance**

PRE OUT	2.0V/2.0 k Ω
SUBWOOFER OUTPUT	2.0V/1.7 k Ω (50 Hz)

Input Sensitivity/Input Impedance

PC IN, AUX1 IN, AUX2 IN (ANALOG)	150 mV/35 k Ω
----------------------------------	----------------------

Maximum Input Signal

PC, AUX1, AUX2	2.1V or more (1 kHz)
----------------	----------------------

Headphone Jack Output Level/Output Impedance

ANALOG PC IN, etc.	320 mV/61 Ω (1 kHz, 150 mV)
--------------------	------------------------------------

Frequency Response

USB, DIGITAL IN (PC, AUX1) to PRE OUT	20 Hz–20 kHz (\pm 1.0 dB)
---------------------------------------	------------------------------

Total Harmonic Distortion (1 kHz, 20 kLPF)

USB, DIGITAL IN (PC, AUX1) to PRE OUT	0.01% or less
---------------------------------------	---------------

Signal-to-Noise Ratio

USB to PRE OUT	100 dB or more
PC IN, AUX1 IN (DIGITAL) to PRE OUT	110 dB or more

Residual Noise (IHF-A Network)20 μ V or less (PRE OUT, L/R)**Power Supply**

[U.S.A. and Canada models]	AC 120V, 60 Hz
[Europe and U.K. models]	AC 230V, 50 Hz
[Australia model]	AC 240V, 50 Hz

Power Consumption

20W

Dimensions (W \times H \times D)120 \times 294 \times 355 mm
(4-3/4" \times 11-9/16" \times 14")**Weight**

5.0 kg (11 lbs.)

AccessoriesCD-ROM (Windows/Macintosh-hybrid)
USB cable
Remote control
Battery \times 2

Specifications are subject to change without notice.



YAMAHA ELECTRONICS CORPORATION, USA 6660 ORANGETHORPE AVE., BUENA PARK, CALIF. 90620, U.S.A.
YAMAHA CANADA MUSIC LTD. 135 MILNER AVE., SCARBOROUGH, ONTARIO M1S 3R1, CANADA
YAMAHA ELECTRONIK EUROPA G.m.b.H. SIEMENSSTR, 22-34, 25462 RELLINGEN, BEI HAMBURG, F.R. OF GERMANY
YAMAHA ELECTRONIQUE FRANCE S.A. RUE AMBROISE CROIZAT BP70 CROISSY-BEAUBOURG 77312 MARNE-LA-VALLEE CEDEX02, FRANCE
YAMAHA ELECTRONICS (UK) LTD. YAMAHA HOUSE, 200 RICKMANSWORTH ROAD WATFORD, HERTS WD1 7JS, ENGLAND
YAMAHA SCANDINAVIA A.B. J A WETTERGRENS GATA 1, BOX 30053, 400 43 VASTRA FROLUNDA, SWEDEN
YAMAHA MUSIC AUSTRALIA PTY, LTD. 17-33 MARKET ST., SOUTH MELBOURNE, 3205 VIC., AUSTRALIA

YAMAHA CORPORATION

Printed in Malaysia 

V664160