

DM 2000 *Version 2* DM 2000VCM Quick Start Guide

This is a “quick start guide” designed for people about to use Yamaha DM2000 for the first time. It is not a guide to audio mixing and it assumes the reader has experience of analog mixers. It does not replace the manual; we recommend referring to the manual if further information is required.



402 pages of manual and then the editor and driver guides. Mmmm..... there has got to be a quicker way...

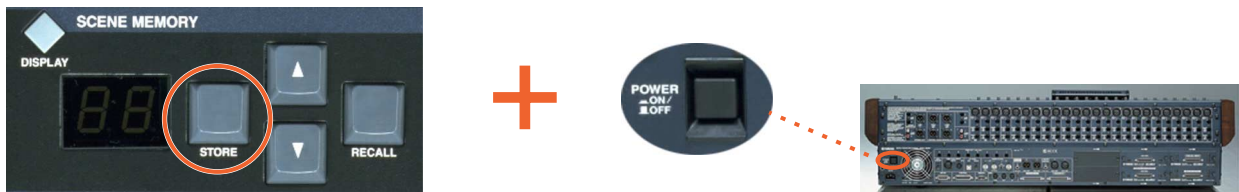

Table of contents

Table of contents	2
Getting Started with a 'blank' desk	3
Understanding the Rear Panel.....	3
Understanding the Front Panel.....	4
Controlling Channel Faders.....	5
Changing INPUT PATCH.....	6
OUTPUT PATCH	7
CHANNEL NAMES.....	8
ENCODER MODE / FADER MODE	10
Using the SELECTED CHANNEL controls.....	11
EQUALIZER.....	11
PAN.....	12
DYNAMICS	12
AUX/MATRIX SEND.....	13
ROUTING	15
PHASE / INSERT	16
DELAY	16
CHANNEL PAIR	17
FADER GROUPS	18
MUTE GROUPS	18
EFFECTS.....	19
EDITING AN EFFECT	19
USING AN EFFECT	20
ROUTING AUDIO THROUGH AN EFFECT	21
GRAPHIC EQUALIZERS	22
SCENE MEMORY	23
RECALL SAFE	23
SCENE FADE	24
SCENE COPY / PASTE	24
MONITOR.....	25
USER DEFINED KEYS	26
DM2000V2 Short-Cut List	27
Using the 'SEL' switches	27
Other Short-Cuts.....	27
Other Tips	28

Getting Started with a 'blank' desk

To erase all memories in the desk and return it to its factory settings, hold the SCENE MEMORY [STORE] button while turning on the power. (You don't need to do this if you have just unpacked the product from its box for the first time)!



To start from blank settings without erasing the memories, just recall SCENE 00. To do this, use the SCENE MEMORY Up-Arrow/Down-Arrow buttons to select Scene '00' and then press [RECALL].

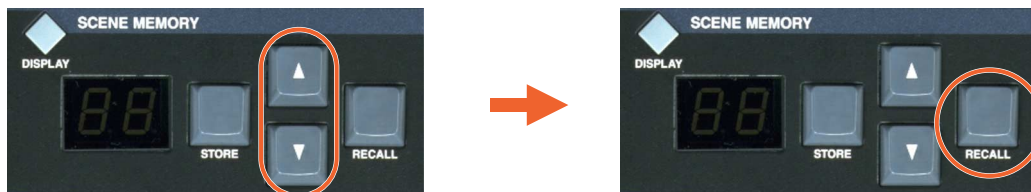

All the faders will then move down and all the mixing functions set to their default status.

Understanding the Rear Panel

All the audio connectors are on the rear panel. They include:

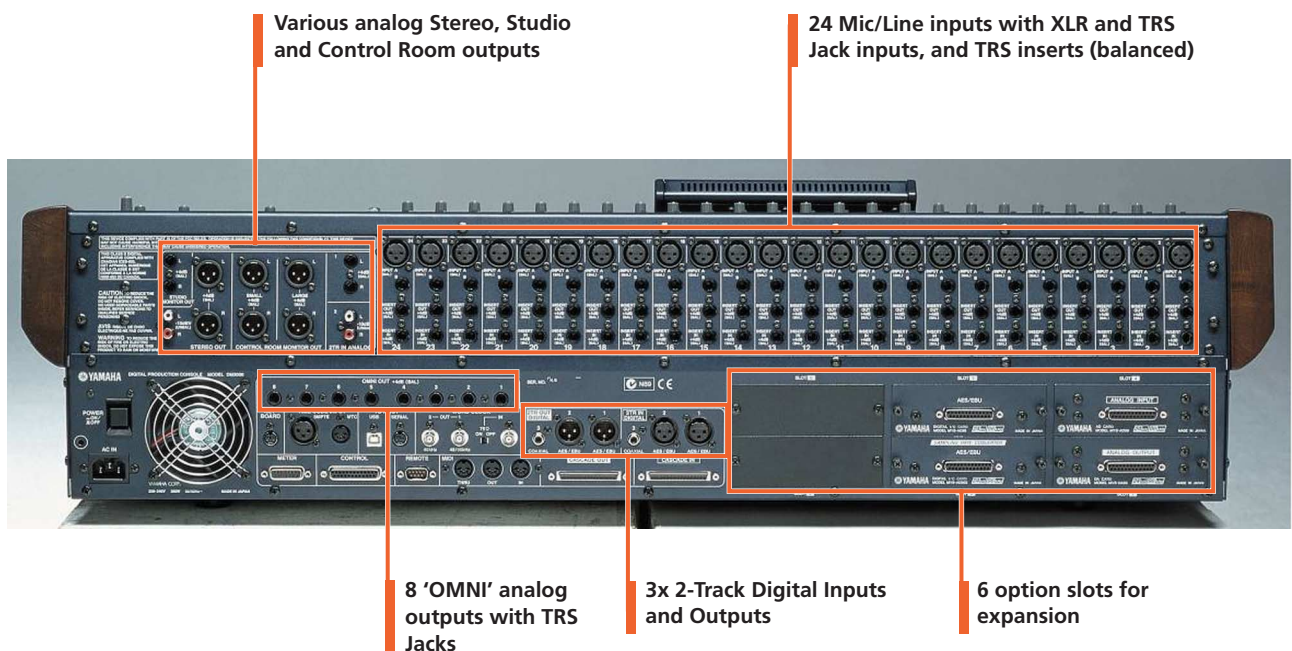

Other connectors on the rear panel are for various control and sync functions. For example, the CONTROL port (25-pin D-sub) is for GPI inputs and outputs. The CASCADE IN and OUT ports are for connecting with other DM2000 or 02R96 consoles to share audio buses. The METER connector is for the optional Meter Bridge.

Understanding the Front Panel

All the controls are on the front panel, laid out in logical areas:

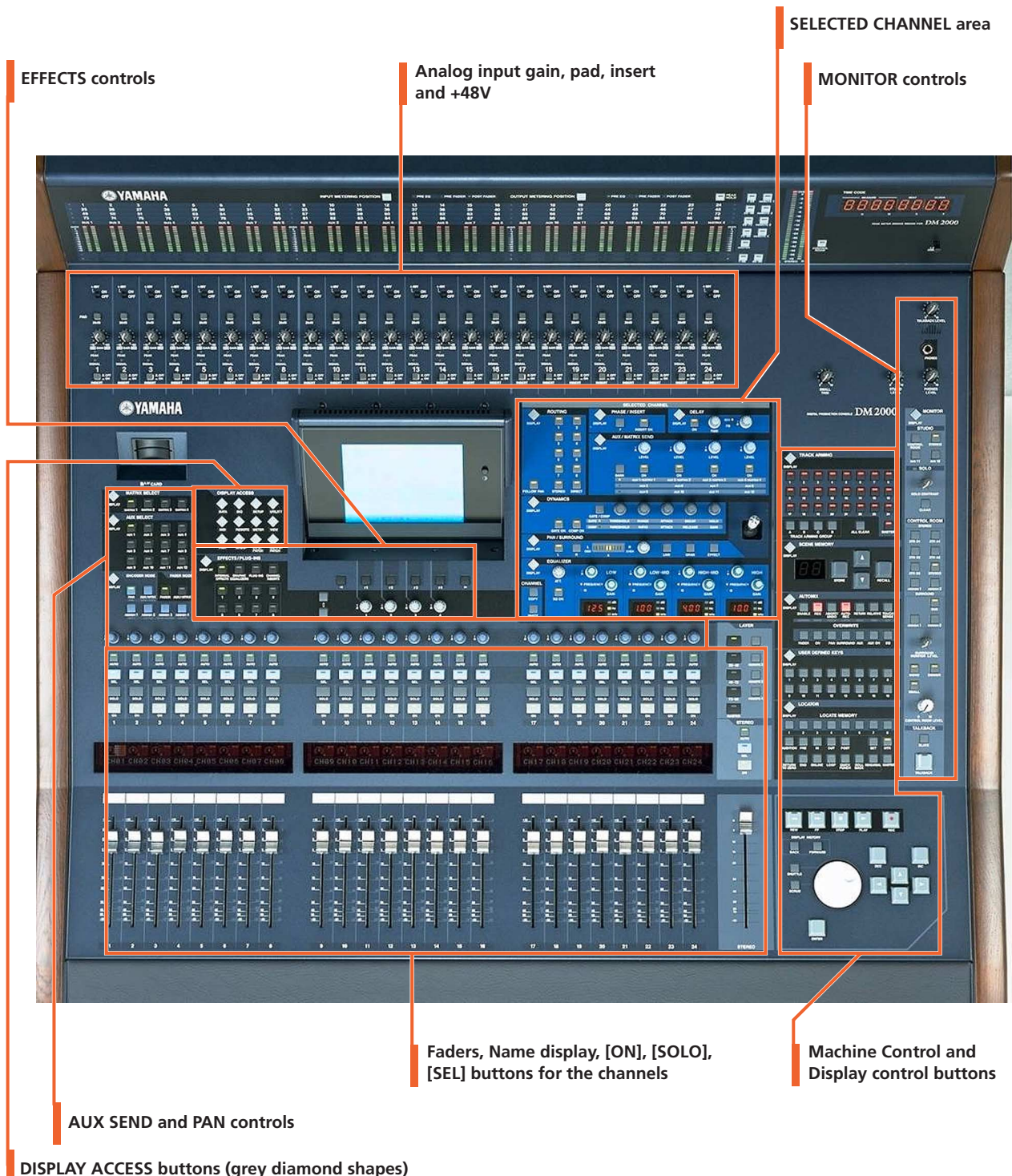

The SELECTED CHANNEL area is a fundamental concept to understand. It shows all the important functions for one channel at a time. Only one channel can be selected at any time. To select a channel (and see its settings in the SELECTED CHANNEL area), just press the [SEL] button. Then press the [SEL] button for another channel when you are ready to move on.

Controlling Channel Faders

There are 9 layers of faders on the DM2000:

When you change layers, all the channel settings are remembered. You just change which channels you are looking at!

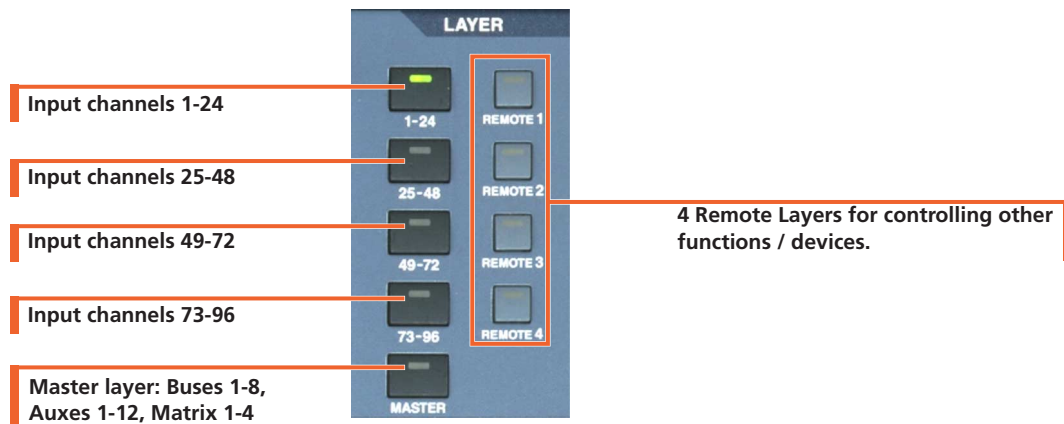

Each fader controls a different input to the DM2000. This assignment is not fixed: it can be changed in the INPUT PATCH menu.

Here is the default patch:

- channels 1-24** control the 24 analog inputs on the top on the console;
- channels 25-48** control inputs 1-8 from Slots 1, 2 and 3;
- channels 49-72** control inputs 1-8 from Slots 4, 5 and 6;
- channels 73-88** control inputs from internal Effects 1-8;
- channels 89-96** control inputs from the various 2-Trk inputs.

Changing INPUT PATCH

To assign different inputs to the input channels, such as Slot 1 inputs 9-16, follow these steps:

1. Press the [INPUT PATCH] DISPLAY ACCESS button.
2. If necessary, press it repeatedly until the CH1-48 or CH49-96 page is displayed.
3. Press [SEL] for the required channel (or move the cursor on the screen to the required channel number).
4. Press [ENTER] (by the data wheel at the bottom right corner of the console). This will open the PATCH SELECT window.
5. Select the type of input from the first list in the PATCH SELECT window (AD in / Slot in / FX out and so on).
6. Press [ENTER] and choose the required item from the next column (Slot # or FX # for example).
7. Press [ENTER] and choose the required item from the last column (CH# or L/R for example).
8. Press [ENTER] and click YES on the PATCH SELECT window to complete the Patch change.

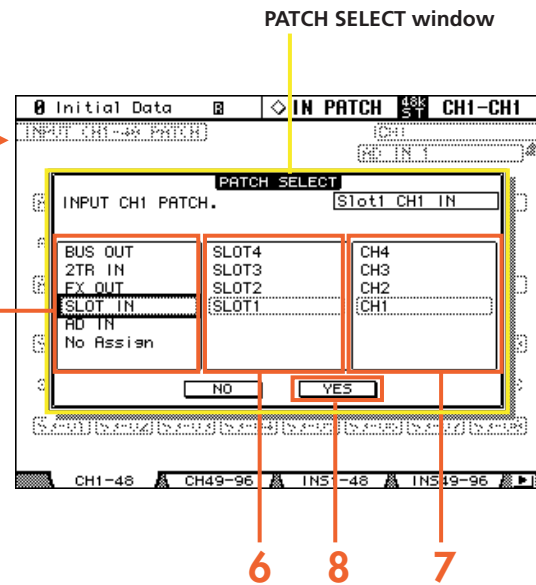
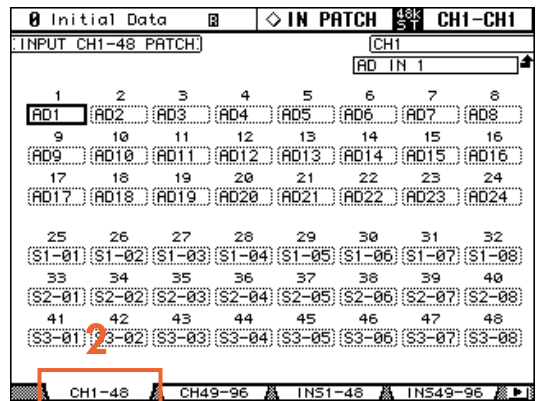
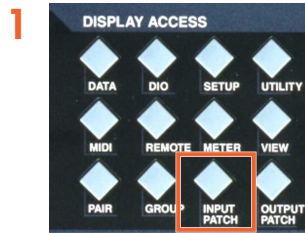

OUTPUT PATCH

The STEREO output channel is the only one to have a dedicated output on the rear panel of DM2000. All other output channels must be assigned to one (or more) of the OMNI outputs or SLOT outputs. This can be performed in the [OUTPUT PATCH] menu.

The default patch of DM2000 includes AUX1-8 assigned to OMNI 1-8, and BUS1-8 assigned to each SLOT output 1-8 respectively.

To edit the Output Patch, press the [OUTPUT PATCH] DISPLAY ACCESS button (and press it again if necessary) to view the required SLOT or OMNI page.

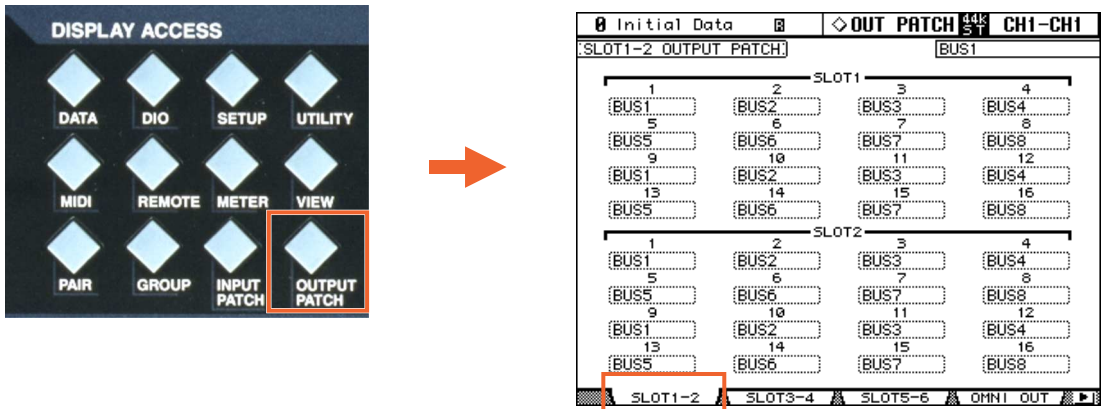

Use the cursor keys to highlight the required output port, and press [ENTER] to open the PATCH SELECT window. Then choose the type of channel and channel number, and click [ENTER] on the YES box to complete the patch.

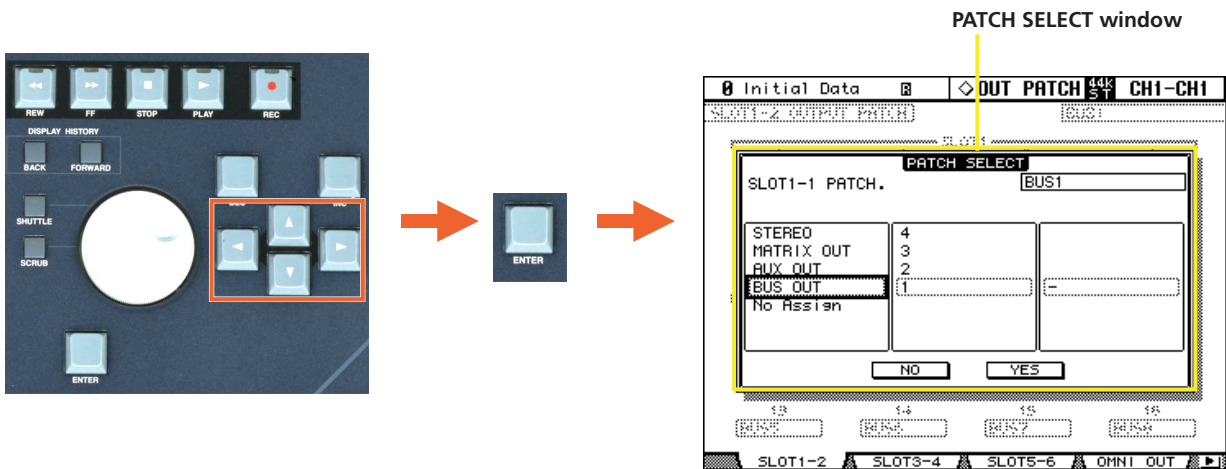

Once all the patch editing is complete, it is a good idea to save the settings into the Patch Library. There are separate INPUT PATCH and OUTPUT PATCH libraries, accessed from the relevant DISPLAY ACCESS buttons. There are 32 memories in each Patch Library.

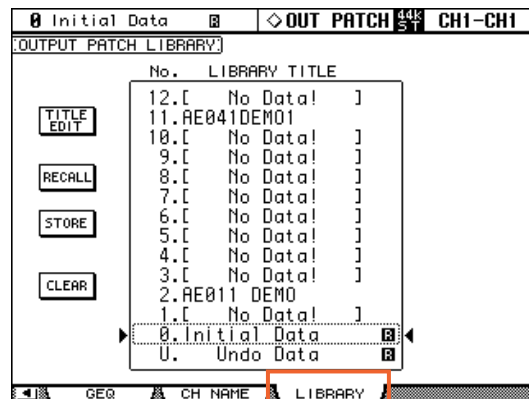

CHANNEL NAMES

Each channel on the DM2000 can be given a name, which is displayed in the fluorescent window (①) above the faders. Also the name of the currently selected channel is always displayed in the top-right corner of the LCD.



To input a channel name, first access the CH NAME page by pressing the [INPUT PATCH] DISPLAY ACCESS button.

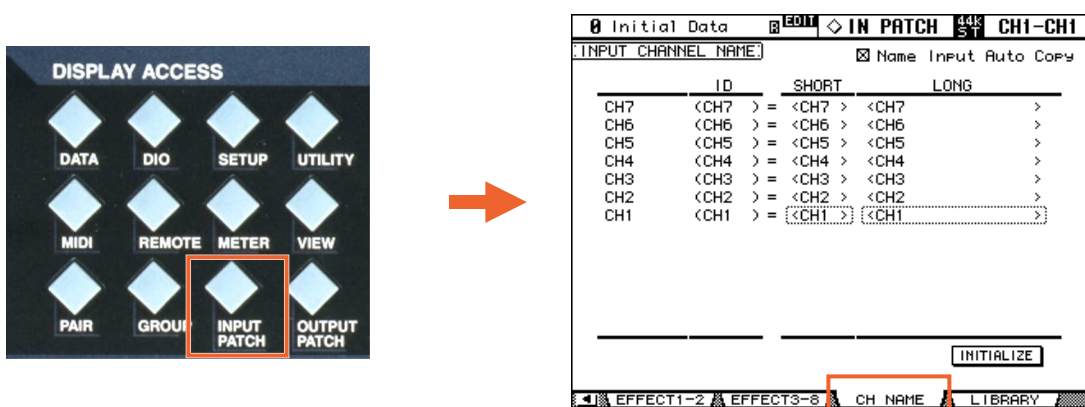

Then press the [SEL] button for the required channel, and press [ENTER] to display the TITLE EDIT window on the LCD. If a computer keyboard is connected to the rear panel, then a name can be typed. Otherwise, use the cursor keys and [ENTER] button to navigate around the LCD keyboard.

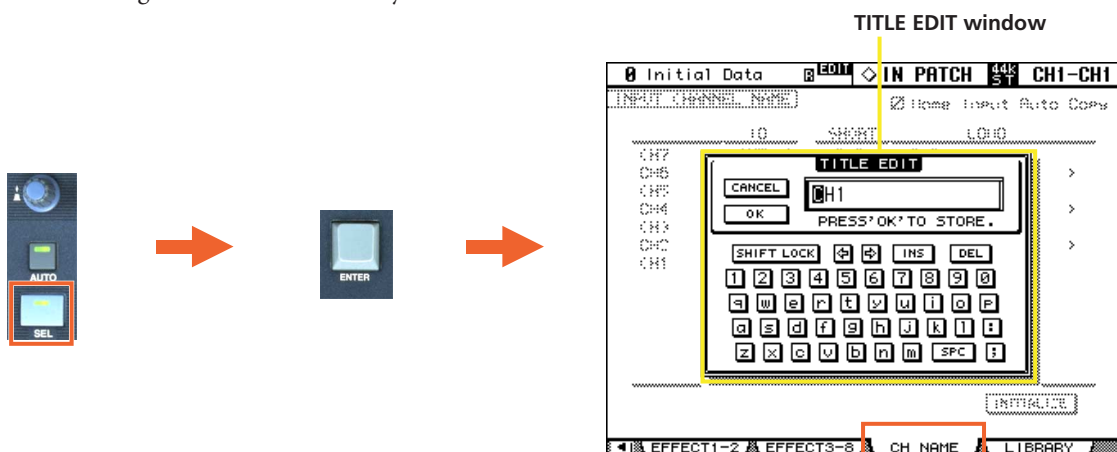

Note that there are long (16 character) and short (4 character) names for each channel. The short name appears in the fluorescent window above the faders, and the long name is just for reference. Check the [Name Input Auto Copy] option at the top of the CH NAME page to automatically copy the first 4 characters of the long name to the short name whenever a new long name is entered.

To enter names for the Buses, Auxes and Matrix channels, look in the [OUTPUT PATCH] menu.

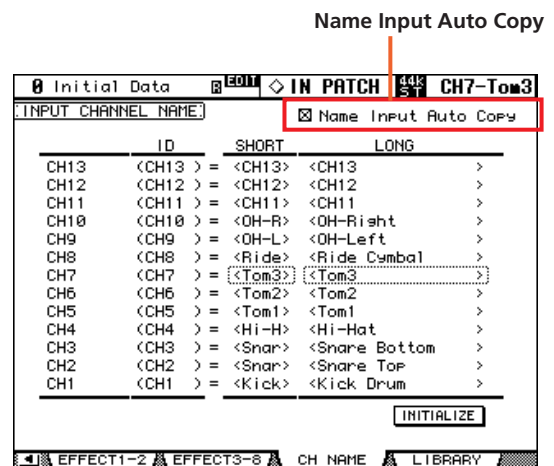

TIP: To briefly view a channel's long name while a different page is displayed on the LCD, just hold the channel's [SEL] button for a second or more, and the long name will show in the fluorescent window above the faders.

ENCODER MODE / FADER MODE

The encoders above the faders can be used to edit various channel parameters. The most useful ones are PAN and AUX SEND.

To see the Aux send information for many channels at the same time, press the AUX SELECT [DISPLAY] button. Each time this button is pressed, it will change the LCD to a different page to see the information for other channels. In these pages PRE/POST status can be edited, and the AUX SENDS can be turned off by pressing [ENTER] while the cursor is high-lighting the Level encoder.

To edit AUX on the encoders, press the [AUX/MTRX] ENCODER MODE button, then select the required AUX# (1-12) with one of the [AUX#] SELECT buttons above. The Aux level will be displayed in the fluorescent window above the channel faders.

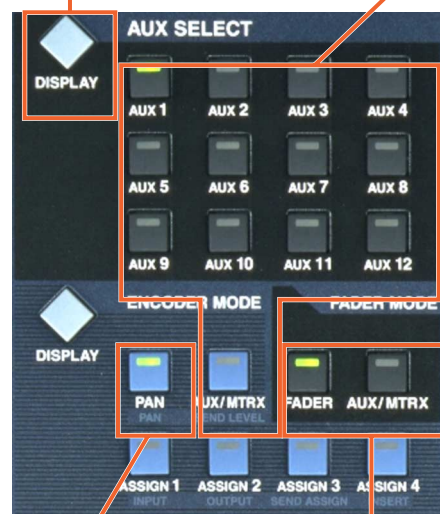

To edit PAN on the encoders, just press the [PAN] ENCODER MODE button and turn the required encoder. The pan position will be displayed in the fluorescent window above the channel faders.

When the [AUX/MTRX] FADER MODE button is pressed, the AUX SEND levels are shown on the faders instead of the channel level. Choose which Aux to see on the faders with the [AUX#] SELECT buttons (as in step 2 above). Press the [FADER] FADER MODE button to resume normal level operation on the faders.

Using the SELECTED CHANNEL controls

When a channel is selected, its settings can be seen and controlled in the SELECTED CHANNEL area. The currently selected channel's name and number is always shown in the top-right corner of the LCD screen.

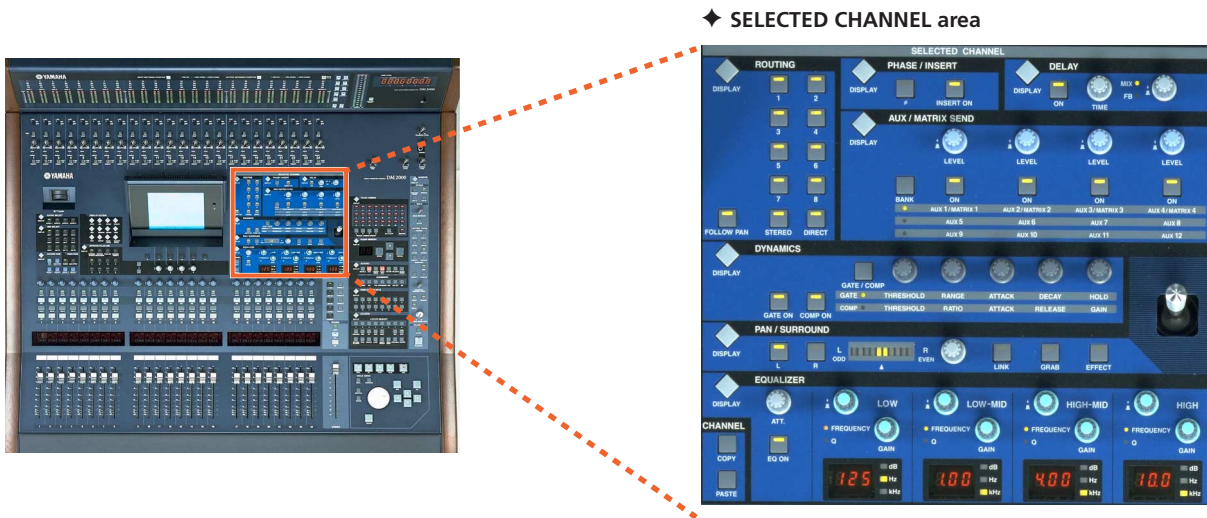

◆ EQUALIZER

When one of the EQ controls is moved, the LCD will show the EQ edit page. There are 4 parametric bands. To change between controlling FREQUENCY and Q, press down quickly on the encoder. Note that the LOW band can be a Low Shelf or a HPF by changing the Q to the maximum or minimum position. In the same way, the HIGH band can be a High Shelf or a LPF. There are 2 types of EQ (TYPE I or TYPE II), with slightly different sound characteristics. The ATT function is an attenuator, or digital trim to adjust the channel level pre-eq.

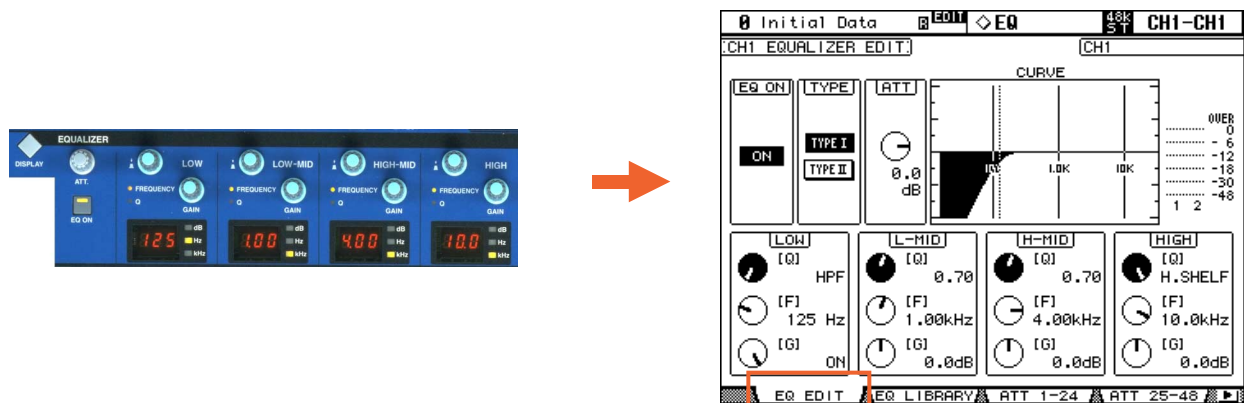

◆ PAN

The PAN and SURROUND PAN settings of the selected input channel can be edited here (Output channels do not have PAN). The L and R buttons show if the channel is the Left or Right side of a stereo pair. The Joystick is not active until a SURROUND MODE is selected. To do this, press the PAN/SURROUND [DISPLAY] button so the SURR MODE page is shown. Then choose the SURROUND MODE: 3-1 or 5.1 or 6.1. This will then convert some of the Buses (1-8) into Surround Buses.

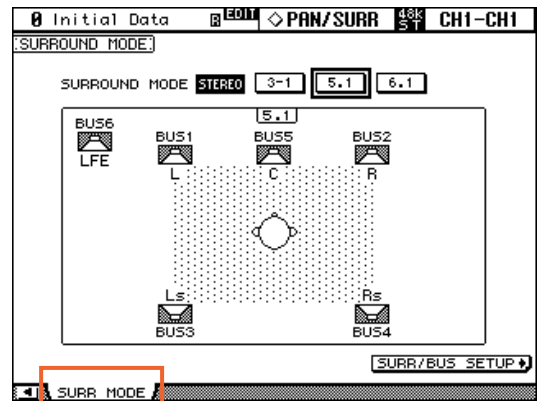
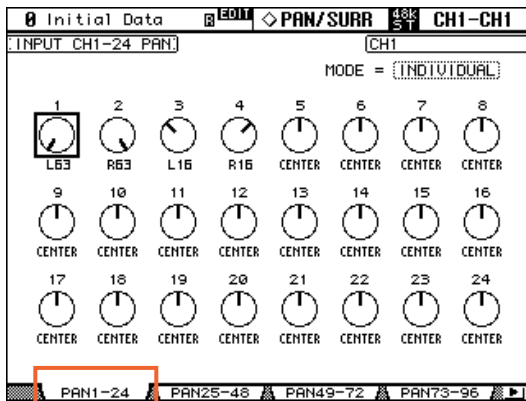

◆ DYNAMICS

Each input channel has both a GATE and a COMP. The output channels only have a COMP. When a [DYNAMICS] button or encoder is moved, the LCD shows the relevant GATE or COMP page. Gain Reduction meters and Key-In status can also be viewed here. Usefully, the COMP can be positioned pre-eq, pre-fader (post-eq) or post-fader.

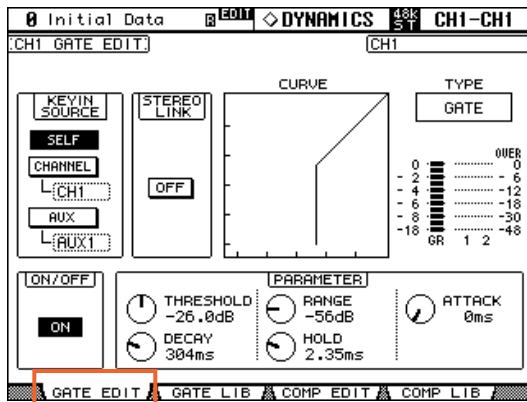

or

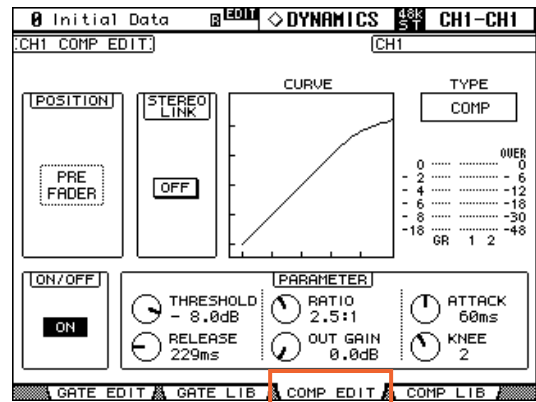

◆ AUX/MATRIX SEND

Each input channel has 12 Aux Sends, and each Bus and Aux channel has 4 Matrix Sends. In this section the LEVEL and ON status can be adjusted. Use the [BANK] switch to access the required Aux Send control for the selected input channel: 1-4; 5-8; 9-12.

Even when the AUX or MATRIX menu is not shown on the LCD, the Send Level will always 'pop-up' on the LCD whenever it is adjusted or when the encoder is simply pressed.

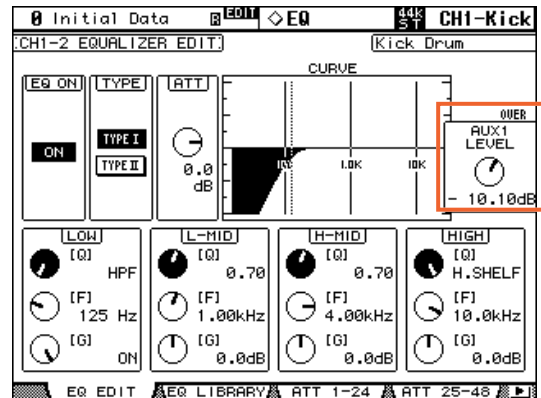

Press the AUX/MATRIX SEND [DISPLAY] button to see the relevant information on the LCD. Use the [AUX#] and [MATRIX#] SELECT buttons on the left side of the DM2000 to choose which Aux or Matrix number to view. Pressing the [DISPLAY] button repeatedly will access LEVEL and PRE/POST settings for all the channels. The VIEW pages show all the Aux or Matrix Sends for each fader layer in a bar-graph format.

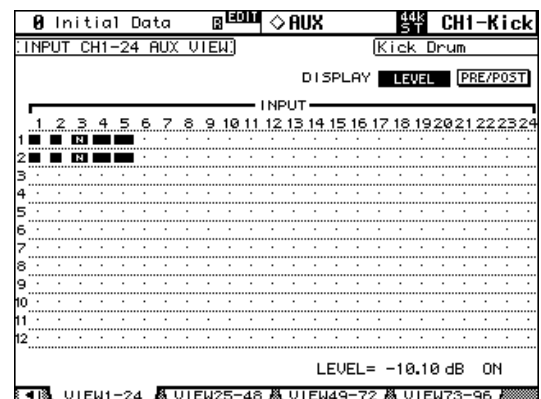
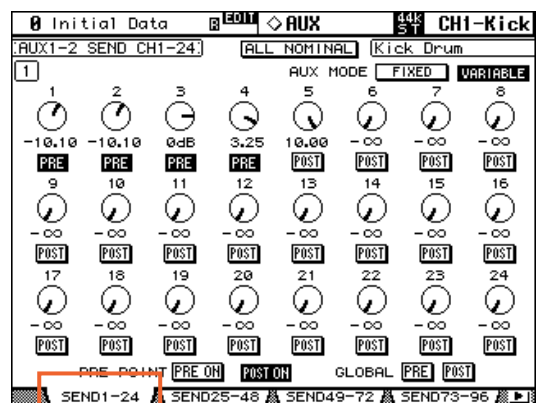

PAN controls can also be accessed for any stereo-paired Aux and for the Matrix sends (which are always stereo). These parameters must be edited with the Data Wheel and Cursor Keys in the bottom-right corner of the DM2000.

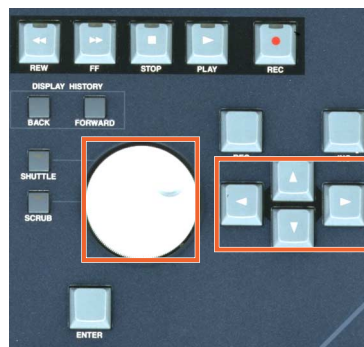
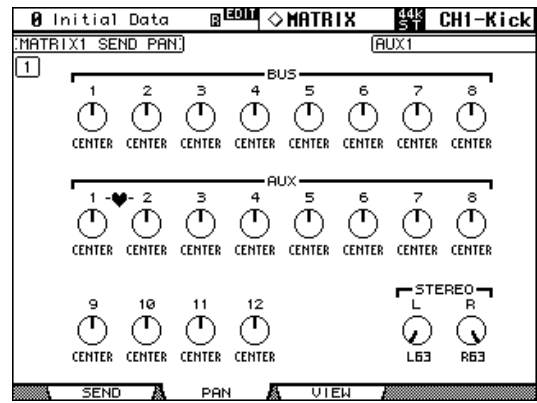
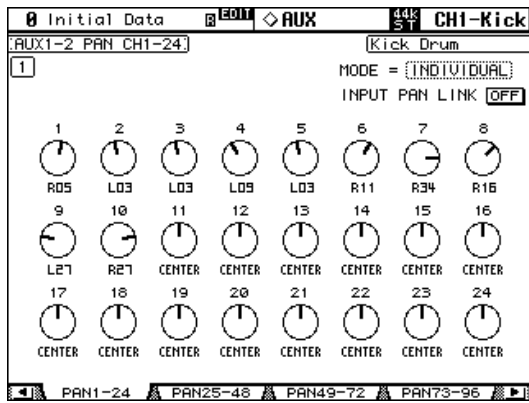

◆ ROUTING

In this section, the Selected Channel can be routed to any of the 8 Buses, to the Stereo Bus and to a Direct Output. Just press the relevant button to route the channel to the Bus (these buttons are not available for Output Channels). The [FOLLOW PAN] button ensures that the PAN of the channel will follow through to the Buses. This is particularly useful when using the Buses as stereo Sub-Groups (as on a typical analog console). The Bus assignment is also displayed in the fluorescent window above the channel faders.

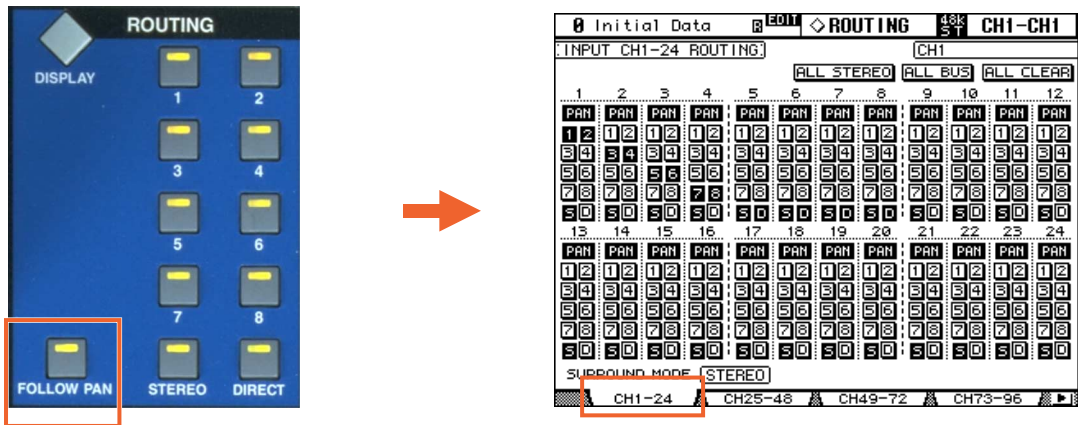

Buses can be routed to Stereo (just like Sub-Groups on an analog console). To do this, press the ROUTING [DISPLAY] button to see the BUS TO ST page. Here Buses 1-8 can be routed, panned and mixed to the Stereo Bus. Use the cursor keys, data wheel and [ENTER] button to adjust the parameters.

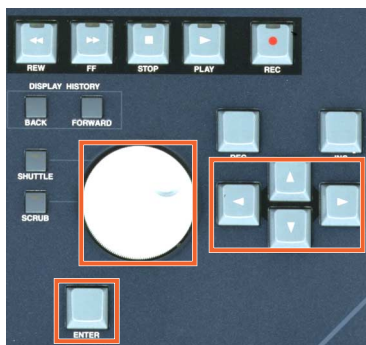
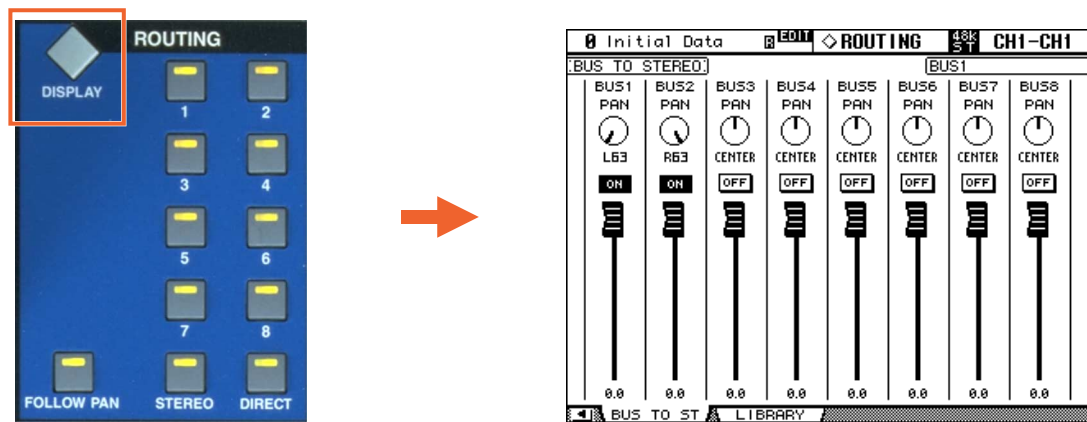

◆ PHASE / INSERT

Press the PHASE/INSERT [DISPLAY] button to see Phase and Insert information on the LCD. Phase Reverse is only available for input channels. Insert is available for all channels. Inserts need to be patched, choosing which rear-panel connection (or internal Effect) to use for INSERT OUT and INSERT IN. The INSERT POSITION can also be changed here.

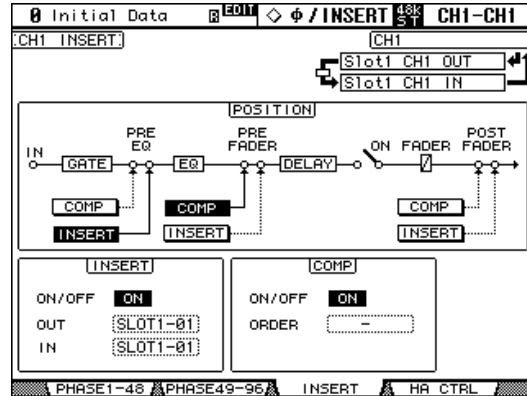

◆ DELAY

Press the DELAY [DISPLAY] button to see Delay settings for each channel. All input and output channels have a Delay function. The maximum possible Delay Time varies with sample rate. At 44.1KHz, the maximum possible Delay Time is 984.1ms. Input channels have an FB.GAIN (Feedback Gain) and MIX parameter to create a simple Delay effect. The DELAY SCALE can be changed to see the Delay Time in equivalent distance, number of samples, beats-per-minute or number of Frames (linked to Time-Code Frame Rate).

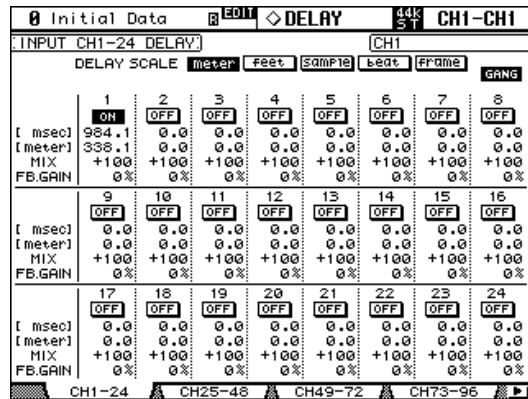

CHANNEL PAIR

If some Stereo input sources are used, such as a Synthesizer or CD player, it could be useful to pair the relevant channels together. There are two modes for pairing channels, as selected in the [PAIR] menu.

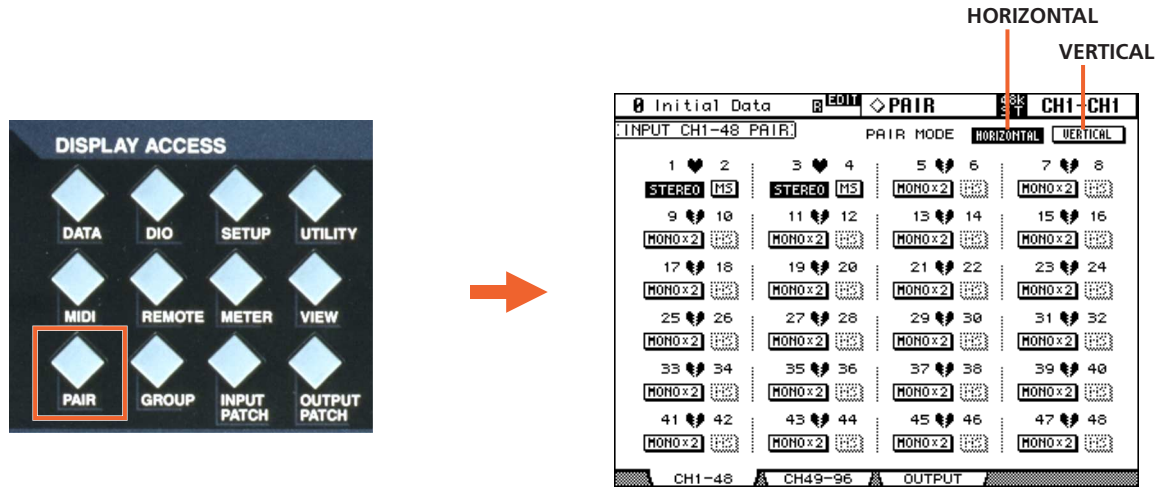

Horizontal mode allows odd numbered channels to be paired with their adjacent even numbered channel.

Vertical mode allows channels on the top fader layer (1-24) to be paired with the equivalent channel on the layer below (25-48). In the same way, channels 49-72 can be paired vertically with channels 73-96 respectively, but the Master channels can only be paired Horizontally.

When channels are paired, they share the same fader level, the same ON, EQ, Gate, Comp, Aux settings. Pan and Routing parameters remain separate.

To quickly pair channels without using the LCD screen, first **1** hold down the [SEL] button for the Left channel, then **2** also hold down the [SEL] button for the Right channel (or vice versa) for half a second. This only works in Horizontal Pair Mode.



FADER GROUPS

Fader Groups are useful for controlling many faders by just moving one fader. There are 8 Fader Groups available for input channels and 4 Fader Groups for output channels.

Here is how to link faders together in a Group:

1. Access the [GROUP] displays on the LCD.

2. Choose a Group (A to H for inputs, Q to T for outputs) using the Cursor buttons (bottom right of the console).

3. Press the [SEL] buttons for the required channels to include them in the Group.

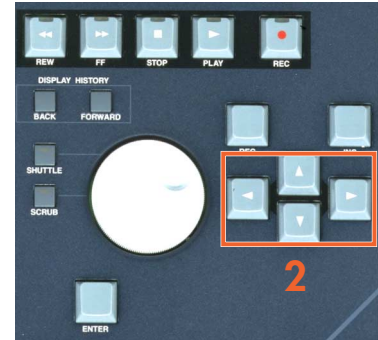
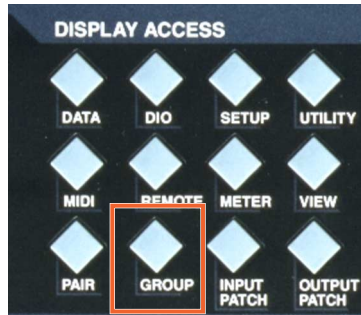

Initial Data		GROUP	44k	CH8-CH8
[INPUT CH1-48 FADER GROUP] [] INPUT FADER MASTER				
A	1 2 3 4 5 6 7 8 9 10 11 12 13 14 15 16 17 18 19 20 21 22 23 24			ENABLE MASTER
B			0dB
C			0dB
D			0dB
E			0dB
F			0dB
G			0dB
H			0dB
25262728 29303132 33343536 37383940 41424344 45464748				
A				ENABLE MASTER
B			0dB
C			0dB
D			0dB
E			0dB
F			0dB
G			0dB
H			0dB
FADER1-48 FADER49-96 MUTE1-48 MUTE49-96				

Now, when one fader in the Group is moved, all the others move by the same amount. If one fader in the Group needs to be moved without the others, then hold that channel's [SEL] button while pushing the fader (but not while the GROUP page is displayed, or that channel will be removed from the Group).

NOTE: Channels cannot be in more than one Fader Group at the same time.

MUTE GROUPS

Mute Groups are useful for turning On/Off many channels by just pressing one button. There are 8 Mute Groups available for input channels and 4 Mute Groups for output channels. To assign channels to a Mute Group, follow the same 3 steps as made for a Fader Group, but while viewing the MUTE GROUP pages (Groups I to P are for Inputs, Groups U to X are for Outputs).

Once a Mute Group is made, when the ON button for one channel is pressed, all the other channels in the same Group are also turned On/Off.

EFFECTS

There are 8 Multi-Effects Units inside DM2000. They can be viewed on the LCD by pressing the [INTERNAL EFFECTS] button, and then pressing one of the buttons [1-8] below to select the required unit.

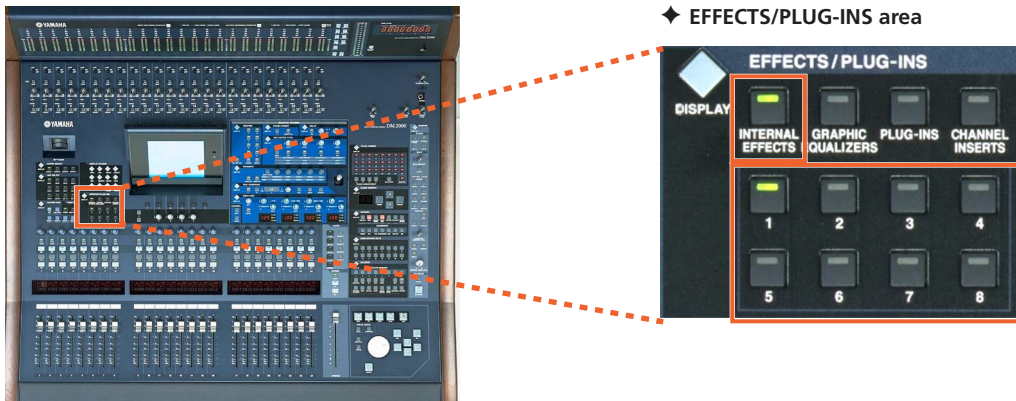

◆ EDITING AN EFFECT

The Effect parameters can be edited using the 4 encoders below the LCD. Use the Up/Down arrow buttons next to these encoders to move to the other rows of parameters when an effect has more than 4 parameters to edit.

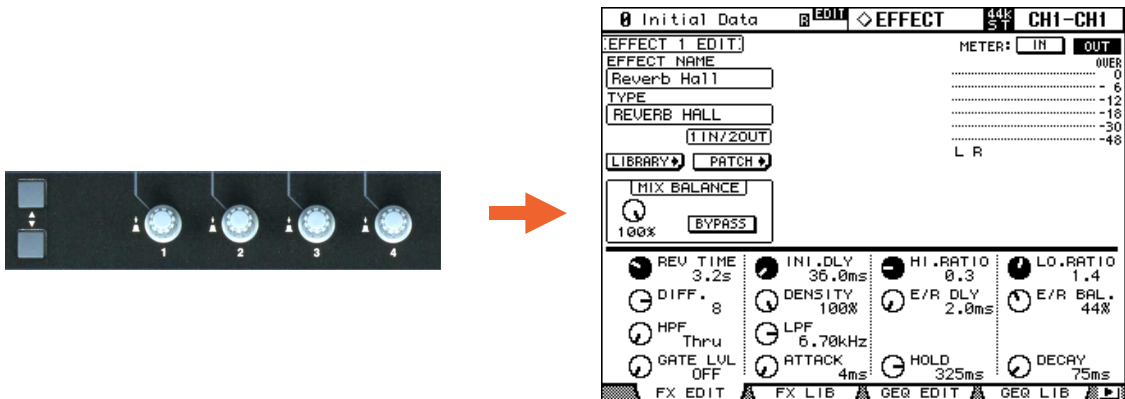

To change the type of effect (from Reverb to Delay for example), press the EFFECTS/PLUG-INS [DISPLAY] button to see the FX LIBRARY. Then scroll through the list with the data wheel, and press [ENTER] with the cursor over the RECALL button on the left of the screen.

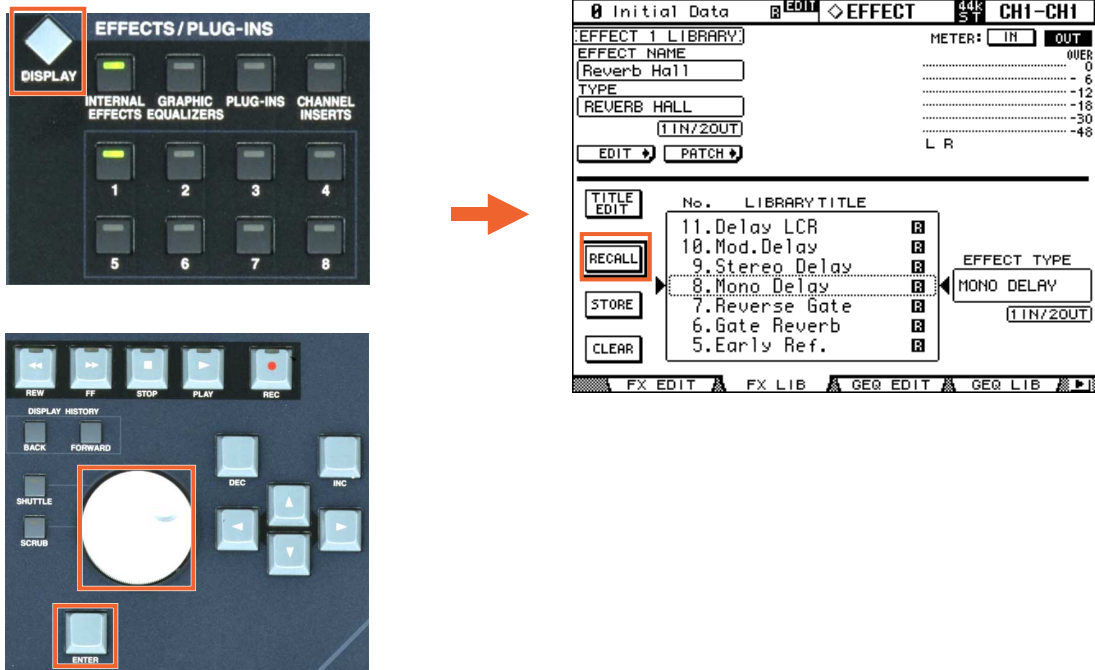

◆ USING AN EFFECT

Before an effect can be used properly, it needs to be patched. The default patch (factory setting) has Aux 1-8 patched to the inputs of FX1-8 respectively. The stereo outputs of FX1-8 are patched to input channels 73-88 respectively. This is convenient, but can be changed if necessary. For example, an effect could be inserted in just one channel using the INSERT OUT and IN patch. To change the FX patching, go to the EFFECT1-2 or EFFECT3-8 pages in the INPUT PATCH display menu.

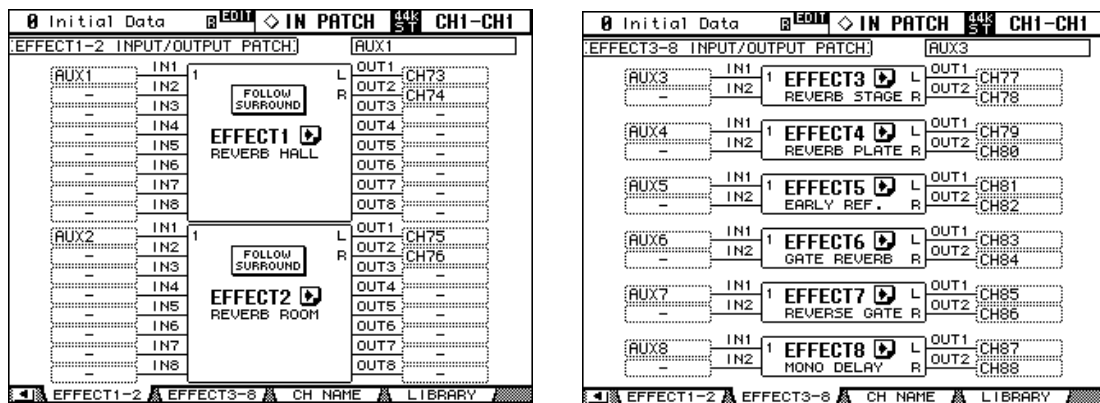

NOTE: Only Effects 1 and 2 are capable of using Surround (5.1) effects.

ROUTING AUDIO THROUGH AN EFFECT

1. First, audio needs to be routed into the effect. If the default patch is used, first turn up Aux 1 send level for the required channel.
2. Check that the Aux 1 Master fader is up to 0dB (that is its default position).
3. Already audio should be seen on the level meters of Effect 1. You can see the meters on the top-right corner of the FX EDIT page.
4. Then push up faders 73 and 74 to start hearing the effect's output in the Stereo bus.

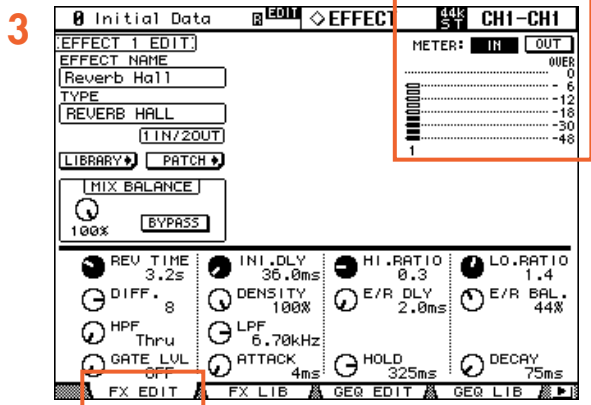
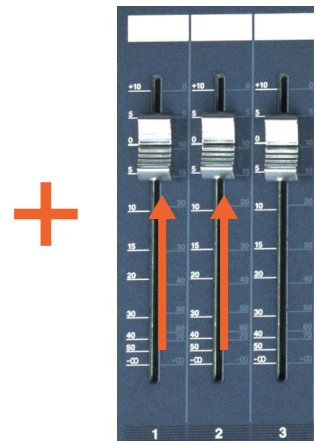
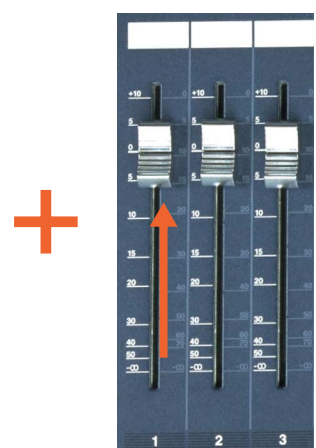

GRAPHIC EQUALIZERS

DM2000 provides 6 Graphic Equalizers for use with any Bus, Aux, Matrix or Stereo Master channel. To access the GEQ functions, press the [GRAPHIC EQUALIZERS] button in the EFFECTS/PLUG-INS section and then select one of the 6 GEQs by pressing one of the numbered buttons below.

Move the cursor to the INSERT area of the page, and press [ENTER] to select which channel to insert the GEQ into. The GEQ is always inserted post fader, and is separate from the standard insert point which can be used for internal (or external) Effects.

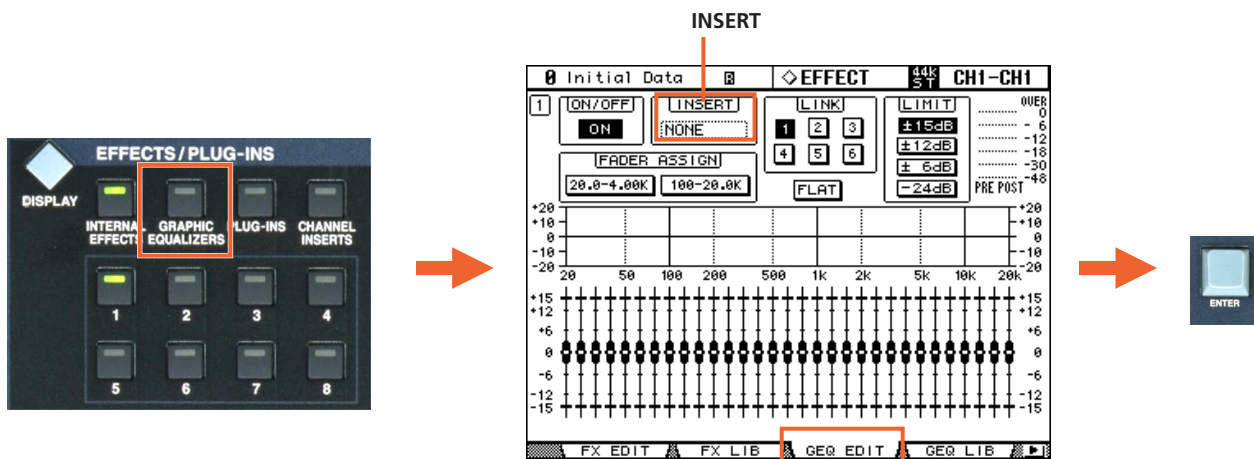

The channel faders can be used to edit the GEQ bands by moving the cursor onto one of the FADER ASSIGN buttons, and pressing [ENTER].

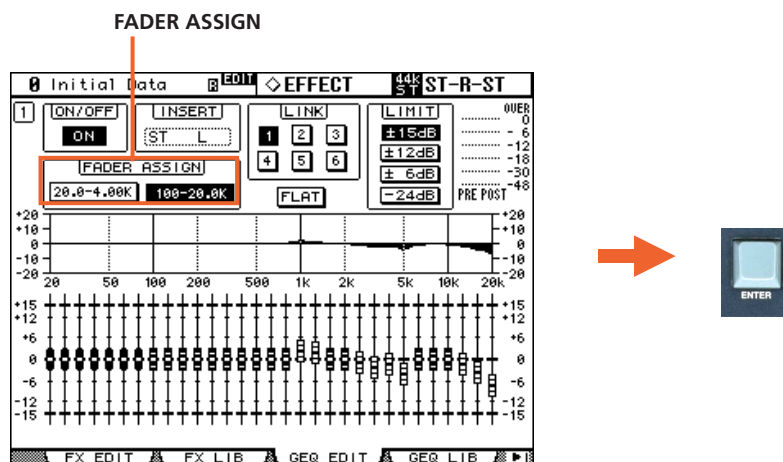

The fluorescent display above the channel faders indicates which frequency is being adjusted by each fader, and while a fader is being adjusted, the gain value is displayed. When the page shown on the LCD is changed, the channel faders will return to their normal function so mixing can continue.

NOTE: The GEQs can only be edited on the faders while the GEQ EDIT page is displayed.

SCENE MEMORY

There are 99 SCENE MEMORIES available in DM2000. Each Scene stores all the mixing parameters, including all input channel, output channel and Effects parameter data.



The SCENE MEMORY list can be seen by pressing the SCENE MEMORY [DISPLAY] button.

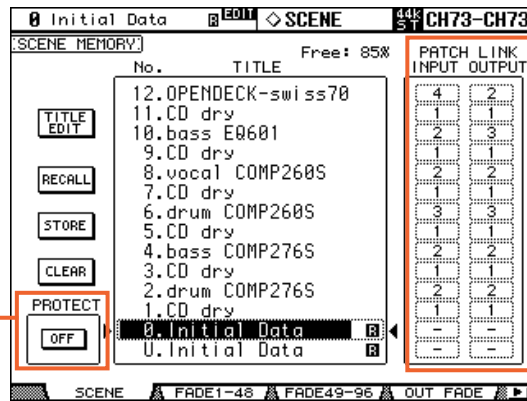

When a SCENE is stored, a name can be entered. If a SCENE is PROTECTED, it cannot be overwritten when STORE is pressed. This avoids erasing something by mistake.

The PATCH LINK feature can be useful if different Scenes need different Patch settings. Patch information is not stored in the scenes, but is stored in the INPUT PATCH and OUTPUT PATCH libraries (accessed from the relevant DISPLAY ACCESS buttons). Then the Patch libraries can be linked to the Scenes so they are recalled at the same time as the scene.

◆ RECALL SAFE

In this page, choose which parameters will not be overwritten when recalling a Scene. When the Global Recall Safe box is checked (at the top of the screen), the chosen parameters will be safe in all Scenes. Otherwise, these settings will only apply to the current Scene once it is stored.

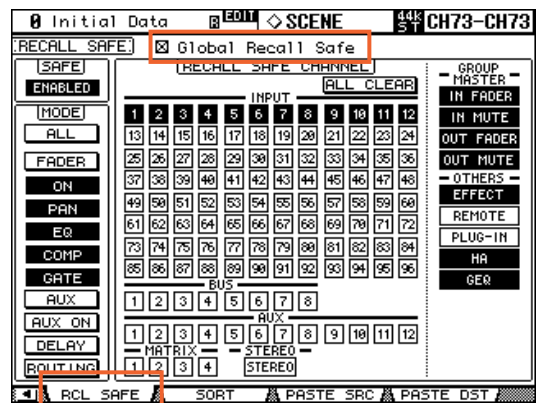

◆ SCENE FADE

Normally when a Scene is recalled, the Faders move instantly to their stored position. Using the Fade Time function, the faders can be programmed to move slowly, taking up to 30 seconds to complete their movement. Checking the Global Fade Time box will give the same Fade Time to every Scene. After setting the Fade Time for one channel, double-click the [ENTER] button to copy the time to all Input or Output Channels.

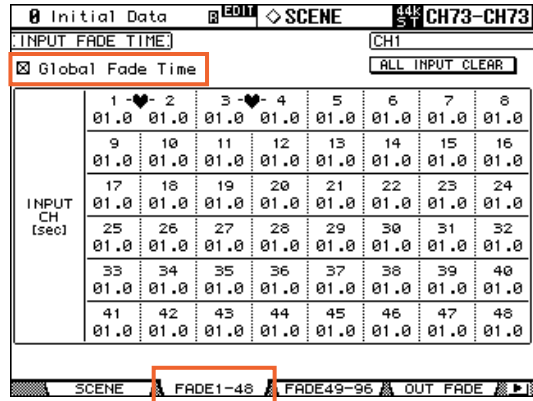

◆ SCENE COPY / PASTE

If some settings need to be copied from one Scene to some others, the PATSE SRC and PASTE DST pages can be used.

In the PASTE SRC page, choose which parameters of which channels should be copied.

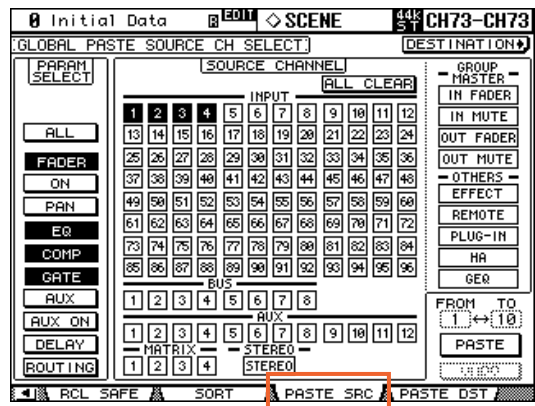

In the PASTE DST page, choose which Scene Memories should be updated. The maximum number is 10 Scenes for each operation.

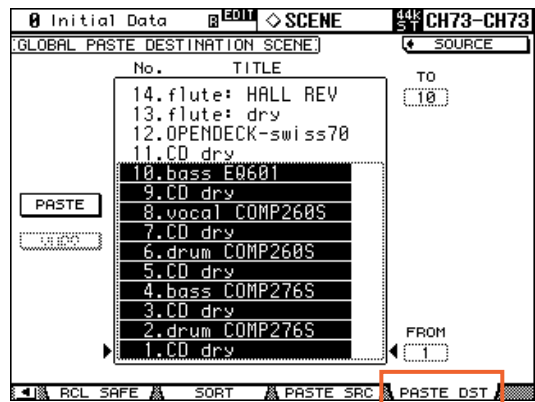

To move a Scene to a different position in the Library, use the SORT page in the SCENE MEMORY menu:

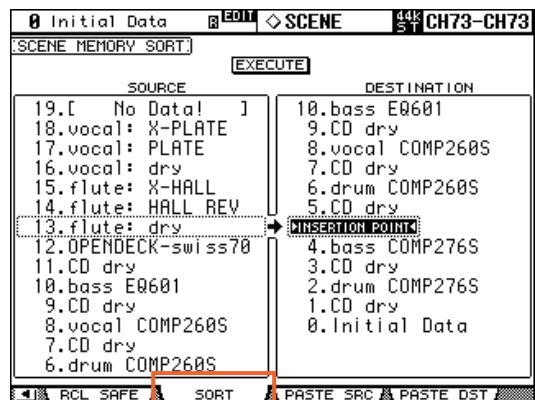

MONITOR

In this section of the console, the operator chooses what to listen to, and controls the listening level.

1. The [CONTROL ROOM LEVEL] adjusts the main listening level. The [DIMMER] button can quickly dim the speakers by 20dB or so.
2. The CONTROL ROOM buttons select what to listen to in the Control Room monitors (and in the headphones).
3. The STUDIO buttons select what to listen to in the Studio monitors. Pressing the [CONTROL ROOM] button will route the Control Room signal also to the Studio.
4. The SOLO [CLEAR] button will turn off the SOLO function for all channels. The [SOLO CONTRAST] function allows the whole mix to still be heard in the background whilst soloing particular channels.
5. The MONITOR [DISPLAY] button accesses the many extra monitor functions on the LCD.

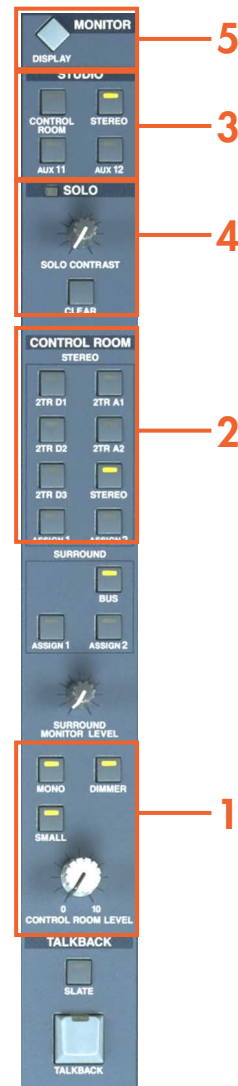

There is a small TALKBACK microphone built in to the top right corner of the console, and it has a level controller. The [TALKBACK] on/off button is located directly below the CONTROL ROOM LEVEL pot. To route TALKBACK to different outputs, access the TALKBACK page in the MONITOR menu:

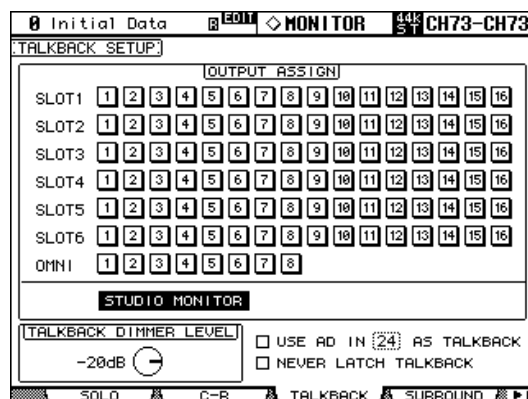

USER DEFINED KEYS

There are 16 buttons that can be programmed by the user to provide various short-cuts and other useful functions. Pressing the USER DEFINED KEYS [DISPLAY] button will show the available functions on the LCD.

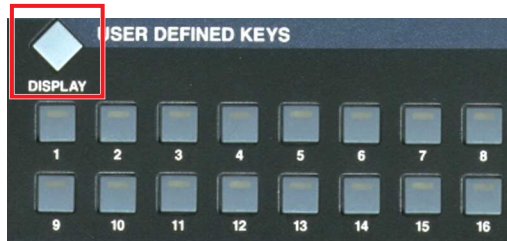

There are 8 Banks of functions for the buttons. Either choose the most appropriate Bank for the required purpose, or define the function assigned to each button individually. Each Bank is given a Title to describe its general purpose.

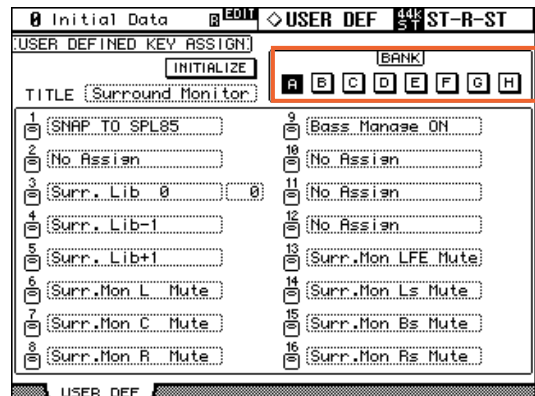

To assign a new function to a USER DEFINED KEY, first move the cursor to the relevant field in the USER DEF page. Then press [ENTER] to open the USER DEFINE SELECT window. The general function should be selected in the first column, followed by the specific function in the second and third columns (if applicable).

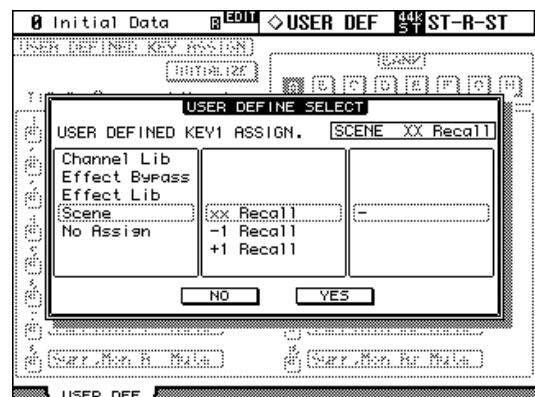

In some cases, for example a direct Scene recall (xx Recall), the specific number (Scene Memory number in this case) will need to be selected by using the silver Data Wheel and [ENTER] key.

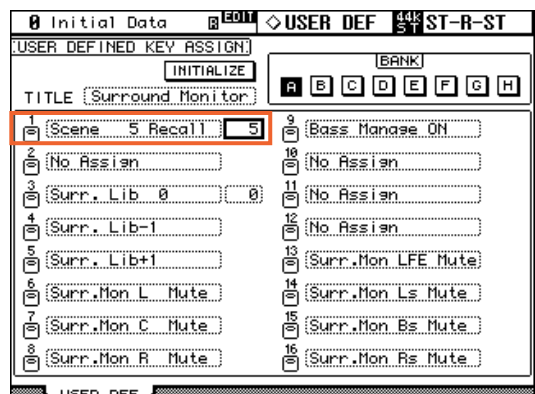

See the 'Other Tips' section below for more information about USER DEFINED KEYS.

DM2000V2 Short-Cut List

Using the 'SEL' switches

1. CHANNEL PAIR

Hold [SEL] for one channel and press [SEL] for the adjacent channel to make a stereo pair. This works for input and output channels, so long as the left side is an odd number and the right side is an even number. The channel with the [SEL] button you hold first is the master channel for the pair: its settings are copied to the other channel (except for pan and bus routing settings). Repeating this action breaks the stereo pair, to make the channels mono again.

2. CHANNEL NAME DISPLAY

To view the long name for a channel, press and hold its [SEL] button for more than a second. The name will be displayed in the fluorescent window above the faders.

3. CHANNEL COPY

Select the source channel with its [SEL] button, then press the [CHANNEL COPY] button (in the SELECTED CHANNEL area). Then press the [SEL] button of the destination channel and press [PASTE].

NOTE: The parameters which are copied are determined on the PREFERENCES 2 page in the SETUP menu.

Other Short-Cuts

1. EQ Gain to 0dB

To reset the gain of an EQ band to 0dB, press and hold the [FREQUENCY/Q] encoder for one second.

2. EQ Reset

To return the whole Parametric EQ for a channel to its default settings, press the [FREQUENCY/Q] encoders for the LOW and HIGH bands at the same time.

3. AUX ON/OFF

To access the AUX ON/OFF buttons quickly, press and hold the required [AUX# SELECT] button. Then the [ON] buttons above the faders become the AUX ON buttons for the selected Aux.

TIP: This can be useful for creating a MIX-MINUS. First set an AUX to ALL NOMINAL, using the button at the top of the SEND1-24 page in the AUX DISPLAY menu, then hold the AUX SELECT button to switch off the send for the required 'minus' channel.

4. AUX SOLO

To solo an AUX MASTER while still viewing an INPUT FADER LAYER, press the required [AUX# SELECT] button once to select it, and once again to SOLO it. Pressing a third time will cancel the SOLO. While the AUX is in SOLO, its SELECT button will flash.

NOTE: This function can be disabled in the SOLO page of the MONITOR menu, with the AUX/SOLO LINK option.

5. Copy STEREO Mix to an AUX

Press and hold an INPUT FADER LAYER button, then press an [AUX# SELECT] button, and click YES in the confirmation box on the LCD. This copies the fader levels to the selected AUX sends. Make sure the Aux sends are all PRE by clicking the [GLOBAL PRE] button on the SEND1-24 page in the AUX DISPLAY menu.

NOTE: Repeat the same procedure for each fader layer to copy the whole mix to the Aux sends, as only one layer is copied at a time.

TIP: This is useful for making a quick headphone mix in a recording session (where AUX 11 and 12 can be sent directly to the STUDIO MONITOR OUT), or making a quick stage-monitor mix for a guest musician at a live performance.

6. GEQ edit on Faders

In the GEQ EDIT page (EFFECTS/PLUG-INS menu), click one of the [FADER ASSIGN] buttons to access the GEQ bands on the faders. When you navigate away from this page, the faders return to their normal mode, but the cursor position is remembered, so next time the GEQ EDIT page is accessed, you only need to press [ENTER] to get fader control.

7. SCENE FADE TIME Copy

To assign the same fade time to all channels in a scene, first enter the required FADE TIME for one channel, then double-click [ENTER] to copy the time to all the other input or output channels.

Other Tips

1. GROUP ASSIGN

The default settings of USER DEFINED KEY bank F is for INPUT GROUP ASSIGN functions. Keys 1-8 are for Input FADER GROUPS, and Keys 9-16 are for Input MUTE GROUPS. To assign a channel to a group, select the channel and press the relevant USER DEFINED KEY in BANK F. The USER DEFINED KEY will then light up to confirm the assignment.

NOTE: A Channel cannot be in more than one FADER GROUP at a time, and cannot be in more than one MUTE GROUP at a time.

2. DCA Faders

To have DCA (or analog VCA) style Fader Masters, first check the [INPUT FADER MASTER] box near the top of the FADER GROUP display page. Then choose one of the 4 REMOTE FADER LAYERS (by pressing the [REMOTE] DISPLAY ACCESS button, and select USER ASSIGNABLE LAYER as the TARGET. After that, all the GROUP MASTER FADERS can be selected to appear on chosen REMOTE LAYER, along with any other channels selected by the user.

3. MUTE MASTER Switches

USER DEFINED KEY bank G, by default, consists of the twelve MUTE GROUP MASTER switches. But first the INPUT MUTE MASTER and OUTPUT MUTE MASTER boxes must be checked in the GROUP display menu.

4. Remote Control of AD824 or AD8HR Units

To remote control the Head-Amp settings of these units. Select HA as the REMOTE FUNCTION in the REMOTE page of the SETUP menu. Then select which slots are used for which units (the Unit ID is displayed on the front panel of the remote AD units). Assign one of the ENCODER MODE [ASSIGN#] buttons to HA Gain so the input Gain can be controlled from the Channel Encoders. PHANTOM POWER can be controlled from the HA CTRL page in the PHASE/INSERT menu.

5. SCENE MEMORY Auto Update

In the PREFERENCES1 page of the SETUP menu, the Scene MEM Auto Update option can be found. When this is switched on, the last mixing settings are memorized just before the next Scene is recalled.

Then when a previous Scene is recalled, its last settings are recalled first. Press RECALL again to access the original scene settings. So two memories for each scene are kept: the original settings, and the last settings.

6. Return to Current Scene

When scrolling through the SCENE MEMORY list, it is easy to forget which is the current Scene. To return to displaying the current Scene, press both SCENE [UP] and [DOWN] buttons simultaneously.

7. USER DEFINED KEYS

Here are some suggested uses for these keys, apart from the defaults:

- Scene +1/-1 Recall: to recall the next or the previous Scene.
- OSC On/Off: to control the internal Oscillator.
- Talkback Assign: to choose the talkback destination.
- FL CH/Port: alternate between seeing the channel name and the input port name in the FL display above the faders.
- Studio Manager: open and close various windows in the DM2000 editor on PC or Mac.

8. Initialize Memories

To erase all the memories in the console and return it to its initial settings, first switch off the console. Then switch it on again while holding the SCENE [STORE] button. Choose INITIALIZE to erase all the libraries and return to the default settings.

Check for the latest downloads at
www.yamahaproaudio.com