

YAMAHA AX-570/470

Natural Sound Stereo Integrated Amplifier

100W + 100W (8Ω) RMS Output Power, 0.015% THD, 20–20,000 Hz <AX-570>

65W + 65W (8Ω) RMS Output Power, 0.015% THD, 20–20,000 Hz <AX-470>

High Dynamic Power, Low Impedance Drive Capability

Continuously Variable Loudness Control

PURE DIRECT Switch to Reproduce the Purest Source Sound

SUBSONIC FILTER Switch to Cut Out Undesirable Ultra-Low-Frequency Signals <For AX-570 only>

PRE OUT/MAIN IN Terminals Useful for Connecting An Equalizer, Sound Processor, etc. <For AX-570 only>

Remote Control Capability

Thank you for selecting this YAMAHA stereo integrated amplifier.



OWNER'S MANUAL

CONTENTS

Safety Instructions	2
Supplied Accessories	3
Connections	4
Operations	6
Remote Control Transmitter ...	10
Notes about the Remote Control Transmitter	11
Troubleshooting	12
Specifications	13

IMPORTANT!

Please record the serial number of this unit in the space below.

Model:
Serial No.:

The serial number is located on the rear of the unit.
Retain this Owner's Manual in a safe place for future reference.

WARNING

TO REDUCE THE RISK OF FIRE OR ELECTRIC SHOCK, DO NOT EXPOSE THIS UNIT TO RAIN OR MOISTURE.

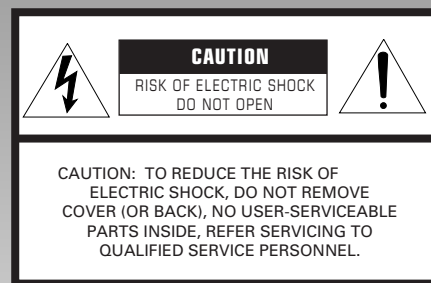

• Explanation of Graphical Symbols



The lightning flash with arrowhead symbol, within an equilateral triangle, is intended to alert you to the presence of uninsulated "dangerous voltage" within the product's enclosure that may be of sufficient magnitude to constitute a risk of electric shock to persons.



The exclamation point within an equilateral triangle is intended to alert you to the presence of important operating and maintenance (servicing) instructions in the literature accompanying the appliance.

SAFETY INSTRUCTIONS

- 1 Read Instructions – All the safety and operating instructions should be read before the unit is operated.
- 2 Retain Instructions – The safety and operating instructions should be retained for future reference.
- 3 Heed Warnings – All warnings on the unit and in the operating instructions should be adhered to.
- 4 Follow Instructions – All operating and other instructions should be followed.
- 5 Water and Moisture – The unit should not be used near water – for example, near a bathtub, washbowl, kitchen sink, laundry tub, in a wet basement, or near a swimming pool, etc.
- 6 Carts and Stands – The unit should be used only with a cart or stand that is recommended by the manufacturer.
- 6A A unit and cart combination should be moved with care. Quick stops, excessive force, and uneven surfaces may cause the unit and cart combination to overturn. 
- 7 Wall or Ceiling Mounting – The unit should be mounted to a wall or ceiling only as recommended by the manufacturer.
- 8 Ventilation – The unit should be situated so that its location or position does not interfere with its proper ventilation. For example, the unit should not be situated on a bed, sofa, rug, or similar surface, that may block the ventilation openings; or placed in a built-in installation, such as a bookcase or cabinet that may impede the flow of air through the ventilation openings.
- 9 Heat – The unit should be situated away from heat sources such as radiators, stoves, or other appliances that produce heat.
- 10 Power Sources – The unit should be connected to a power supply only of the type described in the operating instructions or as marked on the unit.
- 11 Power-Cord Protection – Power-supply cords should be routed so that they are not likely to be walked on or pinched by items placed upon or against them, paying particular attention to cords at plugs, convenience receptacles, and the point where they exit from the unit.
- 12 Cleaning – The unit should be cleaned only as recommended by the manufacturer.
- 13 Nonuse Periods – The power cord of the unit should be unplugged from the outlet when left unused for a long period of time.
- 14 Object and Liquid Entry – Care should be taken so that objects do not fall into and liquids are not spilled into the inside of the unit.
- 15 Damage Requiring Service – The unit should be serviced by qualified service personnel when:
 - A. The power-supply cord or the plug has been damaged; or
 - B. Objects have fallen, or liquid has been spilled into the unit; or
 - C. The unit has been exposed to rain; or
 - D. The unit does not appear to operate normally or exhibits a marked change in performance; or
 - E. The unit has been dropped, or the cabinet damaged.
- 16 Servicing – The user should not attempt to service the unit beyond those means described in the operating instructions. All other servicing should be referred to qualified service personnel.
- 17 Power Lines – An outdoor antenna should be located away from power lines.
- 18 Grounding or Polarization – Precautions should be taken so that the grounding or polarization is not defeated.

Caution: Read this before operating your unit

- 1 To ensure the finest performance, please read this manual carefully. Keep it in a safe place for future reference.
- 2 Install your unit in a cool, dry, clean place – away from windows, heat sources, and too much vibration, dust, moisture or cold. Avoid sources of hum (transformers, motors). To prevent fire or electrical shock, do not expose to rain and water.
- 3 Do not operate the unit upside-down. It may overheat, possibly causing damage.
- 4 Never open the cabinet. If a foreign object drops into the set, contact your dealer.
- 5 Do not use force on switches, knobs or cords. When moving the set, first turn the unit off. Then gently disconnect the power plug and the cords connecting to other equipment. Never pull the cord itself.
- 6 Do not attempt to clean the unit with chemical solvents; this might damage the finish. Use a clean, dry cloth.
- 7 Always set the volume control to “– ∞” before starting the audio source play: increase the volume gradually to an appropriate level after the play is started.
- 8 To prevent lightning damage, pull out the power cord and remove the antenna cable during an electrical storm.
- 9 **When not planning to use this unit for long periods of time (ie., vacation, etc.), disconnect the AC power plug from the wall outlet.**
- 10 Be sure to read the “Troubleshooting” section on common operating errors before concluding that your unit is faulty.
- 11 Do not connect audio equipment to the AC outlets on the rear panel if that equipment requires more power than the outlets are rated to provide.

FCC INFORMATION

1. IMPORTANT NOTICE : DO NOT MODIFY THIS UNIT!

This product, when installed as indicated in the instructions contained in this manual, meets FCC requirements. Modifications not expressly approved by Yamaha may void your authority, granted by the FCC, to use the product.

2. IMPORTANT :

When connecting this product to accessories and/or another product use only high quality shielded cables. Cable/s supplied with this product MUST be used. Follow all installation instructions. Failure to follow instructions could void your FCC authorization to use this product in the USA.

3. NOTE :

This product has been tested and found to comply with the requirements listed in FCC Regulations, Part 15 for Class "B" digital devices. Compliance with these requirements provides a reasonable level of assurance that your use of this product in a residential environment will not result in harmful interference with other electronic devices.

This equipment generates/uses radio frequencies and, if not installed and used according to the instructions found in the users manual, may cause interference harmful to the operation of other electronic devices.

Compliance with FCC regulations does not guarantee that interference will not occur in all installations. If this product is found to be the source of interference, which can be determined by turning the unit "OFF" and "ON", please try to eliminate the problem by using one of the following measures:

Relocate either this product or the device that is being affected by the interference.

Utilize power outlets that are on different branch (circuit breaker or fuse) circuits or install AC line filter/s.

In the case of radio or TV interference, relocate/reorient the antenna. If the antenna lead-in is 300 ohm ribbon lead, change the lead-in to coaxial type cable.

If these corrective measures do not produce satisfactory results, please contact the local retailer authorized to distribute this type of product. If you can not locate the appropriate retailer, please contact Yamaha Electronics Corp., U.S.A. 6660 Orangethorpe Ave, Buena Park, CA 90620.

The above statements apply ONLY to those products distributed by Yamaha Corporation of America or its subsidiaries.

We Want You Listening For A Lifetime

YAMAHA and the Electronic Industries Association's Consumer Electronics Group want you to get the most out of your equipment by playing it at a safe level. One that lets the sound come through loud and clear without annoying blaring or distortion – and, most importantly, without affecting your sensitive hearing. Since hearing damage from loud sounds is often undetectable until it is too late, YAMAHA and the Electronic Industries Association's Consumer Electronics Group recommend you to avoid prolonged exposure from excessive volume levels.



SUPPLIED ACCESSORIES

After unpacking, check that the following parts are contained.

- Remote Control Transmitter

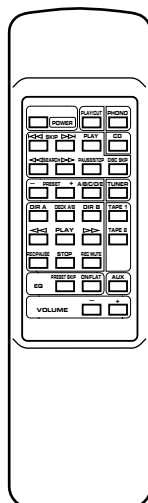

- Batteries (size AA, R6, UM-3)

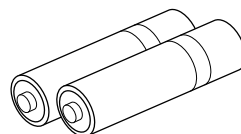

CONNECTIONS

- Before attempting to make any connections to or from this unit, be sure to first switch OFF the power to this unit and to any other components to which connections are being made.
- When making connections between this unit and other components, be sure all connections are made correctly, that is to say L (left) to L, R (right) to R, "+" to "+" and "-" to "-". Also, refer to the owner's manual for each component to be connected to this unit.

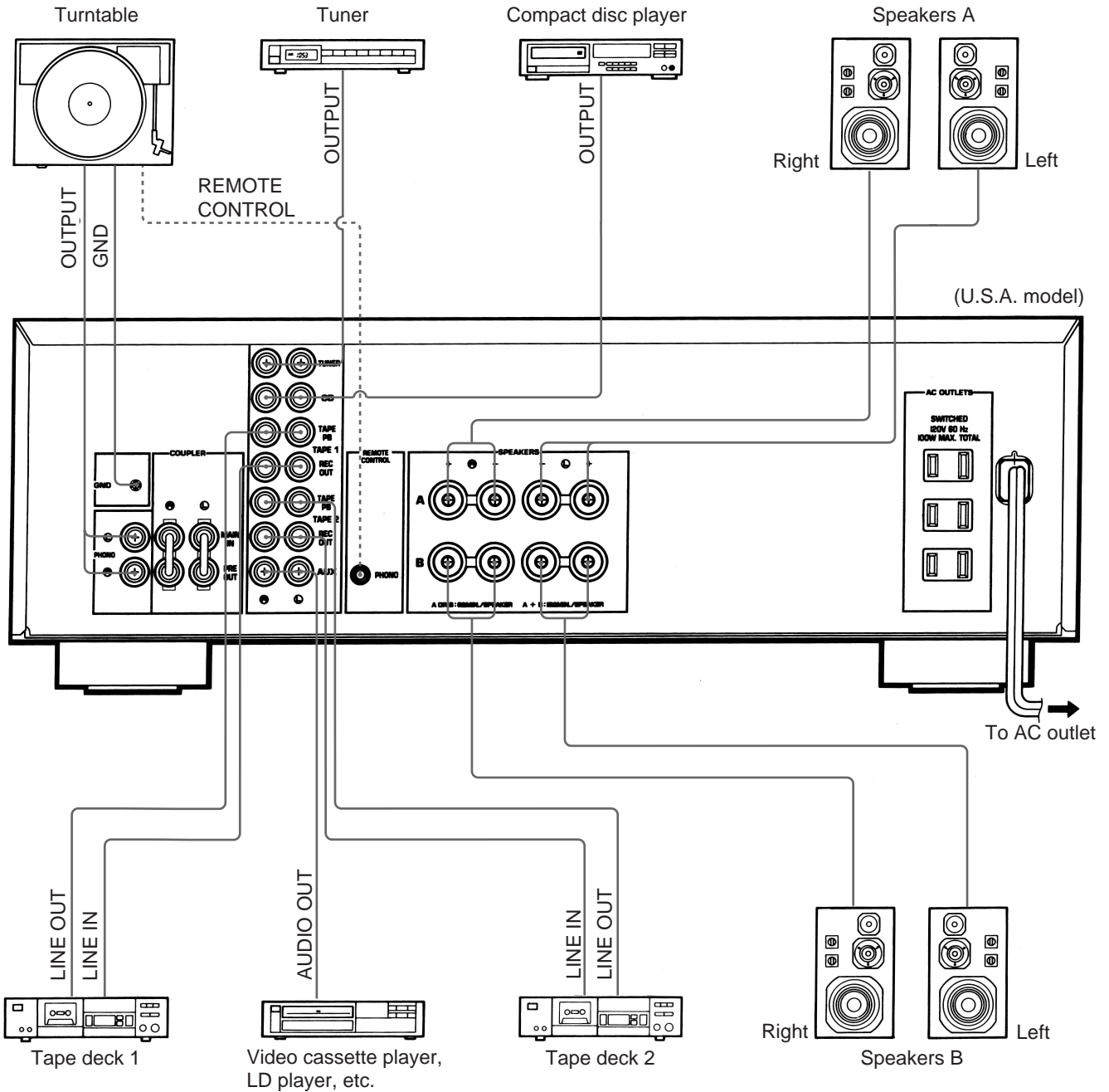

Illustration: AX-570
 Parts in shaded area () are not present on AX-470.

CONNECTING SPEAKERS

Connect the **SPEAKERS** terminals to your speakers with wire of the proper gauge, cut as short as possible. If the connections are faulty, no sound will be heard from the speakers. Make sure that the polarity of the speaker wires is correct, that is, + and – markings are observed. If these wires are reversed, the sound will be unnatural and will lack bass. **Do not let the bare speaker wires touch each other and do not let them touch the metal parts of this unit as this could damage this unit and/or speakers.**

How to Connect:

Red: positive (+)
Black: negative (-)

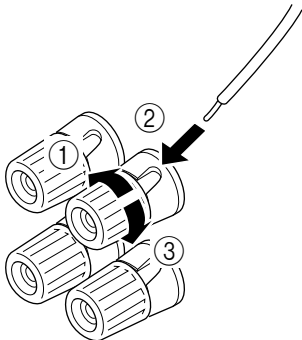

- ① Unscrew the knob.
- ② Insert the bare wire.
[Remove approx. 5mm (1/4") insulation from the speaker wires.]
- ③ Tighten the knob and secure the wire.

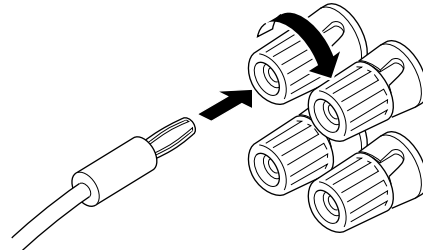

- One or two speaker systems can be connected to this unit. If you connect only one speaker system, connect it to either the **SPEAKERS A** or **B** terminals.
- Use speakers with the specified impedance shown on the rear of this unit.
- Banana Plug connections are also possible (except for Scandinavian models). Simply insert the Banana Plug connector into the corresponding terminal.

ABOUT THE ACCESSORY TERMINALS

AC OUTLETS (SWITCHED)

<Except Australia, U.K. and Europe models of AX-470>

Use these to connect the power cords from your components to this unit.

The power to the **SWITCHED** outlets is controlled by this unit's **POWER** switch or the provided remote control transmitter's **POWER** key. These outlets will supply power to any component whenever this unit is turned on.

The maximum power (total power consumption of components) that can be connected to the **SWITCHED AC OUTLETS** is 100 watts.

REMOTE CONTROL (PHONO) connector

If you have a YAMAHA turntable with a terminal for remote control, connect it to this connector by using the cable provided with the turntable. This connection allows you to control the turntable from the provided remote control transmitter.

GND terminal (For turntable use)

Connecting the ground wire of the turntable to this terminal will normally minimize hum, but in some cases better results may be obtained with the ground wire disconnected.

PRE OUT/MAIN IN terminals

<For AX-570 only>

Removing the jumper pins enables this unit to independently perform the functions of a control amplifier and a power amplifier. These terminals are for connection of a signal-processing system such as a graphic equalizer or sound processor.

If a sound processor or other component is connected, the **VOLUME** control of this unit can be used for overall adjustment of the level of sound. To connect such a unit, remove the jumper pins from the **PRE OUT/MAIN IN** terminals, connect the inputs of that unit to the **PRE OUT** terminals and its outputs to the **MAIN IN** terminals. For details, refer to the owner's manual included with the unit to be connected.

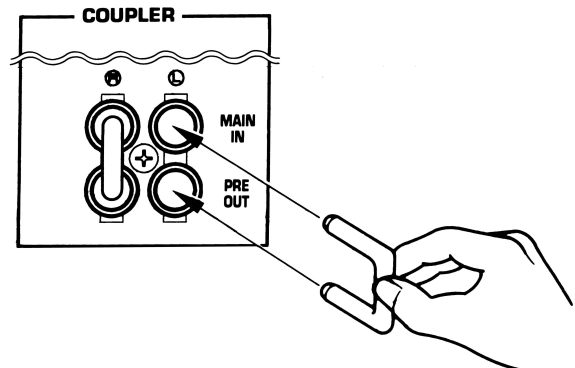

OPERATIONS

<AX-570>

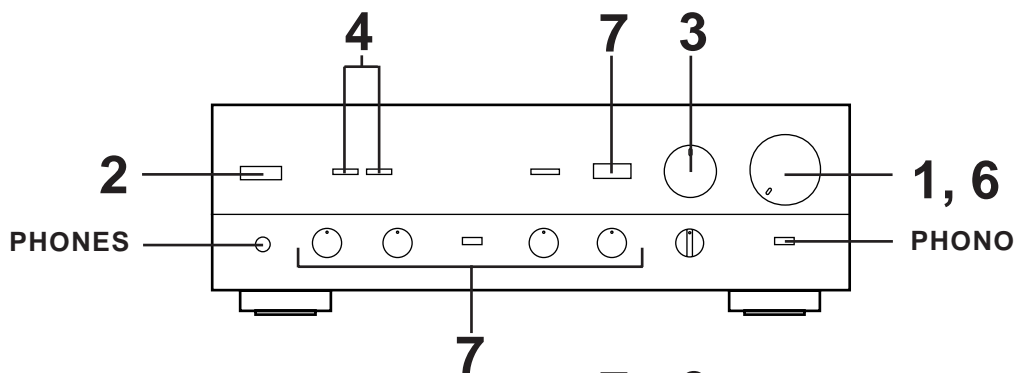

<AX-470>

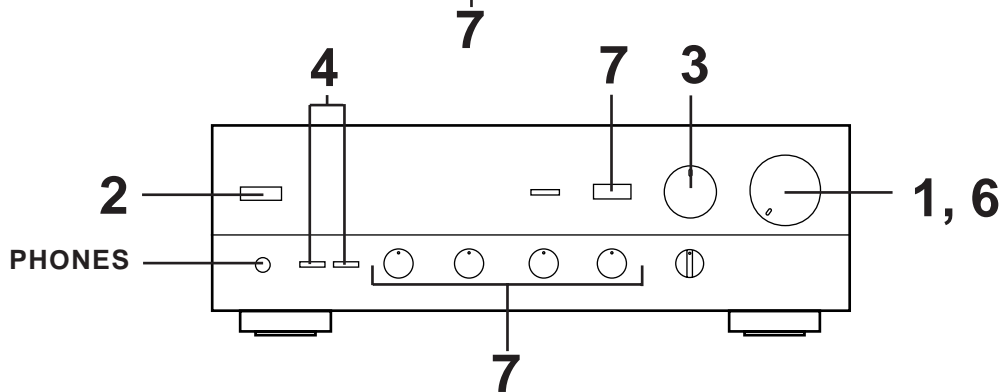

TO PLAY A SOURCE

1

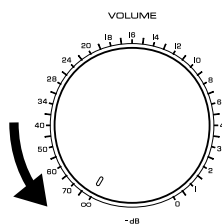

Set to the "∞" position.

2

<AX-570>

POWER

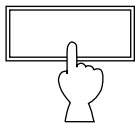

<AX-470>

POWER /STANDBY

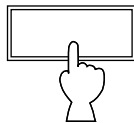

3

Select a desired input source.

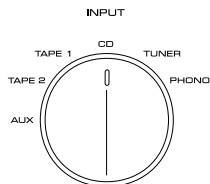

* <For AX-570 only>

If you select turntable as an input source (PHONO position), refer to "Setting the PHONO switch" on page 9.

4

Select the speakers to be used.

<AX-570>

<AX-470>

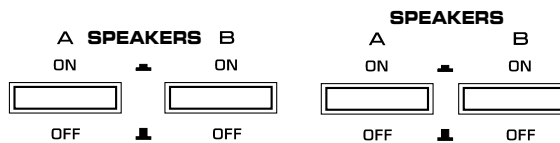

* If you use two speaker systems, press both the A and B switches.

5

Play the source.

6

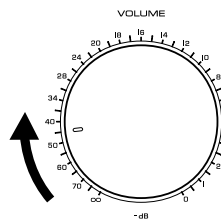

Adjust to the desired output level.

7

If desired, adjust the **BASS, TREBLE, BALANCE** and **LOUDNESS** controls, etc. (Refer to page 8–9.)

<AX-570>

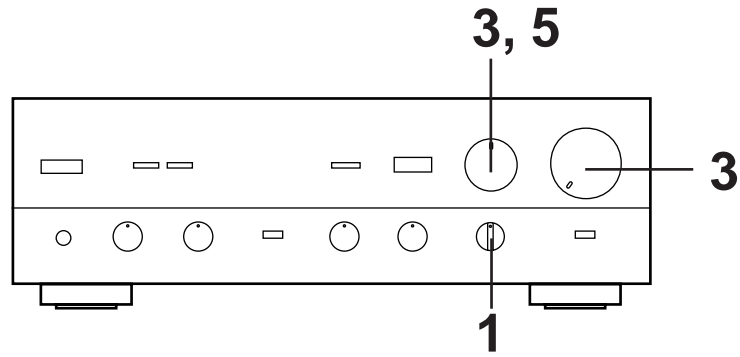

<AX-470>

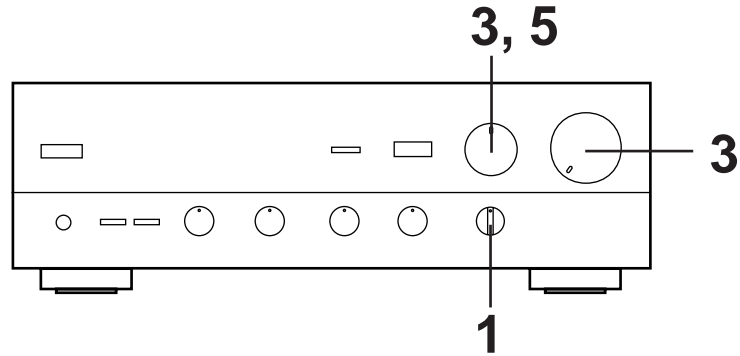

TO RECORD A SOURCE TO TAPE (OR DUB FROM A TAPE TO ANOTHER)

1 Select the source to be recorded.

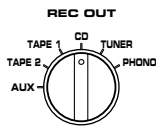

2 Play the source.

3 Confirm the source by selecting it with the **INPUT** selector and turning up the **VOLUME** control.

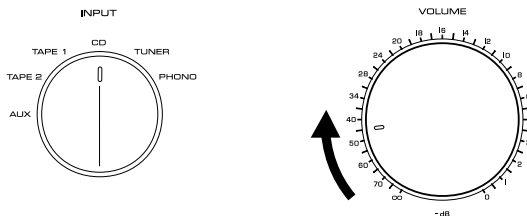

4 Set the tape deck in the recording mode.

5 To monitor the sound being recorded, select the tape deck being used for recording with the **INPUT** selector.

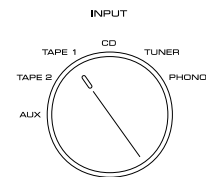

Notes

- If you want to enjoy another source while recording, select it with the **INPUT** selector.
- **VOLUME, BASS, TREBLE, BALANCE, LOUDNESS** controls and **PURE DIRECT** switch settings have no effect on the material being recorded.

Adjusting the BALANCE control

Adjust the balance of the output volume to the left and right speakers to compensate for sound imbalance caused from speaker location or listening room conditions.



Selecting the SPEAKER system

Because one or two speaker systems can be connected to this unit, the **SPEAKERS** switches allow you to select speaker system **A** or **B**, or both at once.

<AX-570>

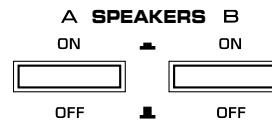

<AX-470>

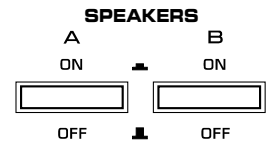

Adjusting the BASS and TREBLE controls

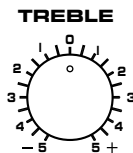

BASS : Turn this clockwise to increase (or counter-clockwise to decrease) the low frequency response.

TREBLE : Turn this clockwise to increase (or counter-clockwise to decrease) the high frequency response.

Adjusting the continuously variable LOUDNESS control

This control provides compensation for the human ears' loss of sensitivity to high and low-frequency ranges at low volume. This control is adjustable to retain full tonal range at any volume level.

1

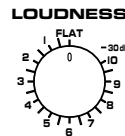

Set to the "FLAT" position.

2

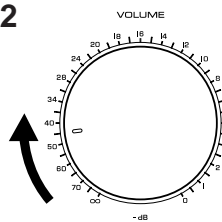

Set to the loudest listening level that you would listen to.

3

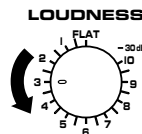

Turn so that the desired volume can be achieved.

Using the PURE DIRECT switch

You can enjoy the purest possible sound from your audio sources by setting this switch so that the indicator illuminates. By doing so, the audio signal bypasses the **BASS**, **TREBLE**, **BALANCE** and **LOUDNESS** controls, eliminating any alterations to the audio signal.

* Concerning AX-570 only, the **SUBSONIC FILTER** switch and the **PRE OUT/MAIN IN** terminals are also bypassed.

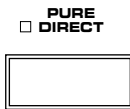

Setting the PHONO switch <For AX-570 only>

Select either MM or MC position depending on your PHONO cartridge, Moving Magnet or Moving Coil type. However, if you use a high output MC cartridge, select MM position.

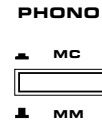

Setting the SUBSONIC FILTER switch <For AX-570 only>

If you set this switch to "ON" position, undesirable ultra-low-frequency signals caused by turntable rumble or warped records can be cut out without losing sound quality.

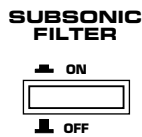

When you listen with headphones

Connect the headphones to the **PHONES** jack. When listening with headphones privately, set both the **SPEAKERS A** and **B** switches to the OFF position.

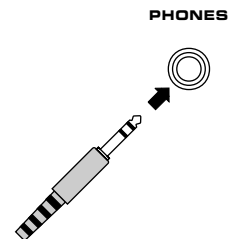

REMOTE CONTROL TRANSMITTER

The remote control transmitter provided with this unit is designed to control all the most commonly used functions of the unit. If the CD player, tuner, turntable, equalizer, and tape deck connected to this unit are YAMAHA components, then this remote control transmitter will also control various functions of each component.

KEY FUNCTIONS

For Control of This Unit

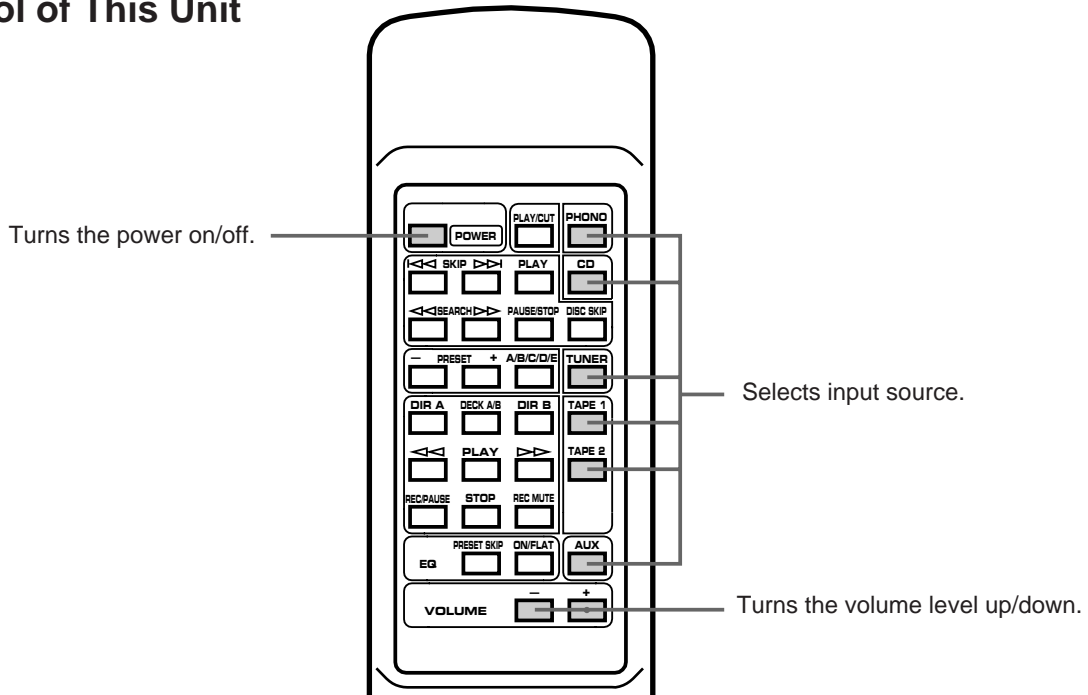

For Other Component Control

Identify the remote control transmitter keys with your component's keys. If these keys are identical, their function will be the same. On each key function, refer to the corresponding instruction on your component's manual.

Controls tuner

+: Selects higher preset station number.

-: Selects lower preset station number.

A/B/C/D/E: Selects the page (A – E) of preset station buttons.

Controls equalizer.

* **PRESET SKIP** selects any preset equalizer curve whenever this is pressed. (After the last preset curve is selected, it returns to the first one by another press on this key.)

Starts/stops record play on turntable.

Controls compact disc player.

* **DISC SKIP** is applicable only to compact disc changer.

Controls tape deck.

* **DIR A**, **B** and **DECK A/B** are applicable only to double cassette tape deck.

* For a single cassette deck with automatic reverse function, pressing **DIR A** will reverse the direction of tape running.

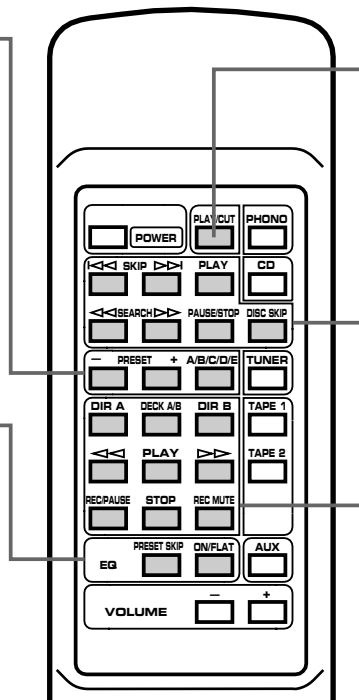

STANDBY mode

<For AX-470 and Europe model of AX-570>

While the power is on, pressing the **POWER** key on the remote control transmitter switches the unit to the STANDBY mode. (In this mode, the indicator is half illuminated.)

Note

The **POWER** switch on the front panel of this unit should be turned off when left unused for a long period of time.

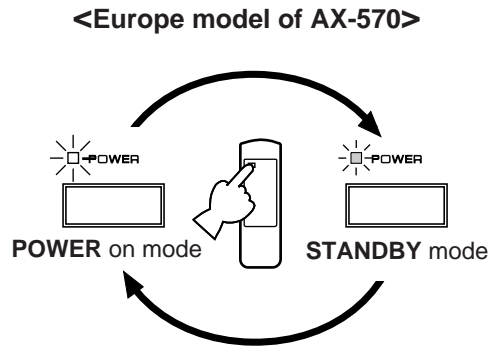
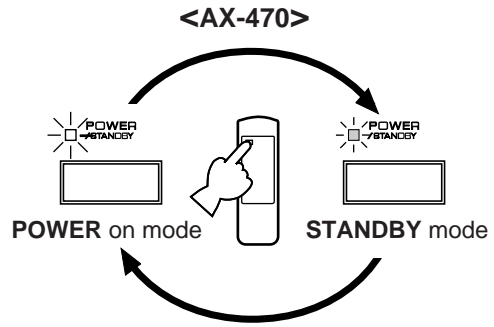

NOTES ABOUT THE REMOTE CONTROL TRANSMITTER

Battery installation

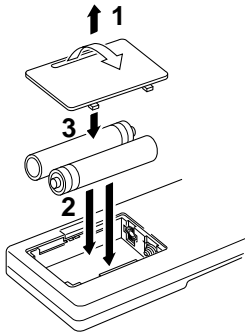

Battery replacement

If you find that the remote control transmitter must be used closer to the main unit, the batteries are weak. Replace both batteries with new ones.

Notes

- Use only AA, R6, UM-3 batteries for replacement.
- Be sure the polarities are correct. (See the illustration inside the battery compartment.)
- Remove the batteries if the remote control transmitter will not be used for an extended period of time.
- If batteries leak, dispose of them immediately. Avoid touching the leaked material or letting it come in contact with clothing, etc. Clean the battery compartment thoroughly before installing new batteries.

Remote control transmitter operation range

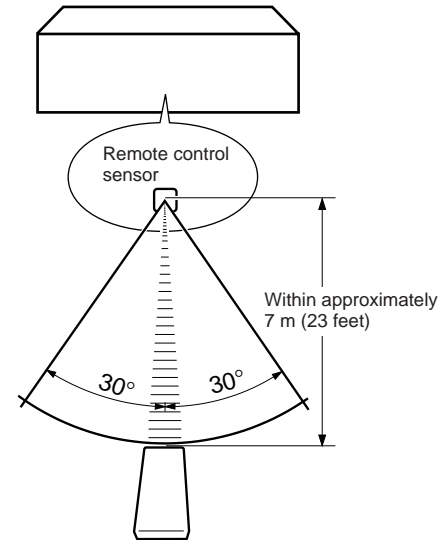

Notes

- There should be no large obstacles between the remote control transmitter and the main unit.
- If the remote control sensor is directly illuminated by strong lighting (especially an inverter type of fluorescent lamp etc.), it might cause the remote control transmitter not to work correctly. In this case, reposition the main unit to avoid direct lighting.

TROUBLESHOOTING

If the unit fails to operate normally, check the following points to determine whether the fault can be corrected by the simple measures suggested. If it cannot be corrected, or if the fault is not listed in the SYMPTOM column, disconnect the power cord and contact your authorized YAMAHA dealer or service center for help.

SYMPTOM	CAUSE	REMEDY
The unit fails to turn on when the POWER switch is pressed.	Power cord is not plugged in or is not completely inserted.	Firmly plug in the power cord.
No sound.	Incorrect output cord connections.	Connect the cords properly. If the problem persists, the cords may be defective.
	Appropriate input source is not selected.	Select an appropriate input source with the INPUT selector.
	Speaker connections are not secure.	Secure the connections.
The sound suddenly goes off.	The protection circuit has activated because of short circuit etc.	Turning the unit off and then on will reset the protection circuit.
Only one side speaker outputs the sound.	Incorrect setting of the BALANCE control.	Adjust it to the appropriate position.
	Incorrect cord connections.	Connect the cords properly. If the problem persists, the cords may be defective.
There is a lack of bass, and no ambience.	The + and – wires are connected in reverse at the amplifier or speakers.	Connect the speaker wires in the correct phase (+ and –).
Sound “hums”.	Incorrect cord connections.	Firmly connect the audio plugs. If the problem persists, the cords may be defective.
	No connection from the turntable to the GND terminal.	Make the GND connection between the turntable and this unit.
Sound level is low.	The LOUDNESS control is functioning.	Set the LOUDNESS control to the FLAT position.
Using the BASS, TREBLE, BALANCE, LOUDNESS controls and SUBSONIC FILTER switch (AX-570 only) does not affect the tone.	The PURE DIRECT switch is ON.	The PURE DIRECT switch must be switched OFF to use those controls.
The remote control transmitter does not work.	Direct sunlight or lighting (of an inverter type of fluorescent lamp etc.) is striking the remote control sensor of the main unit.	Change position of the main unit.
The distance or range within which the remote control transmitter can be used decreases.	The batteries of this remote control transmitter are too weak.	Replace the batteries with new ones.

SPECIFICATIONS

Minimum RMS Output Power per Channel (PURE DIRECT; ON)

<AX-570>
8 ohms, 20 Hz to 20 kHz, 0.015% THD100W+100W
6 ohms, 20 Hz to 20 kHz, 0.03% THD [Except Scandinavia model]120W+120W

<AX-470>
8 ohms, 20 Hz to 20 kHz, 0.015% THD [Except Europe model]65W+65W [Europe model]75W+75W
6 ohms, 20 Hz to 20 kHz, 0.03% THD [U.S.A. and Canada model]75W+75W [Australia, U.K. and General model]70W+70W [Europe (except Scandinavia) model]80W+80W

Dynamic Power per Channel (by IHF Dynamic Headroom measuring method)

<AX-570>
8/6/4/2 ohms.....140/170/220/290W

<AX-470>
[Except Europe model]
8/6/4/2 ohms.....95/115/135/160W [Europe model]
8/6/4/2 ohms.....115/135/160/180W

DIN Standard Output Power per Channel (4 ohms, 1 kHz, 0.7% THD) [Europe model only]

<AX-570>150W
<AX-470>110W

IEC Power (8 ohms, 1 kHz, 0.015% THD) [Europe model only]

<AX-570>110W
<AX-470>85W

Power Band Width

<AX-570>
8 ohms, 50W, 0.03% THD10 Hz to 50 kHz

<AX-470>
8 ohms, 35W, 0.03% THD10 Hz to 50 kHz

Damping Factor

8 ohms, 20 Hz–20 kHz

<AX-570>320
<AX-470>240

Damping Factor (DIN)

4 ohms, 40 Hz [Australia, U.K. and Europe models]

<AX-570>160
<AX-470>120

Input Sensitivity/Impedance

PHONO MM2.5 mV/47 k-ohms
PHONO MC <AX-570 only>160 µV/220 ohms
CD/TUNER/TAPE/AUX150 mV/47 k-ohms
MAIN IN <AX-570 only>1.0V/10 k-ohms

Maximum Input Signal (1 kHz, 0.01% THD)

<AX-570>
PHONO MM150 mV
PHONO MC10 mV

<AX-470>
PHONO MM115 mV

Output Level/Impedance

<AX-570>
REC OUT150 mV/220 ohms
PRE OUT1.0V/470 ohms

<AX-470>
REC OUT150 mV/1 k-ohm

Headphone Jack Rated Output/ Impedance

<AX-570>
Output Level (8 ohms, 1 kHz, 0.015% THD)0.47V
Impedance470 ohms

<AX-470>
Output Level (8 ohms, 1 kHz, 0.019% THD)0.46V
Impedance390 ohms

Frequency Response (20 Hz to 20 kHz)

CD/TUNER/TAPE/AUX0±0.5 dB
MAIN IN <AX-570 only>0±0.5 dB

RIAA Equalization Deviation (20 Hz to 20 kHz)

PHONO MM±0.3 dB
PHONO MC <AX-570 only>±0.5 dB

Total Harmonic Distortion (20 Hz to 20 kHz)

<AX-570>
PHONO MM to REC OUT (3V)0.003%
PHONO MC to REC OUT (3V)0.007%
CD/TUNER/TAPE/AUX to PRE OUT (1V)0.005%
CD/TUNER/TAPE/AUX to SP OUT (50W/8 ohms)0.008%

<AX-470>
PHONO MM to REC OUT (3V)0.003%
CD/TUNER/TAPE/AUX to SP OUT (35W/8 ohms)0.008%

Intermodulation Distortion (Rated output/8 ohms)0.01%

Signal-to-Noise Ratio (IHF-A Network)

<AX-570>
PHONO MM (5 mV Input Shorted)92 dB
PHONO MC (0.5 mV Input Shorted)76 dB
CD/TUNER/TAPE/AUX (Input Shorted)110 dB

<AX-470>
PHONO MM (5 mV Input Shorted)88 dB
CD/TUNER/TAPE/AUX (Input Shorted) (PURE DIRECT; ON)110 dB

Residual Noise (IHF-A Network) (PURE DIRECT; ON)70 µV

Channel Separation (Vol. –30 dB)

<AX-570>
PHONO MM/MC (Input Shorted) 1 kHz/10 kHz75 dB/60 dB
CD/TUNER/TAPE/AUX (Input 5.1 k-ohms Terminated 1 kHz/10 kHz)65 dB/50 dB

<AX-470>
CD/TUNER/TAPE/AUX (Input 5.1 k-ohms Terminated 1 kHz/10 kHz)65 dB/50 dB

Tone Control Characteristics

BASS: Boost/cut±10 dB (20 Hz)
TREBLE: Boost/cut±10 dB (20 kHz)

Filter Characteristics <AX-570 only>
SUBSONIC FILTER15 Hz, –18 dB/oct

Continuous Loudness Control

Attenuation–30 dB (1 kHz) (Level related equalization)

Gain Tracking Error (0 to –60 dB)

<AX-570>2 dB
<AX-470>3 dB

Power Supply

[U.S.A. and Canada models]AC 120V, 60 Hz
[Australia and U.K. models]AC 240V, 50 Hz
[Europe model]AC 230V, 50 Hz
[General model]AC 110/120/220/240V, 50/60 Hz

Power Consumption

<AX-570>
[U.S.A. model]200W
[Canada model]330 VA, 260W
[Australia and U.K. models]210W
[Scandinavia model]180W
[Europe (except Scandinavia) and General models]210W

<AX-470>
[U.S.A. model]160W
[Canada model]280 VA, 220W
[Australia and U.K. models]170W
[Scandinavia model]160W
[Europe (except Scandinavia) model]190W
[General model]170W

AC Outlets

[Except Australia, U.K. and Europe models of AX-470]
SWITCHED OUTLETS100W max. total

Dimensions (W x H x D)435 x 150 x 388.5 mm (17-1/8" x 5-7/8" x 15-5/16")

Weight

<AX-570>11 kg (24 lbs. 3 oz.)
<AX-470>9.5 kg (20 lbs. 14 oz.)

AccessoriesRemote control transmitter
Batteries

Specifications subject to change without notice.

YAMAHA

YAMAHA ELECTRONICS CORPORATION, USA 6660 ORANGETHORPE AVE., BUENA PARK, CALIF. 90620, U.S.A.
YAMAHA CANADA MUSIC LTD. 135 MILNER AVE., SCARBOROUGH, ONTARIO M1S 3R1, CANADA
YAMAHA ELECTRONIK EUROPA G.m.b.H. SIEMENSSTR. 22-34, 25462 RELLINGEN BEI HAMBURG, F.R. OF GERMANY
YAMAHA ELECTRONIQUE FRANCE S.A. RUE AMBROISE CROIZAT BP70 CROISSY-BEAUBOURG 77312 MARNE-LA-VALLEE CEDEX02, FRANCE
YAMAHA ELECTRONICS (UK) LTD. YAMAHA HOUSE, 200 RICKMANSWORTH ROAD WATFORD, HERTS WD1 7JS, ENGLAND
YAMAHA SCANDINAVIA A.B. J A WETTERGRENS GATA 1, BOX 30053, 400 43 VÄSTRA FRÖLUNDA, SWEDEN
YAMAHA MUSIC AUSTRALIA PTY, LTD. 17-33 MARKET ST., SOUTH MELBOURNE, 3205 VIC., AUSTRALIA

YAMAHA CORPORATION