

YAMAHA KX-10

Natural Sound Stereo Cassette Deck

Platine à cassette stéréo de la série "Natural Sound"

"Natural Sound" Stereo-Kassettengerät

Natural Sound stereokassettdäck

Registratore a cassette stereo a suono naturale

Magnetófono estéreo de sonido natural

Stereo-cassettedeck voor een "natuurlijk geluid"

OWNER'S MANUAL
MODE D'EMPLOI
BEDIENUNGSANLEITUNG
BRUKSANVISNING
MANUALE DI ISTRUZIONI
MANUAL DE INSTRUCCIONES
GEBRUIKSAANWIJZING

CAUTION: READ THIS BEFORE OPERATING YOUR UNIT.

1. This unit is a sophisticated stereo cassette deck. To ensure proper operation for the best possible performance, please read this manual carefully.
2. Choose the installation location of your unit carefully. Avoid placing it in direct sunlight or close to source of heat. Also avoid locations subject to vibration and excessive dust, heat, cold or moisture. Keep it away from sources of hum such as transformers or motors.
3. Do not open the cabinet as this may result in damage to the deck or electrical shock. If a foreign object should get into the deck, contact your local dealer.
4. When removing the power plug from the wall outlet, always pull directly on the plug; never pull the cord itself.
5. Do not apply excessive force when operating switches and knobs.
6. When moving the deck, be sure to first pull out the power plug and remove all cords connecting the deck to other equipments.
7. Do not attempt to clean this unit with chemical solvents as this may damage the finish. Use a clean, dry cloth.
8. Never allow metallic items (e.g. screwdrivers, tools, etc.) to come near the record/playback head assembly. Doing so may not only scratch or damage the head's mirror-smooth finish, but also change the magnetic characteristics of the heads, causing a deterioration in reproduction quality.
9. Although the record/playback head used in this unit is a high quality head with outstanding reproduction characteristics, it can become dirty through the use of old tapes or from dust accumulation over time. This can have a serious effect on reproduction quality. Clean the heads regularly with one of the commonly available head cleaners or with cleaning solutions as explained later in this manual.
10. Be sure to read the "Troubleshooting" section of this manual for advice on common operating errors before concluding that your unit is faulty.
11. Keep this manual in a safe place for future reference.
12. **Voltage Selector (General Model only)**
The voltage selector on the rear panel of this unit must be set for your local mains voltage BEFORE plugging in the AC mains supply.

Please check the copyright laws in your country to record from records, compact discs, radio, etc. Recording of copyright material may infringe copyright laws.

WARNING

TO REDUCE THE RISK OF FIRE OR ELECTRIC SHOCK, DO NOT EXPOSE THIS APPLIANCE TO RAIN OR MOISTURE.

For U.K. customers

If the socket outlets in the home are not suitable for the plug supplied with this appliance, it should be cut off and an appropriate 3 pin plug fitted. For details, refer to the instructions described below.

Note: The plug severed from the mains lead must be destroyed, as a plug with bared flexible cord is hazardous if engaged in a live socket outlet.

Special Instructions for U.K. Model

IMPORTANT

The wires in the mains lead are coloured in accordance with the following code:

Blue: NEUTRAL
Brown: LIVE

As the colours of the wires in the mains lead of this apparatus may not correspond with the coloured markings identifying the terminals in your plug, proceed as follows. The wire which is coloured BLUE must be connected the terminal which is marked with the letter N or coloured BLACK. The wire which is coloured BROWN must be connected to the terminals which is marked with the letter L or coloured RED. Making sure that neither core is connected to the earth terminal of the three pin plug.

Special Instructions for Canada Model

THIS DIGITAL APPARATUS DOES NOT EXCEED THE "CLASS B" LIMITS FOR RADIO NOISE EMISSIONS FROM DIGITAL APPARATUS SET OUT IN THE RADIO INTERFERENCE REGULATION OF THE CANADIAN DEPARTMENT OF COMMUNICATIONS.

CAUTION: TO PREVENT ELECTRIC SHOCK, MATCH WIDE BLADE OF PLUG TO WIDE SLOT AND FULLY INSERT.

This unit is not disconnected from the AC power source as long as it is connected to the wall outlet, even if this unit itself is turned off. This state is called the standby mode. In this state, this unit is designed to consume a very small quantity of power.

TABLE OF CONTENTS

FEATURES	3	CASSETTE TAPES	12
CONNECTIONS	4	MAINTENANCE	13
PLAYBACK	5	OPTIONAL REMOTE CONTROL TRANSMITTER	13
SELECTION SEARCH	7	TROUBLESHOOTING	14
RECORDING	8	SPECIFICATIONS	15
VARIOUS FUNCTIONS HELPFUL FOR HIGH QUALITY			
RECORDING	10		
REC MUTE OPERATION	11		
REC RETURN OPERATION	11		
0-RETURN OPERATION	11		

FEATURES

- 3-Head Configuration
- Dolby HX Pro Dynamic Bias Servo
- Dolby B/C Noise Reduction
- Auto Tape Tuning improves the quality of recording by automatically adjusting the recording characteristics (recording bias and sensitivity) for best result with every cassette tape
- Play Trim Control for Improved Playback Compatibility with Other Decks
- Selection Search
- Recording Mute Function
- Rec Return/0-Return Function
- Integrated System Remote Control Compatibility

Note on transportation

This cassette tray protector protects against shock during transportation.

Be sure to remove the protector before operating the unit, and keep it for future use.

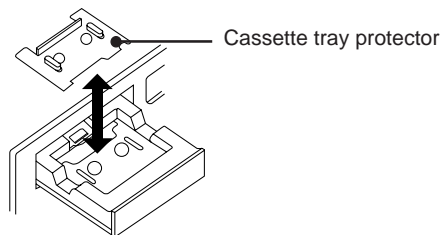

CONNECTIONS

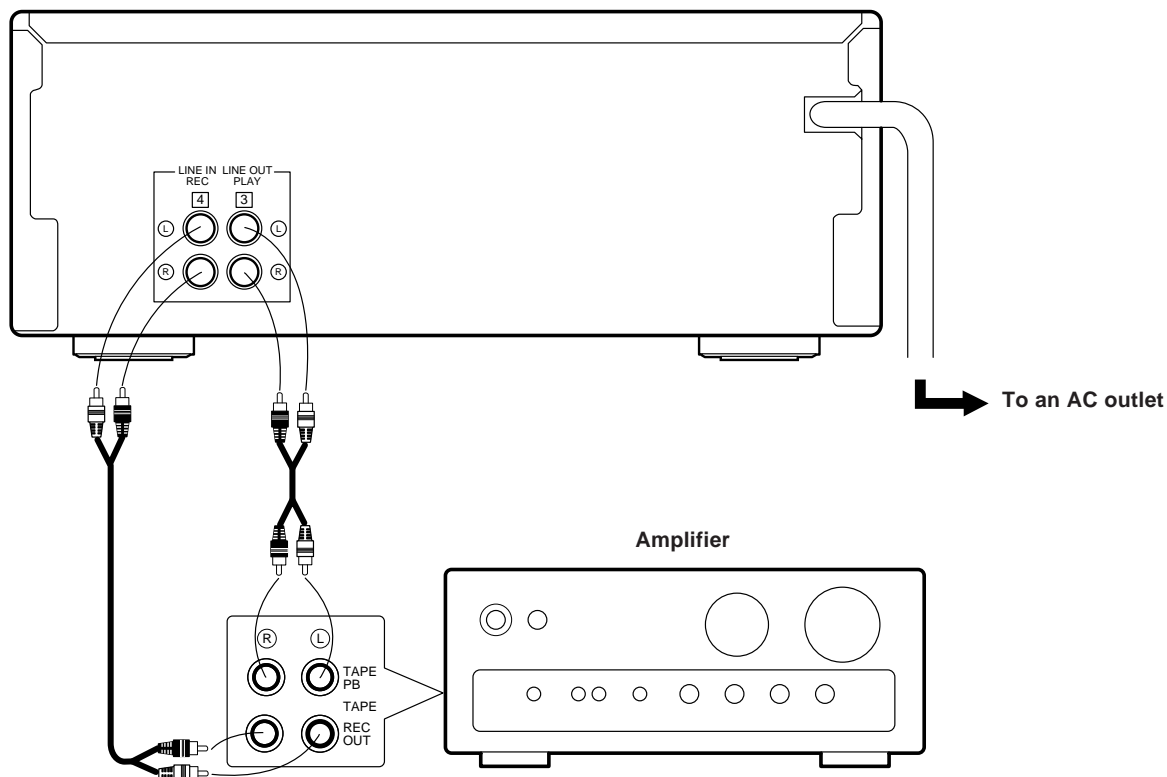

REAR PANEL CONNECTIONS

Make sure that power to both the deck and your amplifier/receiver are turned off before making any connection.

- The White plug on the paired connecting cables corresponds to the Left channel and the Red plug corresponds to the Right channel. Make sure that the left and right channel connections are properly made, and that the plugs are inserted firmly.
- The LINE OUT/PLAY jacks on the deck should be connected to the Tape PB (Playback/Input) jacks on your amplifier/receiver, and the LINE IN/REC jacks on the deck should be connected to the REC OUT (Recording/Output) jacks on your amplifier/receiver. When using the amplifier AX-10, connect them referring to the numbers [3] and [4] on both units.

- Connect the power cord to an AC wall outlet or to an AC outlet on the rear panel of your amplifier/receiver (if provided).

PLAYBACK

Preparation for playback

- Press the STANDBY/ON switch to turn on the power.
- Set your amplifier to cassette deck function mode.

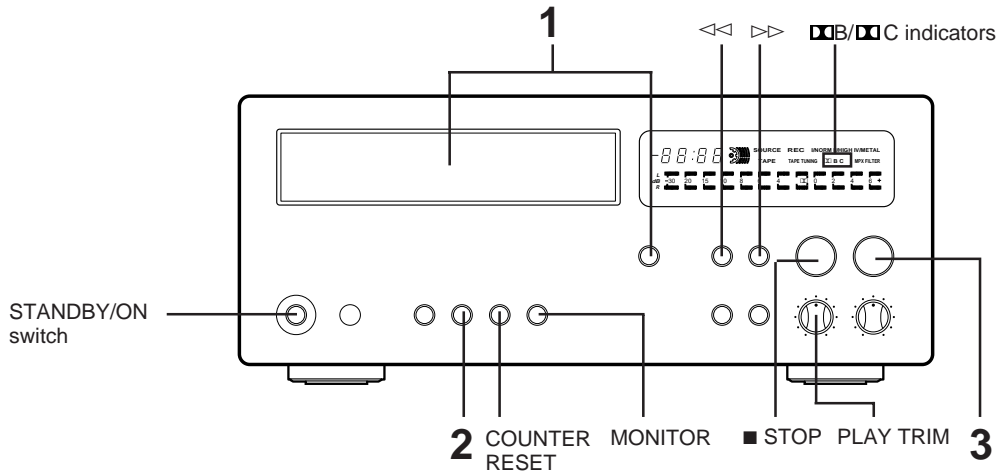

<p>1</p> <p>Place the cassette on the cassette tray with the exposed tape side facing back side of the unit and the side to be played facing up. To load the cassette tray, press the button.</p> <ul style="list-style-type: none"> ● Make sure that the tape is wound to the right-hand reel with the cassette placed on the tray. 	<p>2</p> <p>DOLBY NR OFF ON</p> <p>Refer to "DOLBY NR button setting".</p>	<p>3</p> <p>▷ PLAY</p>
---	---	-------------------------------

DOLBY NR button setting (in step 2)

Be sure to set the DOLBY NR button according to the system used for recording. Each time this button is pressed, Dolby NR switches as follows:

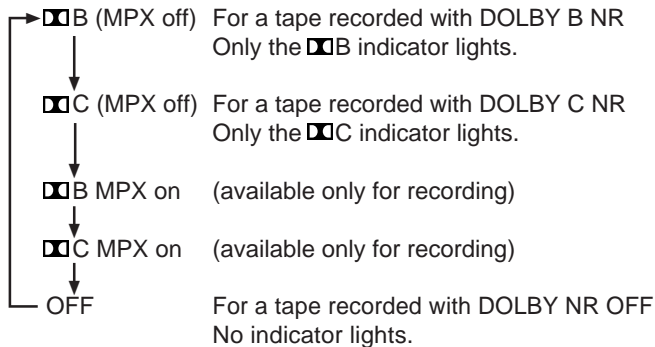

Note:

The MPX filter settings are explained on page 8.

* Dolby noise reduction manufactured under license from Dolby Laboratories Licensing Corporation. "DOLBY" and the double-D symbol **DD** are trademarks of Dolby Laboratories Licensing Corporation.

To fast forward the tape

Press the **>>>** button.

To fast rewind the tape

Press the **<<<** button.

To adjust the volume level

Use the volume control of the amplifier.

To stop playback and remove the cassette tape

Press the **■ STOP** button and then the **△** button. The cassette tray comes out and you can remove the cassette tape.

To enter the standby mode

Press the STANDBY/ON switch again.

Display during playback

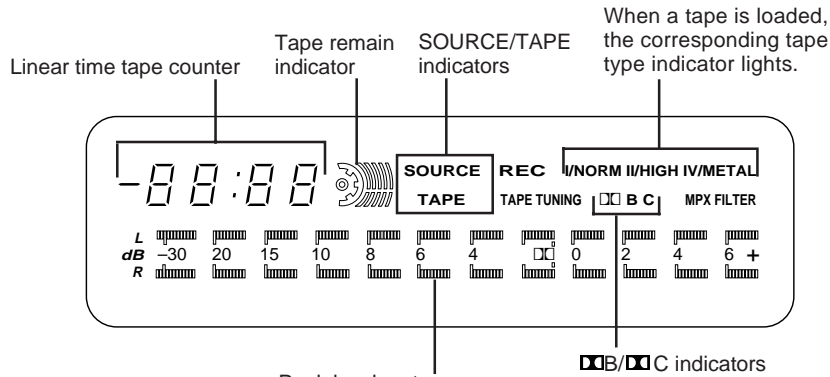

Peak level meters:
Indicate the peaks of the signal levels during recording and playback over a -30 dB to +6 dB range. There are separate meters for each left and right channel. These level meters have a peak hold function which holds the peak level for about 1.5 seconds. (The peak hold function works in the level from -10 dB to +6 dB.)

Linear time tape counter

Use the linear time tape counter as an aid in locating a point on a tape (-99 min. 59 sec. to 99 min. 59 sec.). To set the counter reading to "0:00", press the COUNTER RESET button.

Note: Precision of counter

The tape counter is not a clock, and so there will be some errors in the time display compared to the actual playing time (this cannot be avoided, as a suitable method is adopted to provide a time display not only during recording and playback, but also during fast forward and rewind). The error depends on the type of tape being used.

Tape remain indicator

The tape remain indicator shows the remaining length of the loaded tape to be played back. When the playback reaches the end of the tape, the leftmost digit of the tape remain indicator blinks.

Indicates the remaining tape length.

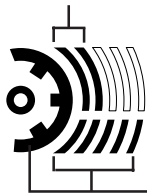

Lights when a tape is loaded.

Note:

The tape remain indicator may differ depending on the tape length, tape type or the size of hub. So, use this indicator as an aid to recognize the remaining length of the tape to be played back.

Notes on the monitor function

During playback, the deck automatically selects the tape monitor mode. (The TAPE indicator lights.) If the monitor mode is switched to the source monitor mode by pressing the MONITOR button, no sound is heard. (The SOURCE indicator lights.)

During playback, be sure to set the MONITOR button so that the TAPE indicator lights.

PLAY TRIM control adjustment

When distortion or the absence of high frequencies is noticeable while playing a tape recorded on another cassette deck, compensate the high frequency response with the PLAY TRIM control.

When high frequencies are too loud, attenuate the high frequencies.

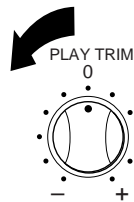

When high frequencies are too soft, boost the high frequencies.

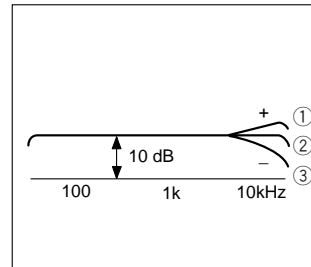

- ① High frequency sound is too boosted.
- ② Flat
- ③ High-frequency sound is absent.

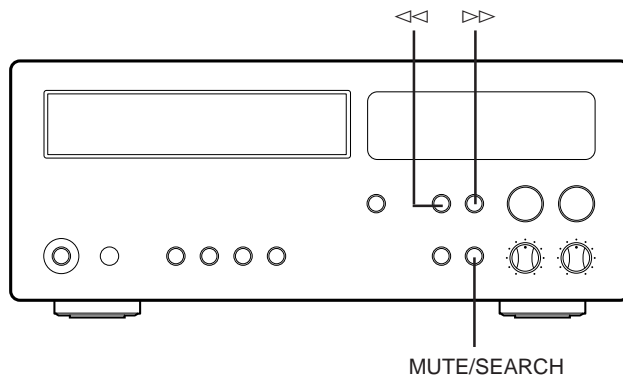

SELECTION SEARCH — To play back a desired selection by searching for the beginning of the selection

To search for the next selection

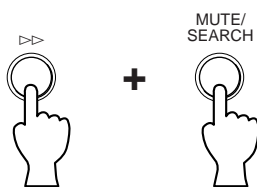

The $\triangleright\triangleright$ button and the MUTE/SEARCH button should be pressed simultaneously.

To search for the selection located before the current selection

When the beginning of the current selection is played:

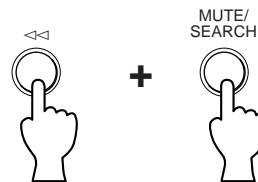

The $\triangleleft\triangleleft$ button and the MUTE/SEARCH button should be pressed simultaneously.

To search for the beginning of the current selection

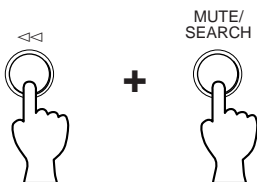

The $\triangleleft\triangleleft$ button and the MUTE/SEARCH button should be pressed simultaneously.

Notes on Selection search

- The blank section between selections must be at least 4 seconds.
- With tapes recorded with low level or fade-in or fade-out function, or with tapes having excessive noise, selection search may not be carried out.

RECORDING

Preparation for recording

- Press the STANDBY/ON switch to turn on the power.
- Set your amplifier to cassette deck function mode.

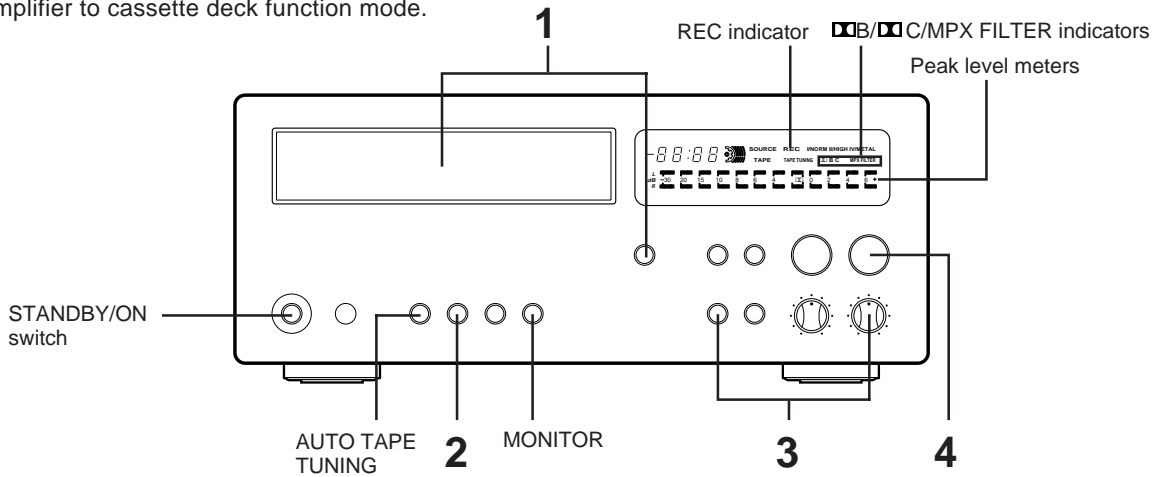

<p>1</p> <p>Place the cassette on the cassette tray with the exposed tape side facing back side of the unit and the side to be recorded facing up. To load the cassette tray, press the button.</p> <ul style="list-style-type: none"> ● Make sure that the tape is wound to the right-hand reel with the cassette placed on the tray. 	<p>2</p> <p>DOLBY NR OFF / ON / MPX</p> <p>Refer to "DOLBY NR button setting".</p>
<p>3</p> <p>Play the program source to be recorded and adjust the recording level. See "Setting the recording level".</p>	<p>4</p> <p>▷ PLAY</p>

DOLBY NR button setting (in step 2)

Dolby noise reduction is an extremely effective method of reducing undesirable background hiss on tapes. This unit incorporates both Dolby B NR and the newer Dolby C NR system. Dolby C NR is approximately twice as effective as the earlier Dolby B NR.

Each time this button is pressed, Dolby NR switches as follows:

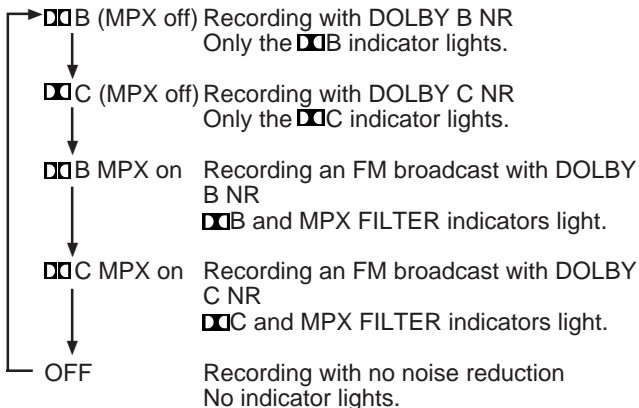

MPX filter

FM stations transmit a 19 kHz pilot signal in addition to the broadcast program. Sometimes this pilot signal may leak into the audio output depending on the tuner and broadcast conditions. This signal can cause improper operation of the Dolby NR systems. Activating the MPX filter (B TYPE/C TYPE MPX ON settings) will effectively remove the signal.

Display during recording

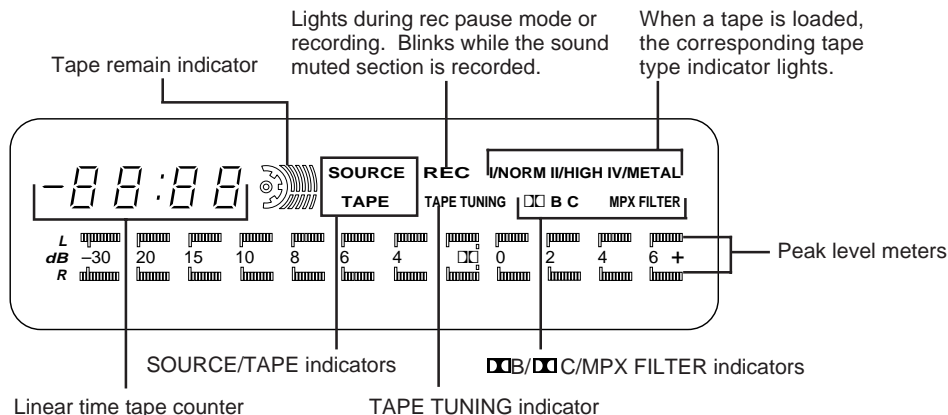

Setting the recording level (in step 3)

Play the loudest passage of the source to be recorded and watch the meter readings. When using Normal position tapes (type I/NORM) or High position tapes (type II/HIGH (CrO₂)), adjust the REC LEVEL control so that the highest peak is +4 dB. When using Metal position tapes (type IV/METAL), adjust the REC LEVEL control so that the highest peak is +6 dB. (Refer to the figure below.)

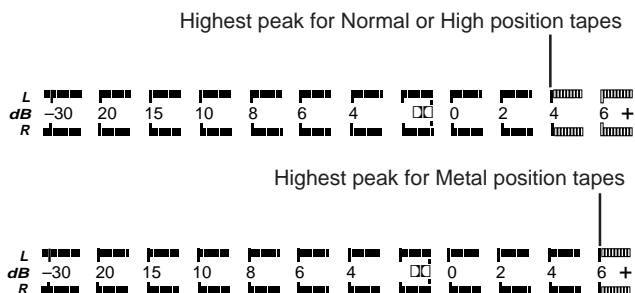

Note:

The tape remain indicator may differ depending on the tape length, tape type or the size of hub. So, use this indicator as an aid to recognize the remaining length of the tape to be played back.

To stop recording temporarily

Press the REC/PAUSE button. To resume recording, press the ► PLAY button.

To stop recording and remove the cassette tape

Press the ■ STOP button and then the △ button. The cassette tray comes out and you can remove the cassette tape.

To enter the standby mode

Press the STANDBY/ON switch again.

Linear time tape counter

Use the linear time tape counter as an aid in locating a point on a tape (-99 min. 59 sec. to 99 min. 59 sec.). To set the counter reading to "0:00", press the COUNTER RESET button.

Note: Precision of counter

The tape counter is not a clock, and so there will be some errors in the time display compared to the actual recording time (this cannot be avoided, as a suitable method is adopted to provide a time display not only during recording and playback, but also during fast forward and rewind). The error depends on the type of tape being used.

Tape remain indicator

The tape remain indicator shows the remaining length of the loaded tape to be recorded.

When the recording reaches the end of the tape, the leftmost digit of the tape remain indicator blinks.

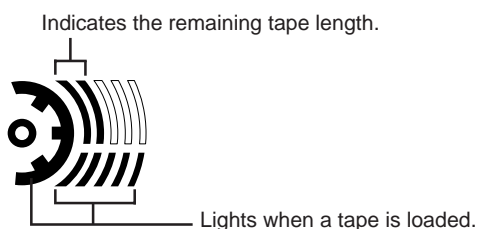

Three head system

The three-head system allows the just-recorded sound to be monitored while recording. You can compare the difference between the recorded sound and the source sound by switching the monitor mode (SOURCE or TAPE) with the MONITOR button, so you can try to obtain a recording sound identical to the source sound.

To monitor the just recorded sound

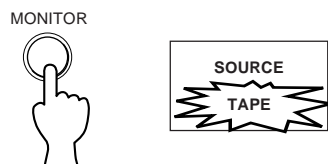

To monitor the sound to be recorded

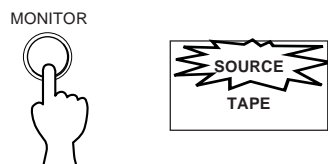

VARIOUS FUNCTIONS HELPFUL FOR HIGH QUALITY RECORDING

This deck has a built-in Auto Tape Selector which automatically adjusts the recording characteristics according to the tape formulation (see page 12) and a Dolby HX Pro Dynamic Bias Servo System which automatically controls the effective bias during recording. In addition to these functions, you can refine your recordings by using the Auto Tape Tuning function, which adjusts the recording bias and sensitivity for each tape you use.

Auto tape tuning function

The auto tape tuning function improves the quality of recording, permitting precise adjustment of the deck's recording bias and sensitivity for best results with every tape you use.

With the auto tape tuning function, the recording characteristics (recording bias and sensitivity) are automatically adjusted in two frequency ranges (500 Hz and 10 kHz) while performing recording and playback operations simultaneously for about 20 seconds, to accurately match the characteristics of the loaded tape.

For example, the recorded (output) level (A in the figure) may differ from the recording (input) level (B in the figure), due to widely varying characteristics between brands of cassette tapes.

Using the auto tape tuning function, these differences are effectively eliminated by adjusting the recording bias (for high frequencies) and sensitivity (for overall frequencies) according to the loaded cassette tape, making a significant contribution to overall recording quality (C in the figure).

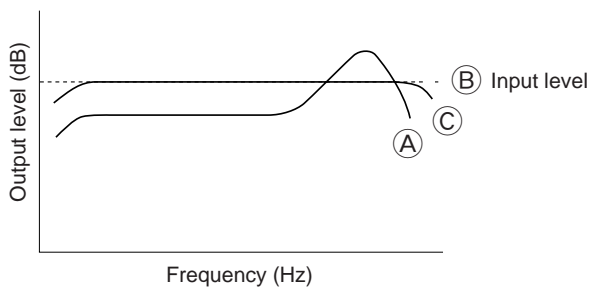

<Operation>

1. Set the **PLAY TRIM** control to the center position.
2. Press the **REC/PAUSE** button to enter the rec pause mode and adjust the recording level with the **REC LEVEL** control.
3. Press the **AUTO TAPE TUNING** button.

The TAPE TUNING indicator blinks and the deck determines the optimum recording characteristics (bias and recording sensitivity) according to the loaded cassette tape in about 20 seconds. After completion of auto tape tuning, the tape is automatically rewound to the point where auto tape tuning began and the deck enters the rec pause mode. The TAPE TUNING indicator lights up.

- Auto tape tuning may not function with a tape of poor quality. In this case, the tape stops and the TAPE TUNING indicator does not light up.
- The adjusted recording characteristics are not cancelled as long as the TAPE TUNING indicator is lit. When you no longer need this adjustment, press the AUTO TAPE TUNING button in rec pause mode or stop mode. The TAPE TUNING indicator goes out. This adjustment is also cancelled when the \triangle button is pressed.

Note

When loading a tape of different brand even if whose tape types are the same, perform the auto tape tuning operation again even when the TAPE TUNING indicator lights up.

DOLBY HX PRO DYNAMIC BIAS SERVO SYSTEM

This unit incorporates the Dolby HX Pro system which automatically controls the effective bias to reduce distortion and noise, improving high frequency response during recording. Tapes recorded with this system retain the same high quality even when played back on other cassette decks.

Dolby noise reduction and HX Pro headroom extension manufactured under license from Dolby Laboratories Licensing Corporation, HX Pro originated by Bang & Olufsen.

“DOLBY”, the double-D symbol  and “HX PRO” are trademarks of Dolby Laboratories Licensing Corporation.

Synchronized recording function

When operating this unit in combination with the YAMAHA CD Player which has SYNCHRO button on its remote control transmitter, CD Synchronized recording function can be utilized. This function is operated with the remote control transmitter of the CD Player. (Regarding the operation, refer to the manual of the CD Player.)

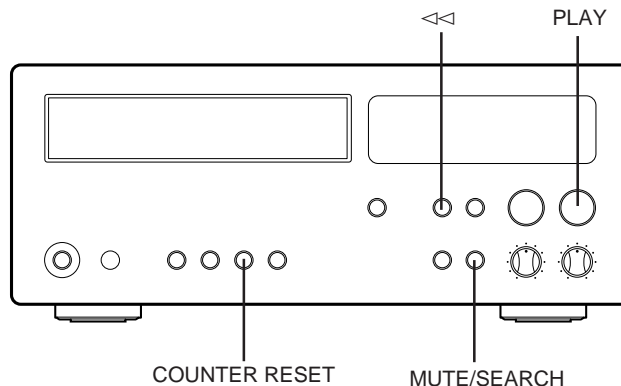

REC MUTE OPERATION — Inserting a blank space during recording

During recording



A 4-second blank interval is automatically recorded on the tape, and then the deck enters rec pause mode. If a blank interval longer than 4 seconds is desired, keep pressing for as long as you want. When the MUTE/SEARCH button is released, the deck enters rec pause mode after making a 4-second blank interval. To resume recording, press the ► PLAY button.

0-RETURN OPERATION — To return to the "0:00" point

During recording



The counter reading returns to "0:00" and this point is memorized.



The tape will be automatically rewound to the "0:00" point and the recording mode is canceled.

Note:

The tape will stop at the point slightly ahead of the "0:00" point (around – 0:01).

REC RETURN OPERATION — To return to the point at which the recording previously started

During recording



- If the ► PLAY button is pressed during recording, rec return operation automatically rewinds the tape to the point where the ► PLAY button was previously pressed.

CASSETTE TAPES

CASSETTE TAPES

There are many different types of cassette tapes available. However, they all conform to standard specifications so any brand may be used with the deck.

● Classification of Cassette Tapes by Formulation

Cassette tapes are available in four basic types depending on their formulation, or type of magnetic material and manufacturing process. These four types are commonly known as Normal (Type I/NORM), Chrome (Type II/HIGH $\langle\text{CrO}_2\rangle$), Ferrichrome (Type III/FeCr), and Metal (Type IV/METAL), and they each require specific tape deck adjustments for optimum performance.

- * YAMAHA does not recommend the use of 120-minute length cassettes since the extreme thinness of the tape makes them susceptible to mechanical and recording problems.

AUTO TAPE SELECTOR DETECTION SLOTS

The deck has a built-in Auto Tape Selector which automatically adjusts for the proper bias, level and equalization according to the tape formulation — all you have to do is to load a cassette and the Auto Tape Selector does the rest.

The Auto Tape Selector determines what type of tape is loaded by sensing detector slots on top of the tape shell. Each tape formulation has its own characteristic hole markings standardized by the tape industry.

- Early model Metal (Type IV/METAL) tape formulation cassette shells do not have the slots for Auto Tape Selector operation. As a result, early model Metal type tapes recorded on another deck will be played back with the deck at the Chrome (Type II/HIGH $\langle\text{CrO}_2\rangle$) settings. YAMAHA does not recommend recording with this kind of tape.
- The deck does not have the required setting for Ferrichrome (Type III/FeCr) tape, since this tape formulation is not widely used. Should you use a Ferrichrome tape, it will be recorded and played back at the Normal (Type I/NORM) settings, which will result in an unnatural high frequency emphasis. This effect may be compensated for somewhat with the auto tape tuning operation or by using the PLAY TRIM tone control and/or the tone controls of your amplifier/receiver during playback.

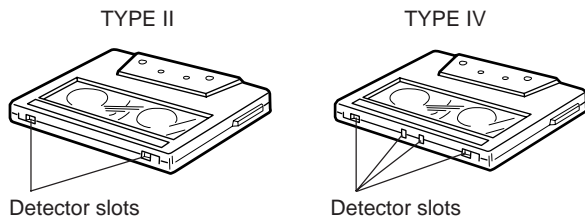

PROTECTING YOUR RECORDINGS

All cassette tapes are provided with erasure protection holes to prevent accidental erasure of recorded contents. There is a small tab covering the hole on each side of the cassette, and it should be broken off after recording on the tape. Without this tab covering the hole, it is impossible to record onto that tape. Thus, you can safely protect a recording for as long as you wish without fear of accidental erasure. Should you wish to use a cassette tape protected in this way for recording, simply covering the hole with adhesive tape will permit erasure and re-recording.

- When using Chrome (Type II/HIGH $\langle\text{CrO}_2\rangle$) or Metal (Type IV/METAL) tapes, make sure you do not cover the hole intended for the Auto Tape Selector operation.

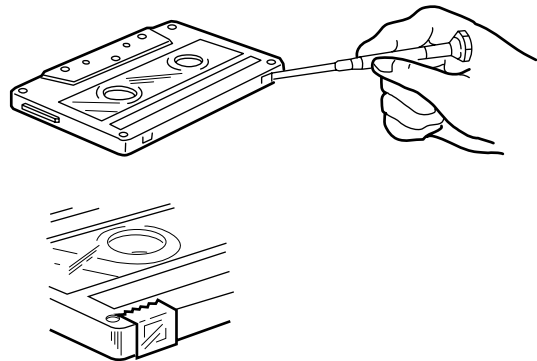

TAKING UP SLACK IN THE TAPE

As a precaution against tape entanglement and damage, remove any slack in the tape before inserting cassettes into the deck. This is accomplished by inserting a pencil, pen or similar object into one of the spools and gently winding it until all the slack is removed. You do not have to wind it too tightly.

Be careful not to touch the tape part itself. It is very delicate and touching it may damage the tape and its recorded contents.

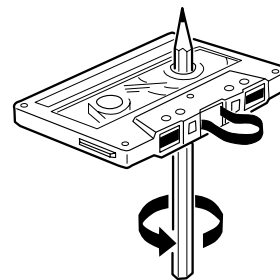

STORING CASSETTES

After putting a cassette tape back into its case, store it in a location away from exposure to direct sunlight, humidity, high temperatures, and magnetic fields (away from television sets, speakers, etc.). High temperatures and humidity will damage the tape itself, while exposure to magnetic fields may cause a loss of recorded material. Avoid touching the tape surface with your fingers, since dirt or finger oil will contaminate the deck's heads.

MAINTENANCE

CLEANING OF THE TAPE PATH

Continued high quality performance of your deck is dependent upon periodic cleaning of the heads, capstan, pinch roller, and all surfaces over which the tape travels. Normal use will cause an accumulation of dirt and dust on the heads, capstans, and pinch rollers. This can lead to poor sound quality, drop outs (intervals with no sound), unsteady tape speed, loss of high frequency response, etc. Thus, clean the heads and all surfaces over which the tape travels with a commercially available cleaning cassette.

DEMAGNETIZATION

After 20-30 hours of use, enough residual magnetism will build up on the heads to cause poor high frequency reproduction. At this time you should use a commercially available head demagnetizer.

- When demagnetizing the heads, be sure to follow the instructions of the head demagnetizer carefully.

OPTIONAL REMOTE CONTROL TRANSMITTER

With the optional remote control transmitter RS-KX1, you can operate this unit at your listening position. For details, refer to the instruction manual supplied with the remote control transmitter.

REMOTE CONTROL OPERATION RANGE

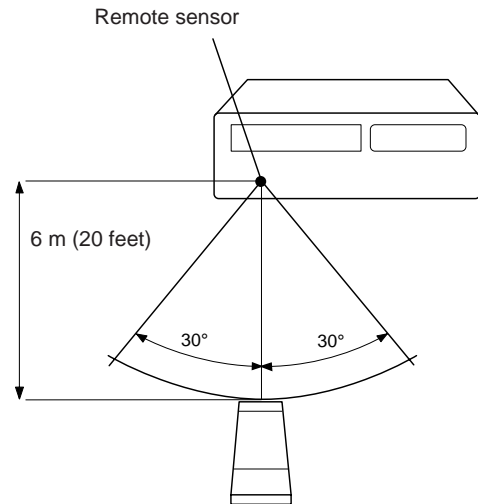
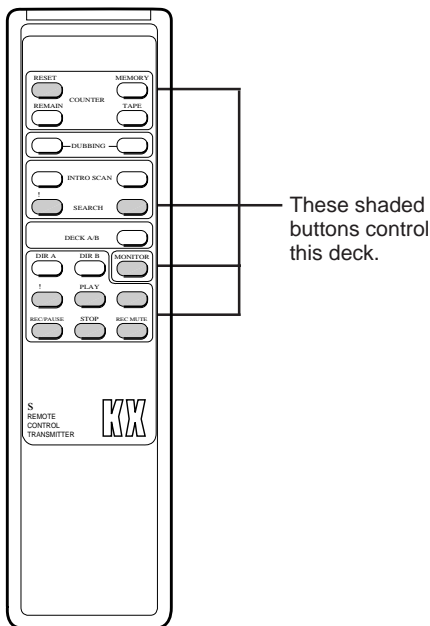

TROUBLESHOOTING

If your cassette deck fails to operate normally, check the following table. It lists common operating errors and simple measures which you can take to correct the problem. If it cannot be corrected, or the symptom is not listed, disconnect the deck's power cord and contact your authorized YAMAHA dealer or service center for help.

Fault	Cause	Cure
Tape doesn't move in recording or playback.	<ul style="list-style-type: none"> ● Power plug is not properly plugged in. ● End of tape. ● Cassette shell is warped or damaged. 	<ul style="list-style-type: none"> ● Reinsert plug properly. ● Rewind tape or flip it over. ● Do not play damaged tapes.
REC/PAUSE button fails to function.	<ul style="list-style-type: none"> ● No cassette tape is loaded. ● Protective tabs are broken off. 	<ul style="list-style-type: none"> ● Load a cassette tape. ● Change tape or cover protective hole with adhesive tape.
Sounds become faint and sometimes inaudible.	<ul style="list-style-type: none"> ● Head is dirty. ● Head is magnetized. ● Tape is damaged or of poor quality. 	<ul style="list-style-type: none"> ● Clean head. ● Demagnetize head using head demagnetizer. ● Change to a different tape.
Recorded sound is distorted.	<ul style="list-style-type: none"> ● Tape is bad (stretched or deformed, etc.). ● Cassette shell is warped. ● Recording level is too high. 	<ul style="list-style-type: none"> ● Replace with a fresh tape. ● A warped cassette shell cannot be fixed. Replace with another tape and test. ● Check input level with peak level meter and use lower rec level when recording.
Tape is playing back, but no sound is heard.	<ul style="list-style-type: none"> ● Faulty connection between deck and stereo amplifier/receiver. 	<ul style="list-style-type: none"> ● Check and secure connections.
Excessive noise.	<ul style="list-style-type: none"> ● Head is dirty. ● Head is magnetized. ● Worn out or poor quality tape. ● Connection(s) improperly made. ● Affected by external electrical noise. 	<ul style="list-style-type: none"> ● Clean head. ● Demagnetize head with head demagnetizer. ● Change to better tape. ● Check input and output connections and reinsert properly. ● Move away from electrical appliances (TV, fluorescent light, electric blanket, etc.).
Excessive wow (wavering of the sound).	<ul style="list-style-type: none"> ● Dirty capstan, pinch roller, etc., or poor tape. ● Tape is wound unevenly. 	<ul style="list-style-type: none"> ● Clean capstan or pinch roller, or change to better tape. ● Rewind tape.
Tape stops in the middle of recording or playback.	<ul style="list-style-type: none"> ● Slack tape, or tape spillage wound around capstan. 	<ul style="list-style-type: none"> ● Remove the wound tape carefully. To avoid this, insert pencil in hole in cassette shell and turn to take up slack in advance.
Fails to record.	<ul style="list-style-type: none"> ● REC LEVEL control is set too low. ● Protective tabs are broken off. 	<ul style="list-style-type: none"> ● Adjust REC LEVEL control. ● Change tape or cover protective hole with adhesive tape.
Search does not operate.	<ul style="list-style-type: none"> ● Recorded section is too short. ● Recorded section has low-level portions. ● Conversation, etc. has been recorded. 	<ul style="list-style-type: none"> ● Blank sections must be at least 4 seconds long.
High frequencies in the playback sound are emphasized and unpleasant to listen to, and noise level (hiss) is also high.	<ul style="list-style-type: none"> ● Dolby NR-recorded tape is played back in OFF position. 	<ul style="list-style-type: none"> ● Playback in appropriate Dolby NR position.

Fault	Cause	Cure
Playback sound is muffled and high frequencies are inaudible.	<ul style="list-style-type: none"> ● A tape recorded without Dolby NR is played back with Dolby NR on. ● Heads are dirty. ● Heads are magnetized. 	<ul style="list-style-type: none"> ● Playback in OFF position. ● Clean heads and carry out demagnetization with head demagnetizer.
When playing back tapes recorded on other decks, meter deflections are greater (smaller) than when recording.	<ul style="list-style-type: none"> ● Basic levels are different for different cassette decks. 	<ul style="list-style-type: none"> ● This is not a fault.

SPECIFICATIONS

Track Configuration 4 track, 2 channel stereo

Motor DC servo motor (capstan)
 DC motor (reel)
 DC motor (tray)

Head Recording: hard permalloy
 Playback: hard permalloy
 Erase: double-gap Ferrite

Rapid Transport 95 sec. (C-60)

Wow and Flutter
W.RMS less than 0.05%
W.Peak less than ±0.08%

Signal-to-Noise Ratio
(Dolby NR off) better than 60 dB
(Dolby B NR on) better than 68 dB
(Dolby C NR on) better than 76 dB

Frequency Response
Normal tape (-20 dB) 20 - 17,000 Hz ±3 dB
High (CrO₂) tape (-20 dB) 20 - 18,000 Hz ±3 dB
Metal tape (-20 dB) 20 - 20,000 Hz ±3 dB

Harmonic Distortion
Normal tape less than 0.8%
High (CrO₂) tape less than 0.8%
Metal tape less than 0.8%

Input Sensitivity/Impedance
Line 100 mV/50 k-ohms

Output Level
Line 570 mV/2.2 k-ohms

Channel Separation (1 kHz) 40 dB
Cross Talk (125 Hz) 55 dB

GENERAL

Power Supplies
Europe model 230 V, 50 Hz
U.K. model and Australia model 240 V, 50 Hz
General model 110/120/220/240 V, 50/60 Hz

Power Consumption 16 W
 5 W(POWER OFF)

Dimensions (W x H x D) 280 x 119 x 360 mm
 (11 x 4-11/16" x 14-3/16")

Weight 4.8 kg (10 lbs. 9 oz.)

Accessories
Connecting cords 2

* Specifications subject to change without notice.

YAMAHA

YAMAHA ELECTRONICS CORPORATION, USA 6660 ORANGETHORPE AVE., BUENA PARK, CALIF. 90620, U.S.A.
YAMAHA CANADA MUSIC LTD. 135 MILNER AVE., SCARBOROUGH, ONTARIO M1S 3R1, CANADA
YAMAHA ELECTRONIK EUROPA G.m.b.H. SIEMENSSTR. 22-34, D-2084 RELINGEN BEI HAMBURG, F.R. OF GERMANY
YAMAHA ELECTRONIQUE FRANCE S.A. 17 RUE DES CAMPANULES, LOGNES 77321 MARNE LA VALLEE CEDEX 2 FRANCE
YAMAHA ELECTRONICS (UK) LTD. YAMAHA HOUSE, 200 RICKMANSWORTH ROAD WATFORD, HERTS WD1 7JS, ENGLAND
YAMAHA SCANDINAVIA A.B. J A WETTERGRENS GATA 1, BOX 30053, 400 43 VASTRA FRÖLUNDA, SWEDEN
YAMAHA MUSIC AUSTRALIA PTY, LTD. 17-33 MARKET ST., SOUTH MELBOURNE, 3205 VIC., AUSTRALIA

YAMAHA CORPORATION
V 332900