



RX-E600

Receiver

Récepteur



**OWNER'S MANUAL
MODE D'EMPLOI**

IMPORTANT SAFETY INSTRUCTIONS

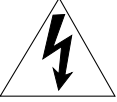

CAUTION
RISK OF ELECTRIC SHOCK
DO NOT OPEN



CAUTION: TO REDUCE THE RISK OF ELECTRIC SHOCK, DO NOT REMOVE COVER (OR BACK). NO USER-SERVICEABLE PARTS INSIDE. REFER SERVICING TO QUALIFIED SERVICE PERSONNEL.

• Explanation of Graphical Symbols

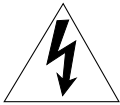

The lightning flash with arrowhead symbol, within an equilateral triangle, is intended to alert you to the presence of uninsulated “dangerous voltage” within the product’s enclosure that may be of sufficient magnitude to constitute a risk of electric shock to persons.



The exclamation point within an equilateral triangle is intended to alert you to the presence of important operating and maintenance (servicing) instructions in the literature accompanying the appliance.

WARNING

TO REDUCE THE RISK OF FIRE OR ELECTRIC SHOCK, DO NOT EXPOSE THIS UNIT TO RAIN OR MOISTURE.

- 1 Read Instructions – All the safety and operating instructions should be read before the product is operated.
- 2 Retain Instructions – The safety and operating instructions should be retained for future reference.
- 3 Heed Warnings – All warnings on the product and in the operating instructions should be adhered to.
- 4 Follow Instructions – All operating and use instructions should be followed.
- 5 Cleaning – Unplug this product from the wall outlet before cleaning. Do not use liquid cleaners or aerosol cleaners. Use a damp cloth for cleaning.
- 6 Attachments – Do not use attachments not recommended by the product manufacturer as they may cause hazards.
- 7 Water and Moisture – Do not use this product near water – for example, near a bath tub, wash bowl, kitchen sink, or laundry tub; in a wet basement; or near a swimming pool; and the like.
- 8 Accessories – Do not place this product on an unstable cart, stand, tripod, bracket, or table. The product may fall, causing serious injury to a child or adult, and serious damage to the product. Use only with a cart, stand, tripod, bracket, or table recommended by the manufacturer, or sold with the product. Any mounting of the product should follow the manufacturer’s instructions, and should use a mounting accessory recommended by the manufacturer.
- 9 A product and cart combination should be moved with care. Quick stops, excessive force, and uneven surfaces may cause the product and cart combination to overturn. 
- 10 Ventilation – Slots and openings in the cabinet are provided for ventilation and to ensure reliable operation of the product and to protect it from overheating, and these openings must not be blocked or covered. The openings should never be blocked by placing the product on a bed, sofa, rug, or other similar surface. This product should not be placed in a built-in installation such as a bookcase or rack unless proper ventilation is provided or the manufacturer’s instructions have been adhered to.
- 11 Power Sources – This product should be operated only from the type of power source indicated on the marking label. If you are not sure of the type of power supply to your home, consult your product dealer or local power company. For products intended to operate from battery power, or other sources, refer to the operating instructions.
- 12 Grounding or Polarization – This product may be equipped with a polarized alternating current line plug (a plug having one blade wider than the other). This plug will fit into the power outlet only one way. This is a safety feature. If you are unable to insert the plug fully into the outlet, try reversing the plug. If the plug should still fail to fit, contact your electrician to replace your obsolete outlet. Do not defeat the safety purpose of the polarized plug.
- 13 Power-Cord Protection – Power-supply cords should be routed so that they are not likely to be walked on or pinched by items placed upon or against them, paying particular attention to cords at plugs, convenience receptacles, and the point where they exit from the product.
- 14 Lightning – For added protection for this product during a lightning storm, or when it is left unattended and unused for long periods of time, unplug it from the wall outlet and disconnect the antenna or cable system. This will prevent damage to the product due to lightning and power-line surges.
- 15 Power Lines – An outside antenna system should not be located in the vicinity of overhead power lines or other electric light or power circuits, or where it can fall into such power lines or circuits. When installing an outside antenna system, extreme care should be taken to keep from touching such power lines or circuits as contact with them might be fatal.
- 16 Overloading – Do not overload wall outlets, extension cords, or integral convenience receptacles as this can result in a risk of fire or electric shock.
- 17 Object and Liquid Entry – Never push objects of any kind into this product through openings as they may touch dangerous voltage points or short-out parts that could result in a fire or electric shock. Never spill liquid of any kind on the product.
- 18 Servicing – Do not attempt to service this product yourself as opening or removing covers may expose you to dangerous voltage or other hazards. Refer all servicing to qualified service personnel.
- 19 Damage Requiring Service – Unplug this product from the wall outlet and refer servicing to qualified service personnel under the following conditions:
 - a) When the power-supply cord or plug is damaged,
 - b) If liquid has been spilled, or objects have fallen into the product,
 - c) If the product has been exposed to rain or water,

IMPORTANT SAFETY INSTRUCTIONS

- d) If the product does not operate normally by following the operating instructions. Adjust only those controls that are covered by the operating instructions as an improper adjustment of other controls may result in damage and will often require extensive work by a qualified technician to restore the product to its normal operation,
 - e) If the product has been dropped or damaged in any way, and
 - f) When the product exhibits a distinct change in performance - this indicates a need for service.
- 20 Replacement Parts – When replacement parts are required, be sure the service technician has used replacement parts specified by the manufacturer or have the same characteristics as the original part. Unauthorized substitutions may result in fire, electric shock, or other hazards.
- 21 Safety Check – Upon completion of any service or repairs to this product, ask the service technician to perform safety checks to determine that the product is in proper operating condition.
- 22 Wall or Ceiling Mounting – The unit should be mounted to a wall or ceiling only as recommended by the manufacturer.
- 23 Heat – The product should be situated away from heat sources such as radiators, heat registers, stoves, or other products (including amplifiers) that produce heat.

- 24 Outdoor Antenna Grounding – If an outside antenna or cable system is connected to the product, be sure the antenna or cable system is grounded so as to provide some protection against voltage surges and built-up static charges. Article 810 of the National Electrical Code, ANSI/NFPA 70, provides information with regard to proper grounding of the mast and supporting structure, grounding of the lead-in wire to an antenna discharge unit, size of grounding conductors, location of antenna discharge unit, connection to grounding electrodes, and requirements for the grounding electrode.

EXAMPLE OF ANTENNA GROUNDING

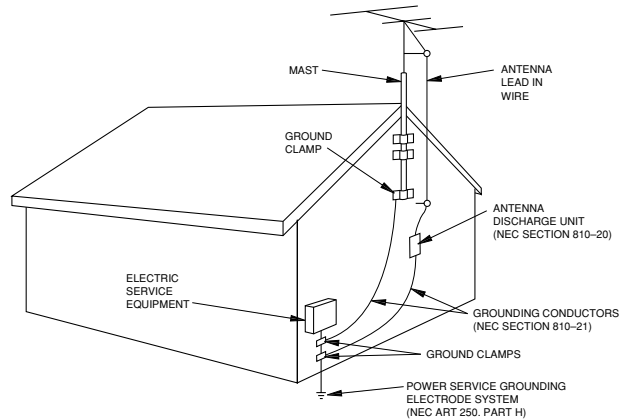

NEC – NATIONAL ELECTRICAL CODE

Note to CATV system installer:

This reminder is provided to call the CATV system installer's attention to Article 820-40 of the NEC that provides guidelines for proper grounding and, in particular, specifies that the cable ground shall be connected to the grounding system of the building, as close to the point of cable entry as practical.

FCC INFORMATION (for US customers)

1. IMPORTANT NOTICE : DO NOT MODIFY THIS UNIT!

This product, when installed as indicated in the instructions contained in this manual, meets FCC requirements. Modifications not expressly approved by Yamaha may void your authority, granted by the FCC, to use the product.

2. **IMPORTANT :** When connecting this product to accessories and/or another product use only high quality shielded cables. Cable/s supplied with this product **MUST** be used. Follow all installation instructions. Failure to follow instructions could void your FCC authorization to use this product in the USA.

3. **NOTE :** This product has been tested and found to comply with the requirements listed in FCC Regulations, Part 15 for Class "B" digital devices. Compliance with these requirements provides a reasonable level of assurance that your use of this product in a residential environment will not result in harmful interference with other electronic devices.
- This equipment generates/uses radio frequencies and, if not installed and used according to the instructions found in the users manual, may cause interference harmful to the operation of other electronic devices.

Compliance with FCC regulations does not guarantee that interference will not occur in all installations. If this product is found to be the source of interference, which can be determined by turning the unit "OFF" and "ON", please try to eliminate the problem by using one of the following measures:

Relocate either this product or the device that is being affected by the interference.

Utilize power outlets that are on different branch (circuit breaker or fuse) circuits or install AC line filter/s.

In the case of radio or TV interference, relocate/reorient the antenna. If the antenna lead-in is 300 ohm ribbon lead, change the lead-in to coaxial type cable.

If these corrective measures do not produce satisfactory results, please contact the local retailer authorized to distribute this type of product. If you can not locate the appropriate retailer, please contact Yamaha Electronics Corp., U.S.A. 6660 Orangethorpe Ave, Buena Park, CA 90620.

The above statements apply **ONLY** to those products distributed by Yamaha Corporation of America or its subsidiaries.

CAUTION: READ THIS BEFORE OPERATING THIS UNIT

- 1 To assure the finest performance, please read this manual carefully. Keep it in a safe place for future reference.
- 2 Install this unit in a well ventilated, cool, dry, clean place away from direct sunlight, heat sources, vibration, dust, moisture or cold. In a cabinet, allow about 10 cm (4 in.) of free space all around RX-E600 for adequate ventilation.
- 3 Locate this unit away from other electrical appliances, motors, or transformers to avoid humming sounds.
- 4 Do not expose this unit to sudden temperature changes from cold to hot, nor locate this unit in an environment with high humidity (i.e., a room with a humidifier) to prevent condensation inside this unit, which may cause an electrical shock, fire, damage to this unit, and/or personal injury.
- 5 Avoid installing this unit in a location where foreign objects may fall onto this unit or where this unit may be exposed to liquid dripping or splashing. On the top of this unit, do not place:
 - Other components, as they may cause damage and/or discoloration on the surface of this unit.
 - Burning objects (i.e., candles), as they may cause fire, damage to this unit, and/or personal injury.
 - Containers with liquid in them, as they may fall, spilling the liquid and causing an electrical shock to the user and/or damage to this unit.
- 6 Do not cover this unit with a newspaper, tablecloth, curtain, etc. in order not to obstruct heat radiation. If the temperature inside this unit rises, it may cause fire, damage to this unit, and/or personal injury.
- 7 Do not plug in this unit to a wall outlet until all connections are complete.
- 8 Do not operate this unit upside-down. It may overheat, possibly causing damage.
- 9 Do not use excessive force on switches, knobs and/or cords.
- 10 When disconnecting the power cord from the wall outlet, grasp the plug; do not pull the cord.
- 11 Do not clean this unit with chemical solvents; this might damage the finish. Use a clean, dry cloth.
- 12 Use only the voltage specified on this unit. Using this unit with a higher voltage than specified is dangerous and may cause fire, damage to this unit, and/or personal injury. YAMAHA will not be held responsible for any damage resulting from use of this unit with a voltage other than as specified.
- 13 To prevent damage by lightning, disconnect the power cord from the wall outlet during an electrical storm.
- 14 Do not attempt to modify or fix this unit. Contact qualified YAMAHA service personnel when any service is needed. The cabinet should never be opened for any reason.
- 15 When not planning to use this unit for long periods of time (i.e., vacation), disconnect the AC power plug from the wall outlet.
- 16 Be sure to read the “Troubleshooting” section on common operating errors before concluding that this unit is faulty.
- 17 Before moving this unit, press STANDBY/ON to set the unit in standby mode, then disconnect the AC power plug from the wall outlet.
- 18 **VOLTAGE SELECTOR** (General model only)

The VOLTAGE SELECTOR on the rear panel of this unit must be set for your local main voltage BEFORE plugging into the AC main supply. Voltages are 110/120/220/230-240 V AC, 50/60 Hz.

WARNING

TO REDUCE THE RISK OF FIRE OR ELECTRIC SHOCK, DO NOT EXPOSE THIS UNIT TO RAIN OR MOISTURE.

The unit is not disconnected from the AC power source as long as it is connected to the wall outlet, even if this unit itself is turned off. This state is called the standby mode. In this state, this unit is designed to consume a very small quantity of power.

FOR CANADIAN CUSTOMERS

To prevent electric shock, match wide blade of plug to wide slot and fully insert. This Class B digital apparatus complies with Canadian ICES-003.

(U.S.A., Canada and General models)
The nameplate is located on the bottom of the unit.

IMPORTANT

Please record the serial number of this unit in the space below.

MODEL:

Serial No.:

The serial number is located on the bottom of the unit. Retain this Owner's Manual in a safe place for future reference.

We Want You Listening For A Lifetime

YAMAHA and the Electronic Industries Association's Consumer Electronics Group want you to get the most out of your equipment by playing it at a safe level. One that lets the sound come through loud and clear without annoying blaring or distortion – and, most importantly, without affecting your sensitive hearing.

Since hearing damage from loud sounds is often undetectable until it is too late, YAMAHA and the Electronic Industries Association's Consumer Electronics Group recommend you to avoid prolonged exposure from excessive volume levels.



FEATURES

- Minimum RMS output power per channel 40 W + 40 W (6Ω, 20 Hz to 20 kHz, 0.1% THD)
- System remote control
- 40-station FM/AM preset tuning
- SUBWOOFER output terminal

The receiver (RX-E600) and DVD player (DVD-E600) are the main units of the YAMAHA Piano Craft Series. You can upgrade the system by adding the cassette deck (KX-E300) and MD recorder (MDX-E300)*.

* MD recorder (MDX-E300) may not be available for some areas.

CONTENTS

SUPPLIED ACCESSORIES 2

GETTING STARTED

| | |
|--|---|
| Remote control | 3 |
| Connecting the speakers and antennas | 4 |
| Connecting the system | 5 |
| Setting the clock | 6 |

NAMES OF BUTTONS AND CONTROLS

| | |
|----------------------|---|
| Front panel | 7 |
| Display | 7 |
| Remote control | 8 |

BASIC OPERATIONS

| | |
|-----------------------------|---|
| Listening to a source | 9 |
|-----------------------------|---|

TUNING

| | |
|------------------------------|----|
| Listening to the radio | 10 |
| Presetting stations | 11 |

USING THE BUILT-IN TIMER

| | |
|--------------------------------|----|
| Before using the timer | 12 |
| Timer play and recording | 12 |
| Sleep timer | 13 |

SYSTEM CONTROL

| | |
|------------------------------------|----|
| Controlling other components | 14 |
| Before recording | 16 |
| Dubbing setting | 16 |

ADDITIONAL INFORMATION

| | |
|-----------------------|----|
| Troubleshooting | 17 |
| Specifications | 19 |

SUPPLIED ACCESSORIES

After unpacking, check that the following parts are contained.

- Remote control

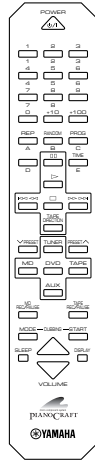

- Batteries (AA, R6, UM-3)

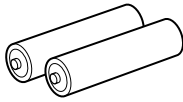

- AM loop antenna

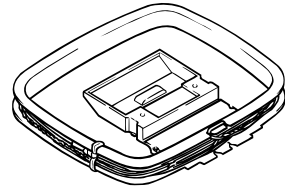

- Indoor FM antenna
(U.S.A., Canada, China,
Korea and General
models)

(Europe, U.K., and
Australia models)

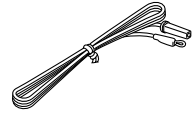
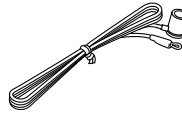

Remote control

The remote control for the RX-E600 also controls the DVD-E600 DVD player, KX-E300 cassette deck, and the MDX-E300 MD recorder. Operating buttons for each unit are explained on the pages below:

| | |
|-------------------------|------|
| Receiver, RX-E600: | P.8 |
| DVD player, DVD-E600: | P.14 |
| Cassette deck, KX-E300: | P.15 |
| MD recorder, MDX-E300: | P.15 |

Battery installation

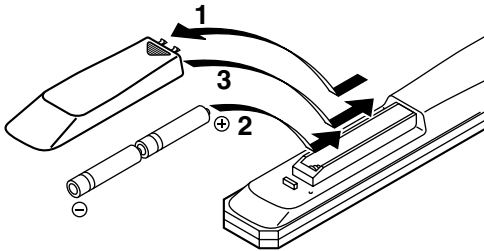

- 1 Remove the battery compartment cover.
- 2 Insert batteries into the battery compartment.
- 3 Replace the battery compartment cover.

Battery replacement

If you find that the remote control must be used closer to the main unit than usual, the batteries are weak. Replace batteries with new ones.

Notes

- Use only AA, R6, UM-3 batteries for replacement.
- Be sure the polarities are correct. (See the illustration inside the battery compartment.)
- Remove the batteries if the remote control will not be used for an extended period of time.
- If batteries leak, dispose of them immediately. Avoid touching the leaked material or letting it come in contact with clothing, etc. Clean the battery compartment thoroughly before installing new batteries.

Remote control operation range

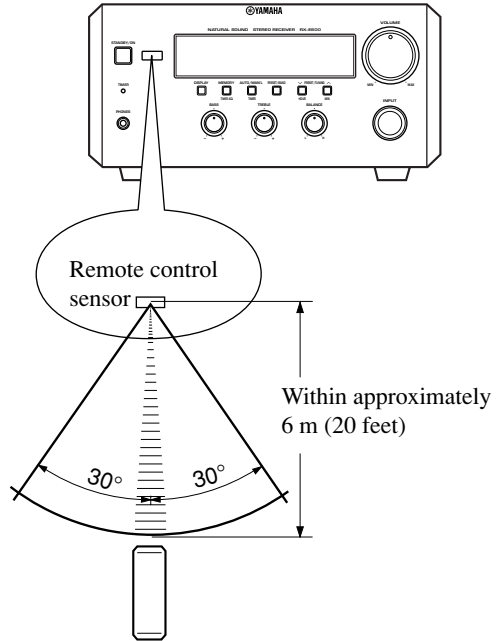

Notes

- There should be no large obstacles between the remote control and the main unit.
- Strong light (especially light from inverter-type fluorescent lamps etc) on the remote control sensor may impede the functioning of the remote control. In this case, reposition the main unit to avoid direct lighting.

Removing the protection sheet

The remote control is shipped with a protection sheet to prevent the surface from being scratched during transportation.

When removing the sheet, first put adhesive tape on an edge of the remote control so that the tape sticks to the sheet. Then peel the sheet off with the tape.

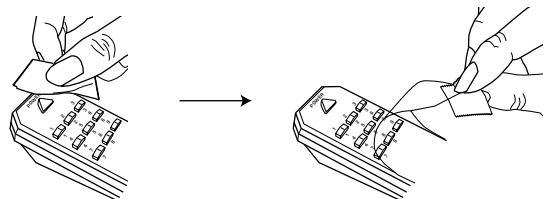

Note

- Do not scratch the remote control surface when peeling the sheet off.

Connecting the speakers and antennas

Do not connect the AC power cord to the wall outlet until all connections have been completed.

Follow the steps as shown below to connect the system using the supplied cords and accessories. Be sure all connections are made correctly, that is to say L (left) to L, R (right) to R, “+” to “+” and “-” to “-”.

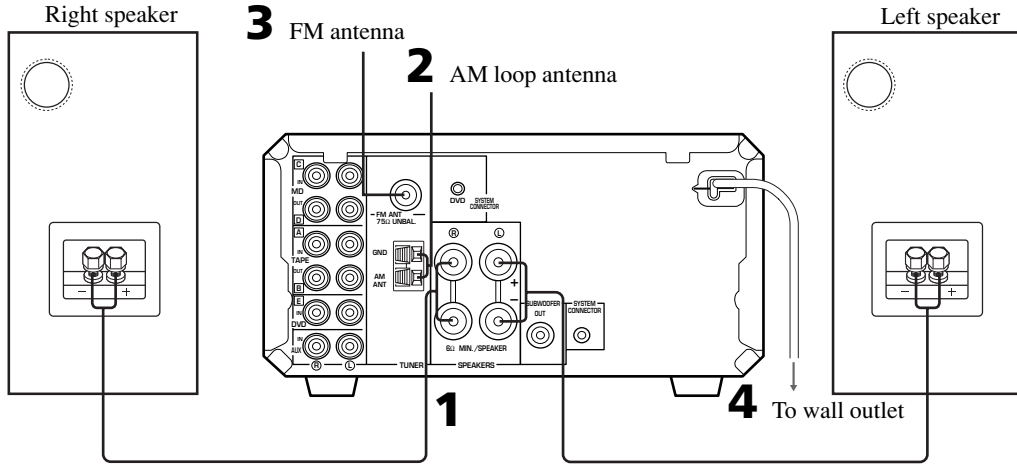

- 1** Connect the Speakers.
- ① Unscrew the knob.
 - ② Remove approx. 10 mm (0.4") of insulation from each of the speaker wires and insert the bare wire into the terminal.
 - ③ Tighten the knob to secure the wire.

Red: positive(+)
Black: negative(-)

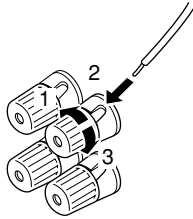

- 3** Connect the FM Antenna.

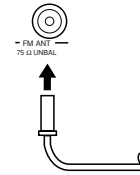

- 4** Connect the AC power cord to a wall outlet.

- 2** Connect the AM Antenna.
Set up the AM loop antenna, then connect it.

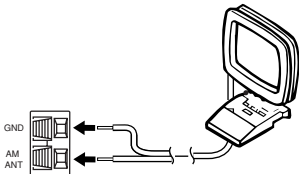
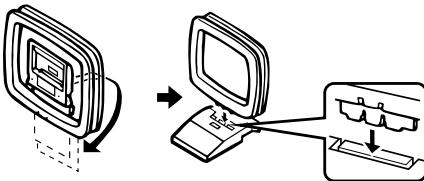

Notes

- Use external FM/AM antennas if you need better reception. Consult your dealer.
- The AM loop antenna should be placed apart from the main unit. The antenna may be hung on a wall.

To connect the subwoofer (optional)

You can reinforce the bass frequencies by adding a subwoofer (optional). Connect the **SUBWOOFER OUT** terminal of the unit to the **INPUT** terminal of the subwoofer.

Connecting the system

Connecting the RX-E600 and the DVD-E600

- 1 Connect **[E]** to **[E]** using the Audio pin cable.
Insert the plugs into the jacks of the same color.
- 2 Connect the **SYSTEM CONNECTOR (DVD)** of the RX-E600 and the **SYSTEM CONNECTOR (RECEIVER)** of the DVD-E600 with a system control cable (supplied with the DVD-E600).
*The other **SYSTEM CONNECTOR** of the RX-E600 is for connecting the MDX-E300 or KX-E300.
- 3 Connect the AC power plug of the DVD-E600 to **AC OUTLET** of the RX-E600.
This configuration allows you to turn all components in the system on and off with one touch, and reduces the standby power consumption of the DVD-E600.

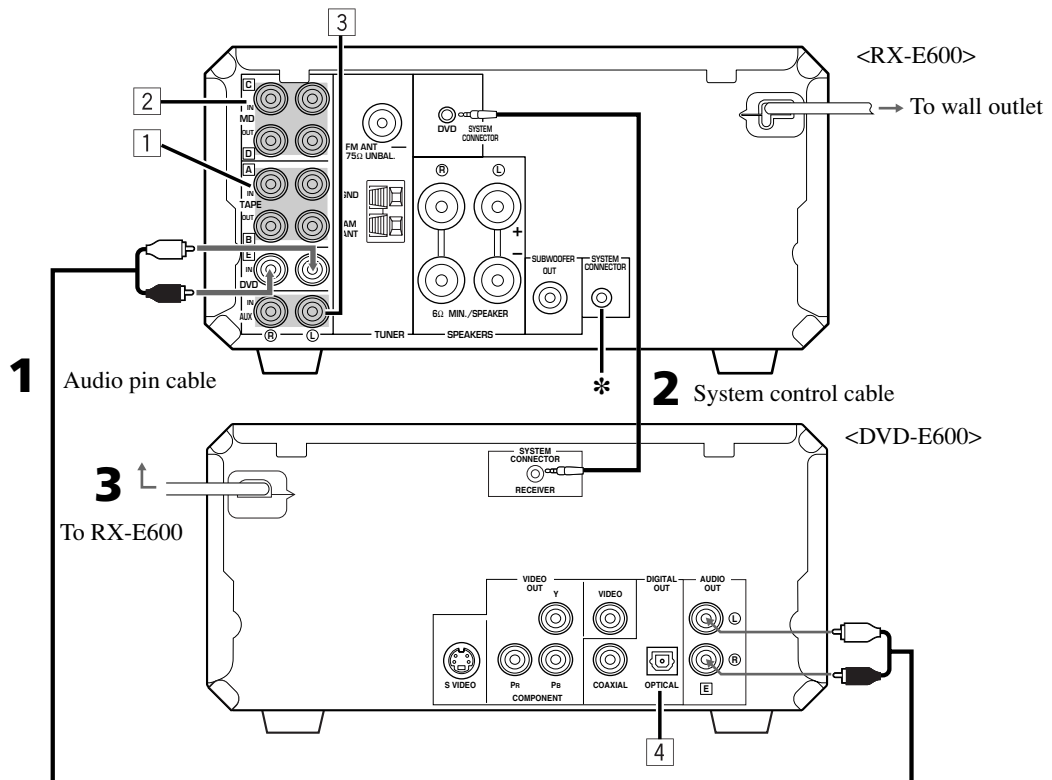

Adding KX-E300 and MDX-E300 to the above system

(For details, refer to the owner's manual supplied with the respective component.)

- 1 Connect **[A]** and **[B]** of RX-E600 to **[A]** and **[B]** of KX-E300.
- 2 Connect **[C]** and **[D]** of RX-E600 to **[C]** and **[D]** of MDX-E300.
- 3 Connect an external component to the **AUX** terminal of RX-E600.
- 4 Connect **DIGITAL OPTICAL OUT** of DVD-E600 to **DIGITAL OPTICAL IN** of MDX-E300.

Take off the covers of the optical fiber cable plug, the **DIGITAL OPTICAL OUT** jack, and the **DIGITAL OPTICAL IN** jack before making digital connections. Be sure to replace the terminal's cover when the terminal on the rear panel is not being used, in order to protect from dust.

Caution

- Do not turn RX-E600 on until all connections between components have been completed.
- Do not connect or disconnect the system control cable and/or power cord while the system components are turned on.

Setting the clock

You must set the clock before you use the timer functions. The clock is based on a 12-hour system for U.S. and Canada models, and 24-hour system for Australia model.

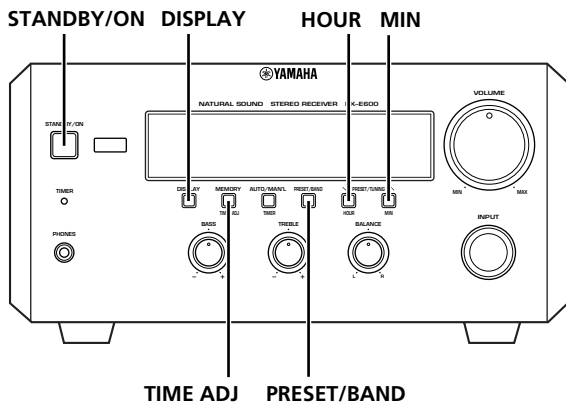

- 1** Turn on the power by pressing **STANDBY/ON** on the front panel, or **POWER** on the remote control.
- 2** While the power is on, press **DISPLAY** to display the time.
- 3** Press **HOUR** while holding **TIME ADJ** to advance the hour setting.
 - Press **HOUR** while holding **TIME ADJ** and **PRESET/BAND** to reverse the hour setting.
- 4** Press **MIN** while holding **TIME ADJ** to advance the minute setting.
 - Press **MIN** while holding **TIME ADJ** and **PRESET/BAND** to reverse the minute setting.

To display the clock

Press **DISPLAY**.

The current time appears for about 8 seconds, then the normal display returns. Some buttons and controls may not work while the current time is displayed.

Note

- In the event of a power failure or when the AC power cord is disconnected for more than five minutes, you must reset the clock.

Front panel

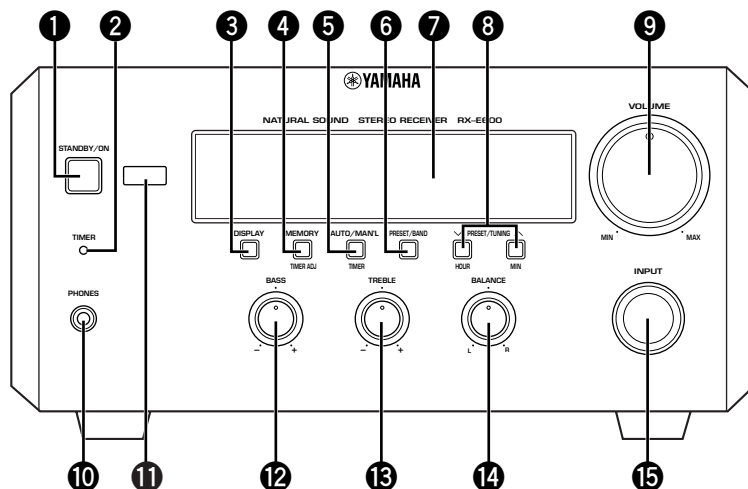

- ❶ **STANDBY/ON** (P.9)
- ❷ **TIMER** indicator (P.12)
- ❸ **DISPLAY** (P.12)
- ❹ **MEMORY/TIME ADJ** (P.6/P.11)
- ❺ **AUTO/MAN'L/TIMER** (P.10/P.12)
- ❻ **PRESET/BAND** (P.10)
- ❼ Display (P.7)
- ❽ **PRESET/TUNING** \wedge/\vee (P.10)
HOUR/MIN (P.6/P.12)
- ❾ **VOLUME** (P.9)
- ❿ **PHONES** (P.9)
- ⓫ Remote control sensor (P.3)
- ⓬ **BASS** (P.9)
- ⓭ **TREBLE** (P.9)
- ⓮ **BALANCE** (P.9)
- ⓯ **INPUT** (P.9)

Display

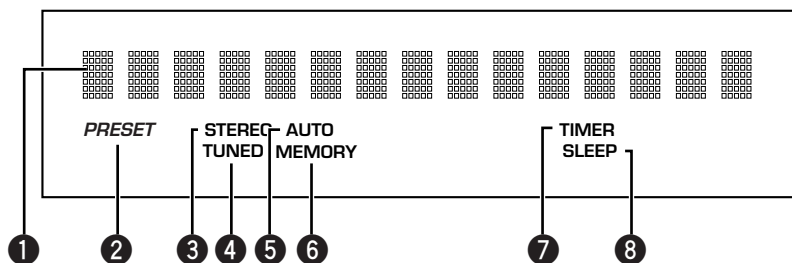

- ❶ Multi-information display
- ❷ **PRESET** indicator (P.11)
- ❸ **STEREO** indicator (P.10)
- ❹ **TUNED** indicator (P.10)
- ❺ **AUTO** indicator (P.10)
- ❻ **MEMORY** indicator (P.11)
- ❼ **TIMER** indicator (P.12)
- ❽ **SLEEP** indicator (P.13)

Remote control

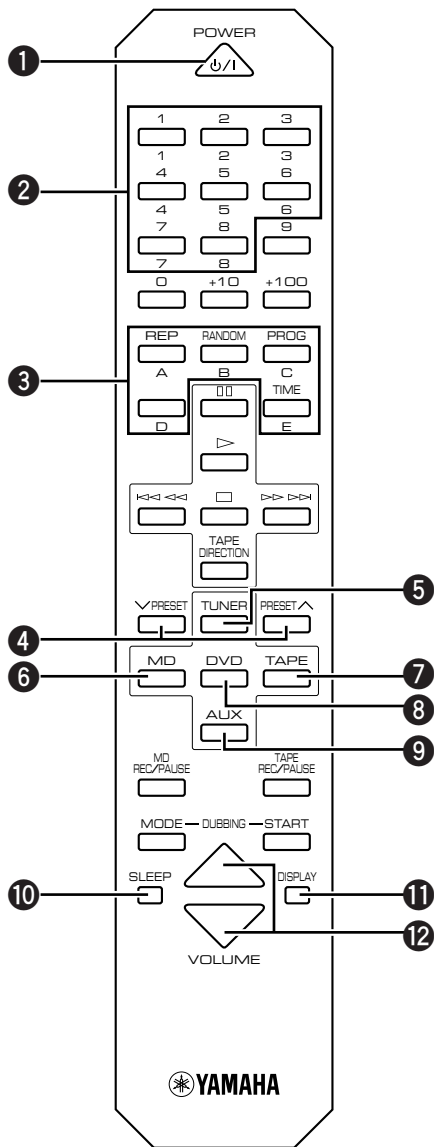

- ❶ **POWER** (P.9)
- ❷ **Preset numbers** (P.11)
- ❸ **A/B/C/D/E** (P.11)
- ❹ **PRESET** ^/√ (P.11)
- ❺ **TUNER** (RX-E600) (P.11)
- ❻ **MD input** (MDX-E300) (P.15)
- ❼ **TAPE input** (KX-E300) (P.15)
- ❽ **DVD input** (DVD-E600) (P.14)
- ❾ **AUX** (The equipment connected to the AUX terminal) (P.5)
- ❿ **SLEEP** (P.13)
- ⓫ **DISPLAY** (P.12)
- ⓬ **VOLUME** Δ/∇ (P.9)

Note

- ❺ - ❾ are operation buttons and input selectors for each component.

Listening to a source

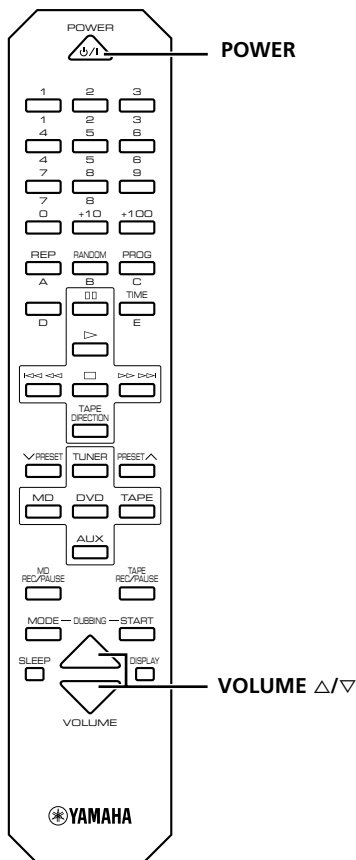
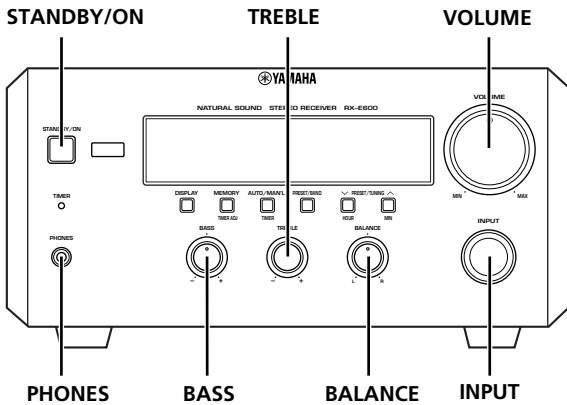

- 1** Set the volume to “MIN” by turning **VOLUME**.
- 2** Turn on the power by pressing **STANDBY/ON** on the front panel, or **POWER** on the remote control.
 - Piano Craft series components that have correct system connections made to RX-E600 can be controlled to turn to the on or standby mode by RX-E600. However, once the connected components are turned to the standby mode with their respective **STANDBY/ON** button, they cannot be controlled by RX-E600 **STANDBY/ON** button.
- 3** Select the desired input source by turning **INPUT** until a suitable source component name appears on the display.
 - When you operate the component connected to the **AUX** terminal, turn **INPUT** to select **AUX**.
- 4** Start playback on the source component. (Refer to the owner’s manual supplied with each selected component.)
- 5** Adjust the volume level by turning **VOLUME** on the front panel or pressing **VOLUME** Δ/∇ on the remote control.
- 6** If desired, adjust **BASS**, **TREBLE**, and **BALANCE**.
 - BASS:** Turn this control clockwise to increase (or counterclockwise to decrease) the low frequency response.
 - TREBLE:** Turn this control clockwise to increase (or counterclockwise to decrease) the high frequency response.
 - BALANCE:** Adjust the balance of the output volume from the left and right speakers to compensate for sound imbalance caused by the speaker location or listening room conditions.

When you use headphones

Connect the headphones to the **PHONES** jack. You can listen to the sound to be output from the main speakers through the headphones.

When you have finished using this unit

Press **STANDBY/ON** on the front panel again or **POWER** on the remote control to set this unit to the standby mode.

Auto standby function

This unit will automatically place itself in standby mode under the following conditions:

- When you select a component connected to this unit with a system control cable as an input source.
- The source component is stopped and has not been operated for 30 minutes.

Listening to the radio

You can find radio stations automatically and manually.

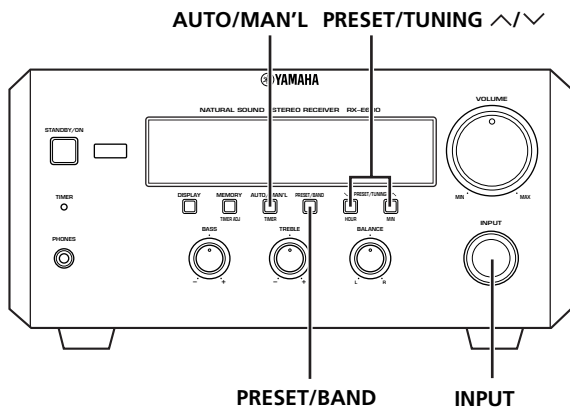

Manual tuning

- 1** Follow steps 1 and 2 described in “Automatic tuning.”
- 2** Press **AUTO/MAN'L** so that “AUTO” disappears from the display.
- 3** Press **PRESET/TUNING** ^ (for a higher frequency) or ∨ (for a lower frequency) to select your desired station.
 - The frequency changes incrementally each time you press **PRESET/TUNING**.

Automatic tuning

- 1** Select **TUNER** by turning **INPUT** so that the frequency of a radio station appears in the display.
- 2** Press **PRESET/BAND** to select the reception band. Do not select the preset tuning mode (in which “PRESET” appears on the display).
- 3** Press **AUTO/MAN'L** so that “AUTO” appears in the display.
- 4** Press **PRESET/TUNING** ^ (For a higher frequency) or ∨ (For a lower frequency).
- 5** The unit starts searching for a station.



When the unit finds a station, it stops searching and “TUNED” appears on the display.

- 6** If the station located is not the one you want, repeat steps 4 and 5 until you find a suitable station.

Notes

- If automatic tuning search does not find the desired station, try manual tuning as described next.
- When an FM stereo broadcast with sufficient signal strength is received, “STEREO” appears on the display and you can listen to stereo sound.

Presetting stations

The unit can store station frequencies selected using Automatic or Manual tuning as presets. Up to 40 stations can be stored. With this function, you can select any desired station by pressing the corresponding preset station number.

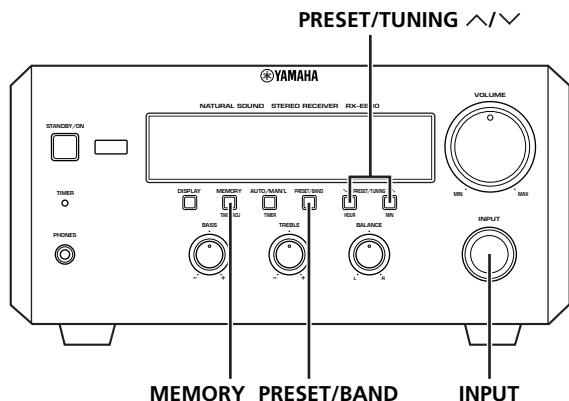

To preset stations manually

- 1 Tune in a desired station.
(Refer to the previous page for the tuning procedure.)
- 2 Press **MEMORY**.
- 3 Within about 5 seconds, use **PRESET/TUNING** \wedge/\vee to select a desired preset number. Continue pressing **PRESET/TUNING** \wedge/\vee to select the group of the preset stations (A, B, C, D, and E).

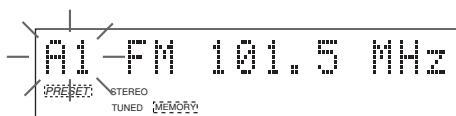

- 4 Press **MEMORY**.
 - “MEMORY”, “PRESET”, and preset number will appear on the display.

The arrow will appear for a second when it is preset.



- 5 Repeat steps 1 to 4 until all desired stations are preset.

Notes

- A new setting can be preset in place of a previous one.
- The preset stations are retained for a week after you disconnect the AC power cord or a power failure occurs.

To preset stations automatically

- 1 Select TUNER as input source by turning **INPUT**.
- 2 Press **MEMORY** for about 2 seconds.
 - The unit starts presetting stations, “AUTO” and “MEMORY” will flash on the display.

Received stations are stored to A1, A2...A8 sequentially. After 40 stations or all FM and AM stations are stored, the display will show the preset station A1.

To recall a preset station

Press **TUNER** and select the desired number by pressing **PRESET/BAND** and **PRESET/TUNING** \wedge/\vee on the front panel or **PRESET** \wedge/\vee , **A/B/C/D/E** and **1-8** on the remote control.

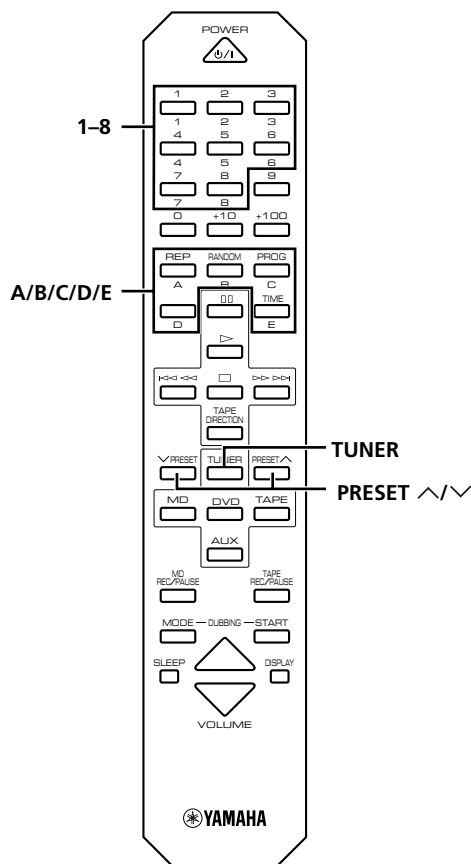

Before using the timer

If you want to use the cassette deck, KX-E300 or the MD Recorder, MDX-E300 for timer play or recording, you must first make the connections as shown in “Connecting the system” on page 5. For details, refer to the instructions supplied with the MDX-E300 or KX-E300.

Timer play and recording

By using the built-in timer, you can have the unit turn on at a specified time and begin playing or recording automatically. You can also specify the time at which you want the unit to turn off.

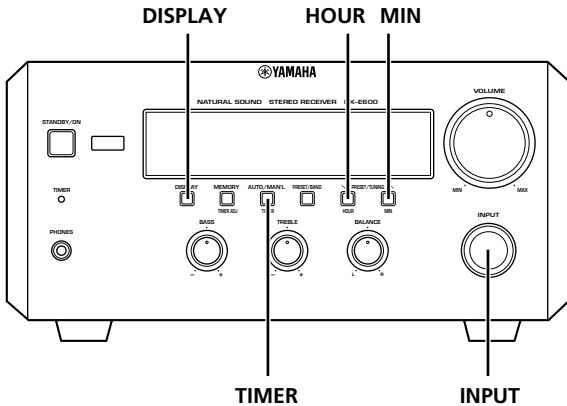

1 Press **DISPLAY**.
Whenever **DISPLAY** is pressed, the display mode changes as follows:

1. Clock Time (TIMER on/off mode)
If you have not set the clock yet “Set Clock” appears. You need to set the current time as described on page 6.
2. Timer Input
Select the source to be played by turning **INPUT**.
 - Timer recording is possible only when you select TUNER or AUX.

3. Timer REC
Select the recording component by turning **INPUT**. If you wish to enjoy timer playback with the TUNER or AUX settings, select “REC Mode OFF”.

(Example)



4. ON Time
“ON Time” appears on the display for a second, and changed to the time setting mode.
Press **HOUR** to set the hour.
Press **MIN** to set the minute.
5. OFF Time
Set the time the same way as above.
If you set the ON time but not OFF time, timer play or recording will finish automatically after an hour.

Notes

- The display mode changes after approximately 8 seconds. If you change the mode before completing setting, press **DISPLAY** once or more to return to the desired mode.
- If you select the input other than TUNER and AUX on “2. Timer Input”, “3. Timer REC” is skipped.

2 Press **TIMER** to complete the timer setting.
The system changes to the standby mode.

- **TIMER** indicator lights up.

If you continue using the system, press **STANDBY/ON** to turn on this unit.

To cancel the timer play setting

Press **DISPLAY** to show the current time, then press **TIMER** so that “TIMER” disappears from the display. You can also cancel the timer play setting by pressing **TIMER** when the unit is in standby mode.

Note

- In the event of a power failure or when the AC power cord is disconnected for more than five minutes, you must reset the clock.

Sleep timer

The unit can be set to automatically place itself in standby mode after a designated time.

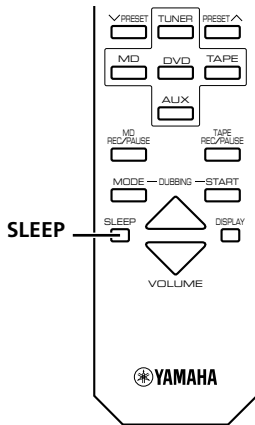

- 1** Play the desired sound source.
- 2** Press **SLEEP** repeatedly until the desired sleep time appears in the display. Each time you press **SLEEP**, the sleep time changes as follows:

SLEEP 2h00m



SLEEP 1h30m



SLEEP 1h00m



SLEEP 0h30m



SLEEP OFF

About 4 seconds after setting, the normal display will resume.

- “SLEEP” will appear in the display.

- 3** The unit will turn off automatically when the selected sleep time is reached.

Controlling other components

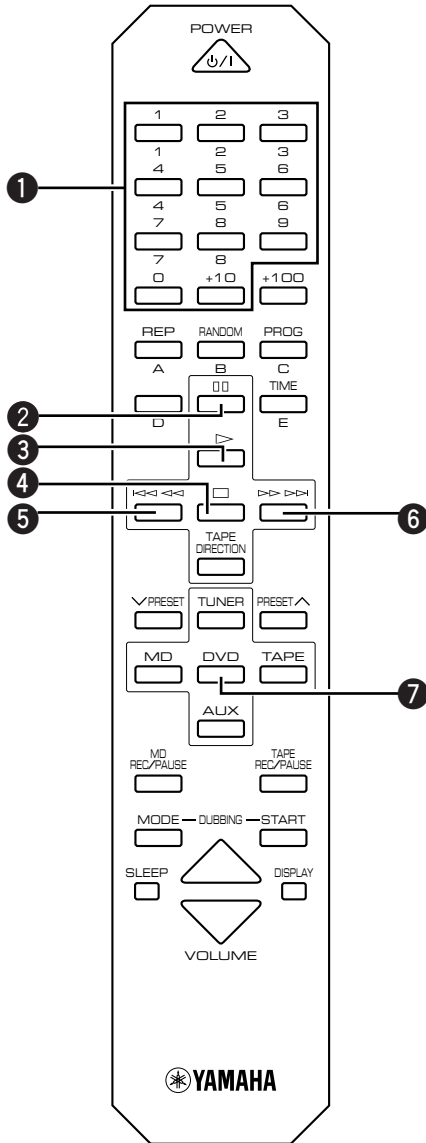

DVD-E600

- 1** Numeric buttons
 - +100 button is used when operating MDX-E300.
- 2** (Pause)
- 3** (Play)
- 4** (Stop)
- 5** (Skip/Search Backward)
- 6** (Skip/Search Forward)
- 7** **DVD** input

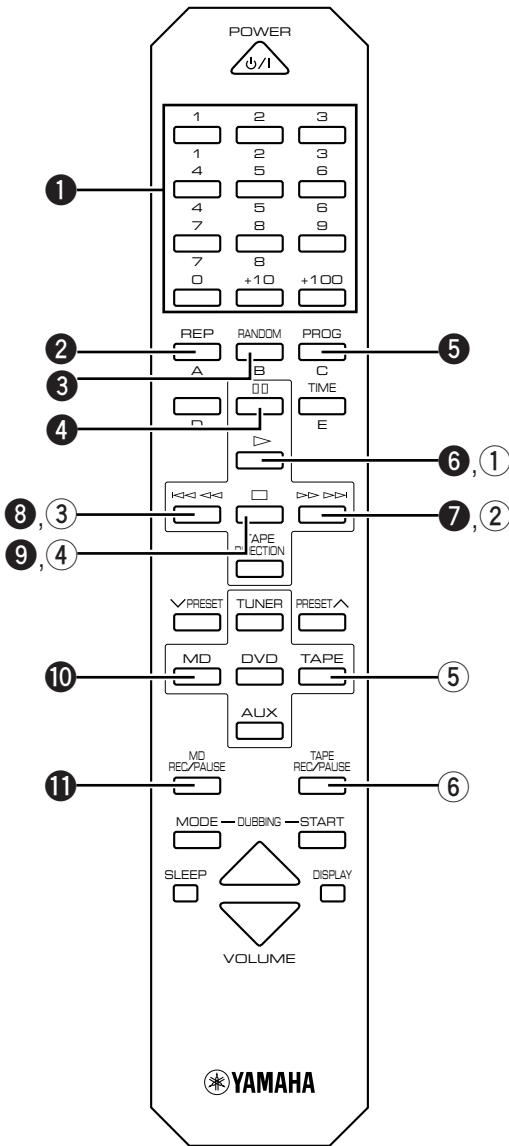

MDX-E300

- ① Numeric buttons
- ② REP (Repeat)
- ③ RANDOM
- ④ (Pause)
- ⑤ PROG (Program)
- ⑥ (Play)
- ⑦ (Skip/Search Forward)
- ⑧ (Skip/Search Backward)
- ⑨ (Stop)
- ⑩ MD input
- ⑪ MD REC/PAUSE

KX-E300

- ① (Play)
- ② (Fast-forward)
- ③ (Rewind)
- ④ (Stop)
- ⑤ TAPE input
- ⑥ TAPE REC/PAUSE

Before recording

Follow the instructions as described in “Connecting the system” on page 5 before using the MDX-E300 or KX-E300 to record. For details, refer to the instructions supplied with the MDX-E300 or KX-E300. Sources connected to the **AUX** terminal can be recorded to tape or MD.

Dubbing setting

There are six combinations of components. When you select a mode, recording for mode starts and ends automatically in a manner preset for that mode.

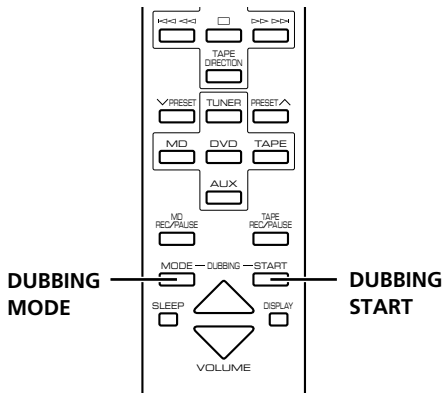

1 Select a component combination. Each time you press **DUBBING MODE**, the mode changes in the following order:

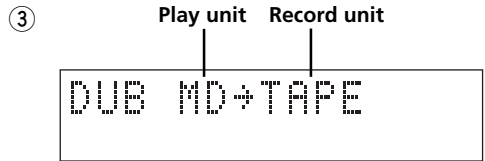
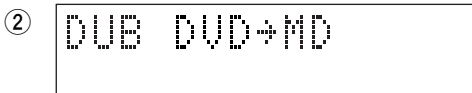
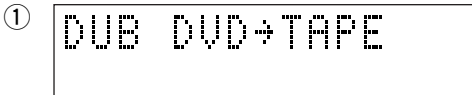

- Recording automatically starts at the beginning of the tape. (Pressing **DUBBING START** automatically rewinds the tape to the beginning)

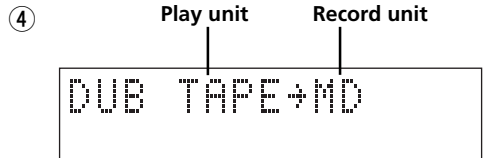

- Recording automatically starts at the beginning of the tape. (Pressing **DUBBING START** automatically rewinds the tape to the beginning)

2 Press **DUBBING START** to start recording.

Note

- The displays ①~④ which include the component you have not connected to your receiver (RX-E600) will be skipped.

To stop dubbing

Press **□**.

Note

- If DVD playback stops or completes when you are using the DVD player as a recording source, the recording component records 10 additional seconds of silence.

Troubleshooting

If the unit fails to operate normally, check the following points to determine whether the fault can be corrected by the simple measures suggested. If it cannot be corrected, or if the fault is not listed in the SYMPTOM column, disconnect the power cord and contact your authorized YAMAHA dealer or service center for help. When receiving service, other Piano Craft components you are using together with this unit may be needed.

| SYMPTOM | CAUSE | REMEDY |
|--|--|---|
| The unit does not switch ON when the STANDBY/ON switch is pressed. | The AC power cord is not connected or not completely connected. | Securely connect the power cord. |
| No sound from one speaker. | Loose speaker connections. | Connect properly. |
| The sound suddenly goes off. | The protection circuit has been activated because of a short circuit, etc. | Check the speaker wires are not touching each other and then turn the unit back on. |
| No sound from an external unit connected with this unit or play does not begin. | Incorrect cord connections. | Connect the cords properly. If the problem persists, the cords may be defective. |
| | Input source selection is not proper. | Make a proper input source selection. |
| Sound distorted. | The component connected to this unit is disconnected from AC outlet. | Connect the AC power cord of the component to an AC outlet. |
| Excessive static in FM broadcasts. | Interference from starting motor of a nearby car. | Position the FM antenna as high and as far away from nearby roads as possible. Connect using a coaxial cable. |
| | Interference from the thermostat of a nearby electrical appliance. | |
| Noise increases during stereo broadcasts. | Antenna input is too weak due to obstructions or excessive distance from the broadcasting station. | Check the antenna connection. |
| | | Install a multi-element type FM antenna if possible. |
| Stereo broadcasts are noisy and STEREO indicator blinks on and off. | Insufficient antenna input. | Install an antenna appropriate for the electric field strength of your area. |
| Cannot select preset stations. | Preset memory has been erased. | Reprogram memory presets. |
| Buzzing or static during AM broadcasts. | Interference from sources such as lightning, fluorescent lights, electric motors or thermostat of nearby electrical appliance. | The problem is difficult to eliminate, but can be lessened by grounding AM loop antenna. |
| | TV or microprocessor is being used nearby. | Move away from TV or microprocessor. |
| AM broadcast sensitivity is poor. | Radio signal is weak or the antenna is not properly connected. | Properly connect the AM loop antenna. |
| | | Change orientation of the AM loop antenna. |
| | | Install an external AM loop antenna. |
| Cannot set timer. | Current time is not set. | Set current time. |
| The unit does not work normally. | The internal microcomputer has been frozen by an external electric shock (lightning, excessive static electricity, etc.) or the power supply with low voltage. | Unplug the AC power cord from the wall outlet, and then plug in again after about one minute. |

ADDITIONAL INFORMATION

| SYMPTOM | CAUSE | REMEDY |
|--|--|--|
| The remote control does not work. | The batteries of the remote control are too weak. | Replace the batteries with new ones. |
| | Remote control is too far away or is being used at an incorrect angle. | Use within 6 meters and 60 degree radius. |
| | Direct sunlight or lighting (of an inverter type of fluorescent lamp, etc.) is striking the remote control sensor of the unit. | Change the position of the unit. |
| TV functions strangely when the remote control is being used. | Remote control is being used near TV set with a remote control sensor. | Relocate this unit away from the TV or cover the TV's remote control sensor. |

Specifications

Amplifier section

| | |
|--|--------------------------|
| Minimum RMS output power per channel | |
| 55 W + 55 W (6Ω 1kHz 0.1% THD) | |
| 40 W + 40 W (6Ω 20 Hz to 20 kHz 0.1% THD) | |
| DIN Standard output power per channel (Europe model) | |
| 60 W + 60 W (4Ω 1kHz 0.7% THD) | |
| Input sensitivity/Impedance | |
| DVD/TAPE/MD/AUX | 150 mV/47 kΩ |
| Frequency response | |
| DVD etc. | 20 Hz to 20 kHz, ±0.5 dB |
| Total Harmonic Distortion (20 Hz to 20 kHz) | |
| DVD etc. 20 W, 6 Ω | 0.04% |
| Signal-to-Noise ratio (IHF-A Network) | |
| DVD etc. (250 mV, Input shorted) | 98 dB |
| Output level/Impedance | |
| PHONES | 0.43 V/330 Ω |

Tuner section

| | |
|--|-------------------------------|
| Tuning range | |
| FM | |
| [U.S.A. and Canada models] | 87.5 – 107.9 MHz |
| [U.K., Europe, Australia and Korea models] | |
| | 87.50 – 108.00 MHz |
| [Asia and General models] | 87.5/87.50 – 108.0/108.00 MHz |
| AM | |
| [U.S.A. and Canada models] | 530 – 1710 kHz |
| [U.K., Europe, Australia and Korea models] | 531 – 1611 kHz |
| [Asia and General models] | 530/531 – 1710/1611 kHz |
| Sensitivity | |
| FM (S/N 30dB) | 1.0 μV |
| AM | 300 μV/m |

General

| | |
|----------------------------------|--|
| Power supply | |
| [U.S.A. and Canada models] | AC 120 V, 60 Hz |
| [Australia model] | AC 240 V, 50 Hz |
| [U.K. and Europe models] | AC 230 V, 50 Hz |
| [Asia and General models] | |
| | AC 110/120/220/230-240 V, 50/60 Hz |
| [Korea model] | AC 220 V, 60 Hz |
| Power consumption | |
| [U.S.A. and Canada models] | 110 W |
| [Other models] | 125 W |
| Power consumption (standby mode) | |
| [U.S.A. and Canada models] | 0.7 W |
| [Other models] | 0.8 W |
| Dimensions (W x H x D) | |
| | 217 x 108 x 372 (8-5/8" x 4-1/4" x 14-8/5") mm |
| Weight | 5.4 (11.9 lbs) kg |

Specifications are subject to change without notice.