

YAMAHA A-1020

*Natural Sound Stereo Integrated Amplifier
Auto Class A Power Output
Zero Distortion Rule Amplification in Power and EQ Stages
Extended Rolloff Equalizer and Pure Current Dam
Direct MC Cartridge Connection and Selectable Cartridge Impedance
Tone Bypass Switch, Rec Out, Continuously Variable Loudness Control
Three-Pair Speaker Support*

Thank you for purchasing the YAMAHA A-1020 stereo integrated amplifier.

CONTENTS

SAFETY INSTRUCTIONS	1/2
CAUTION	2
CONNECTION DIAGRAM	3
CONNECTIONS	4/5
FRONT PANEL PARTS AND FUNCTIONS	6/7/8
BLOCK DIAGRAM	9
TROUBLESHOOTING	10
SPECIFICATIONS	11

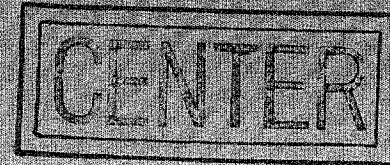

OWNER'S MANUAL

IMPORTANT

Please record the serial number of your unit in the space below.

Model: **A-1020**

Serial No.:

The serial number is located on the rear of the chassis.

Retain this Owner's Manual in a safe place for future reference.

WARNING

To prevent fire or shock hazard, do not expose this appliance to rain or moisture.

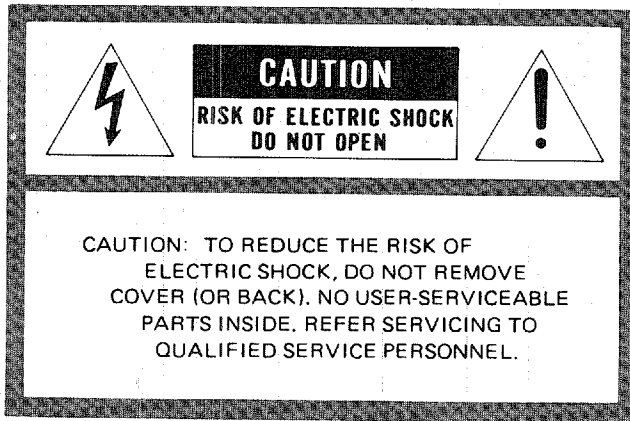

• Explanation of Graphical Symbols

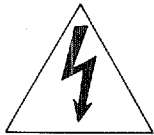

The lightning flash with arrowhead symbol, within an equilateral triangle, is intended to alert you to the presence of uninsulated "dangerous voltage" within the product's enclosure that may be of sufficient magnitude to constitute a risk of electric shock to persons.

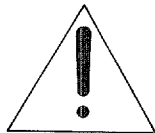

The exclamation point within an equilateral triangle is intended to alert you to the presence of important operating and maintenance (servicing) instructions in the literature accompanying the appliance.

SAFETY INSTRUCTIONS

- 1 **Read Instructions** — All the safety and operating instructions should be read before the appliance is operated.
- 2 **Retain Instructions** — The safety and operating instructions should be retained for future reference.
- 3 **Heed Warnings** — All warnings on the appliance and in the operating instructions should be adhered to.
- 4 **Follow Instructions** — All operating and other instructions should be followed.
- 5 **Water and Moisture** — The appliance should not be used near water — for example, near a bathtub, washbowl, kitchen sink, laundry tub, in a wet basement, or near a swimming pool, etc.
- 6 **Carts and Stands** — The appliance should be used only with a cart or stand that is recommended by the manufacturer.
- 7 **Wall or Ceiling Mounting** — The appliance should be mounted to a wall or ceiling only as recommended by the manufacturer.
- 8 **Ventilation** — The appliance should be situated so that its location or position does not interfere with its proper ventilation. For example, the appliance should not be situated on a bed, sofa, rug, or similar surface that may block the ventilation openings; or placed in a built-in installation, such as a bookcase or cabinet that may impede the flow of air through the ventilation openings.
- 9 **Heat** — The appliance should be situated away from heat sources such as radiators, stoves, or other appliances that produce heat.
- 10 **Power Sources** — The appliance should be connected to a power supply only of the type described in the operating instructions or as marked on the appliance.
- 11 **Power-Cord Protection** — Power-supply cords should be routed so that they are not likely to be walked on or pinched by items placed upon or against them, paying particular attention to cords at plugs, convenience receptacles, and the point where they exit from the appliance.
- 12 **Cleaning** — The appliance should be cleaned only as recommended by the manufacturer.
- 13 **Nonuse Periods** — The power cord of the appliance should be unplugged from the outlet when left unused for a long period of time.
- 14 **Object and Liquid Entry** — Care should be taken so that objects do not fall into and liquids not spilled into the inside of the appliance.
- 15 **Damage Requiring Service** — The appliance should be serviced by qualified service personnel when:
 - A. The power-supply cord or the plug has been damaged; or
 - B. Objects have fallen, or liquid has been spilled into the appliance; or
 - C. The appliance has been exposed to rain; or
 - D. The appliance does not appear to operate normally or exhibits a marked change in performance; or
 - E. The appliance has been dropped, or the cabinet damaged.
- 16 **Servicing** — The user should not attempt to service the appliance beyond those means described in the operating instructions. All other servicing should be referred to qualified service personnel.

**CAUTION: READ THIS BEFORE
OPERATING YOUR A-720**

- 1**
The A-720 is a sophisticated integrated stereo amplifier. To ensure proper operating for the best possible operation, please read this manual carefully.
- 2**
Choose the installation of your A-720 carefully. Avoid placing it in direct sunlight or close to a source of heat. Also avoid locations subject to vibration and excessive dust, heat, cold or moisture. Keep away from such sources of hum as transformers or motors.
- 3**
Do not open the cabinet as this might result in damage to the set or electrical shock. If a foreign object should get into the set, contact your dealer.
- 4**
Do not place records or other objects on top of the amplifier so that the ventilation holes are blocked. This will cause the internal temperature to rise and may result in a failure.
- 5**
When removing the power plug from the wall outlet, always pull directly on the plug; never yank the cord.
- 6**
Do not use force when using the switches and knobs.
- 7**
When moving the set be sure to first pull out the power plug and remove cords connecting to other equipment.
- 8**
Always set the volume controls to "∞" while lowering the tonearm to play a record, then turn the volume up after the stylus is seated in the record groove.
- 9**
Do not attempt to clean the A-720 with chemical solvents as this might damage the finish. Use a clean, dry cloth.
- 10**
Be sure to read the "troubleshooting" section for advice on common operating errors before concluding that your A-720 is faulty.
- 11**
Keep this manual in a safe place for future reference.
- 12**
Do not connect audio equipment to the AC outlets on the rear panel if that equipment requires more power than the outlets are rated to provide.

A-1020

CONNECTION DIAGRAM

* Before making any connections, turn off all equipment. Be sure to connect the left (L) and right (R) channels consistently from component to component.

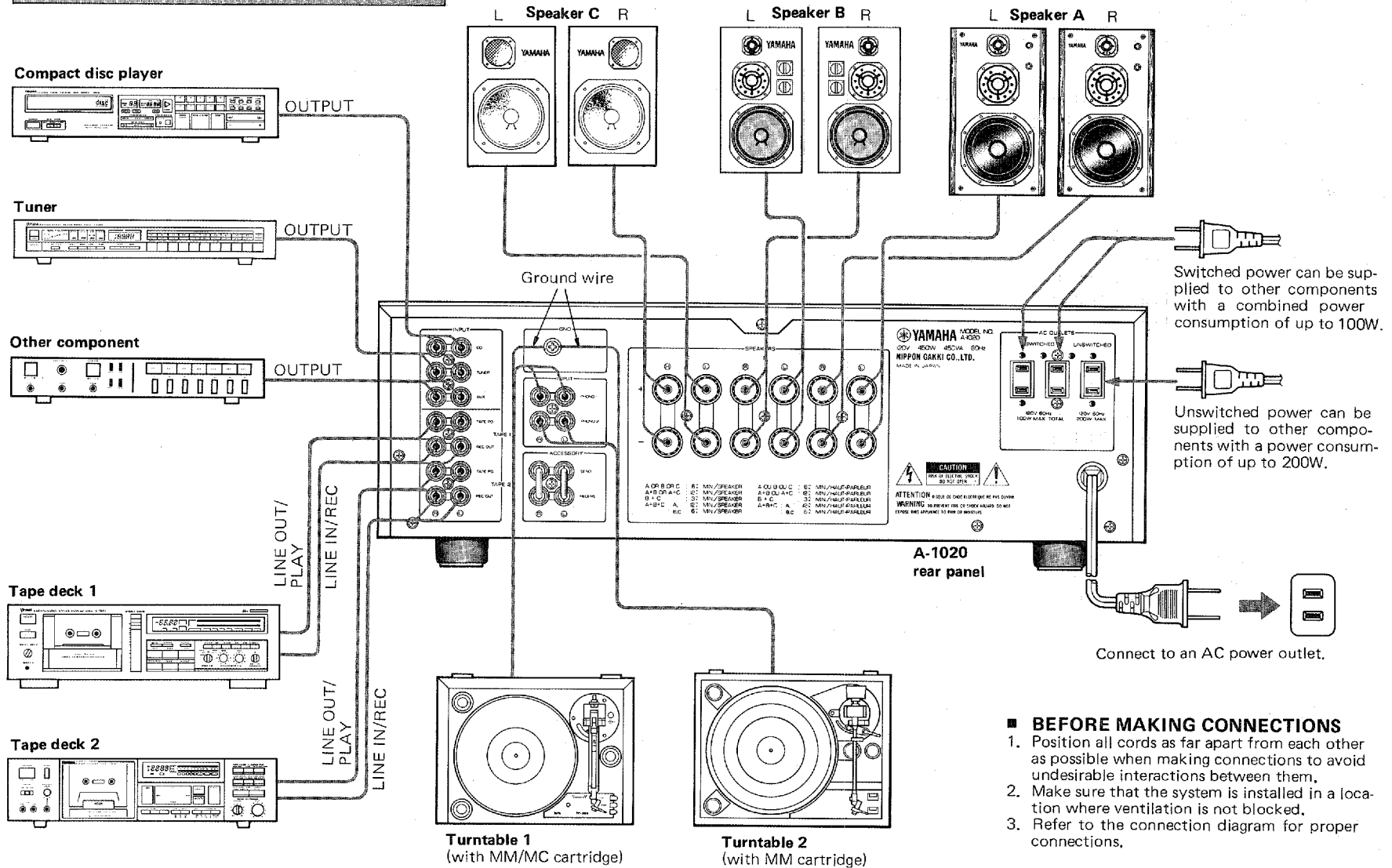

CONNECTIONS

● CONNECTING THE SPEAKERS

The matching impedance of this amplifier is 6Ω.

Speakers connected to A will be in parallel with speakers connected to B and/or C. Speakers connected to B and C will be in series with each other.

A maximum of three sets of speakers can be connected to the A-1020. You have a choice of four options:

- (1) to connect one pair of speakers to terminals A, B, or C.
- (2) to connect two pairs of speakers in parallel (one pair at A and another at either B or C).
- (3) to connect two pairs of speakers in series (one pair at B and another at C).
- (4) to connect three pairs of speakers at A, B and C.

In making any chosen hookup, observe the speaker load impedances:

- (1) One speaker pair—
A or B or C: 4 ohms minimum per speaker
- (2) Two speaker pairs in parallel—
A + B or A + C: 8 ohms minimum per speaker
- (3) Two speaker pairs in series—
B + C: 2 ohms minimum per speaker
- (4) Three speaker pairs—
A + B + C: 8 ohms minimum for A
4 ohms minimum for B and C

Use of any speaker with lower impedance than the above is not recommended.

* When using either the B or C Speaker terminals independently of the other, it is necessary that the terminals not being used are turned OFF with the front panel speaker selector switch. If they are left ON, no sound will be heard.

Connect the cords going to the left speakers to the L terminals and the right speaker cords to the R terminals, making sure that the "+" and "-" marking are observed. If the "+" and "-" wires are reversed at either speaker, the sound will be unnatural and will lack bass. Speaker cords should be cut as short as possible; do not coil up excess wire on the floor. Also, do not bundle with cords from other system components.

Strip about 1cm insulation from the ends of the speaker cords. Loosen the speaker terminal knobs, insert the exposed wire of the speaker cord into the hole and then tighten up the speaker terminal knobs.

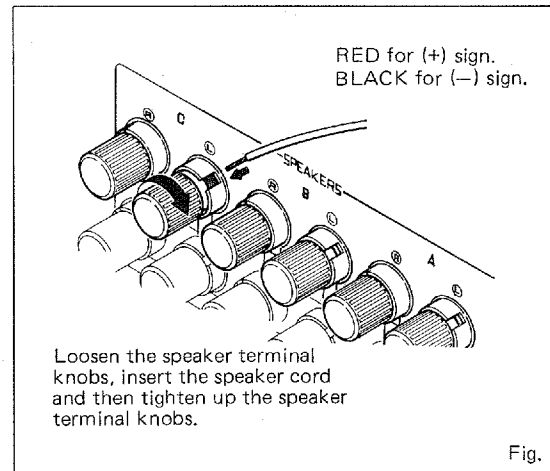

● CONNECTING THE TURNTABLE

Either an MM cartridge or an MC cartridge may be used with the Phono 1 jacks. Set the front panel Phono Selector switch to correspond to the type of cartridge used.

Only an MM cartridge should be used with the Phono 2 jacks. The cartridge load impedance may be selected for MM cartridges.

Plug your turntable into the appropriate jacks and connect the turntable's ground wire to the Gnd terminal. Normally, connecting the ground wire results in minimum hum, but in some cases better results are obtained with the ground wire disconnected. The cartridge and the turntable's output cords should be positioned well away from sources of hum as power cords or power transformers of other system components.

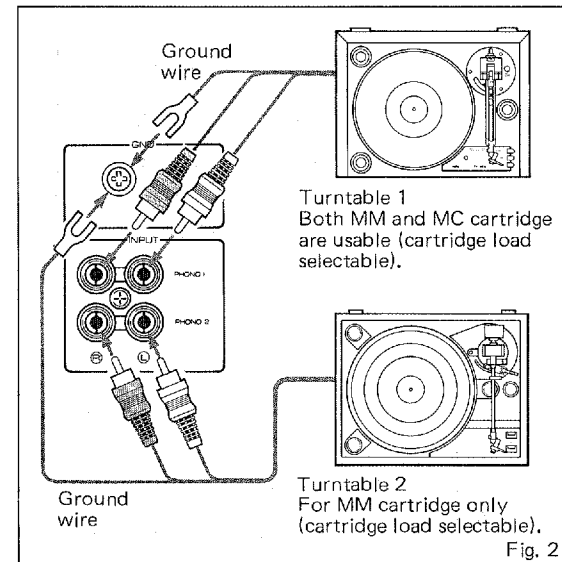

● CONNECTING A TUNER

Connect cords from the tuner's output jacks to the Tuner jacks of the amplifier. As the amplifier's power supply may generate a certain amount of radio frequency noise, position the tuner so that its AM antenna is well away from the amplifier.

A-1020

● CONNECTING TO THE CD AND AUX JACKS

The CD and AUX terminals can be used for connecting additional equipment such as a compact disc player, a second tuner, etc. Note that a turntable cannot be connected to the CD jacks as there is no RIAA equalization.

● CONNECTING A TAPE DECK

Connect the tape deck's Line in jacks to the amplifier's Tape 1 Rec Out jacks, verifying that left and right are not reversed. Then, connect the deck's Line Out jacks to the amplifier's Tape 1 Tape PB jacks. A second deck may be connected to the Tape 2 jacks if desired.

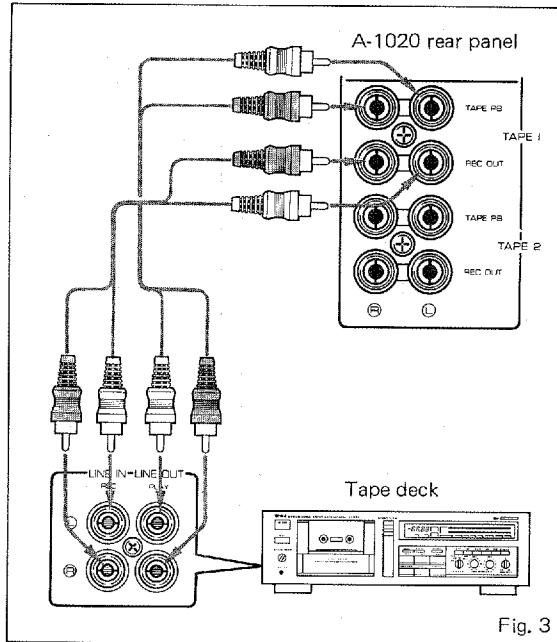

● AC OUTLETS

For your convenience, the A-1020 provides 3 AC outlets (2 switched and 1 unswitched) on the rear panel. Be sure not to connect appliances to totaling more than 200 watts to the 2 switched outlets or more than 200 watts to the unswitched outlet.

● ACCESSORY JACKS

For extra system flexibility, this amplifier allows you to connect a signal processing system such as an equalizer in the signal path prior to the tone control. Connect the Accessory Send terminals to the inputs of the equalizer and the outputs of the equalizer to the Accessory Receive terminals.

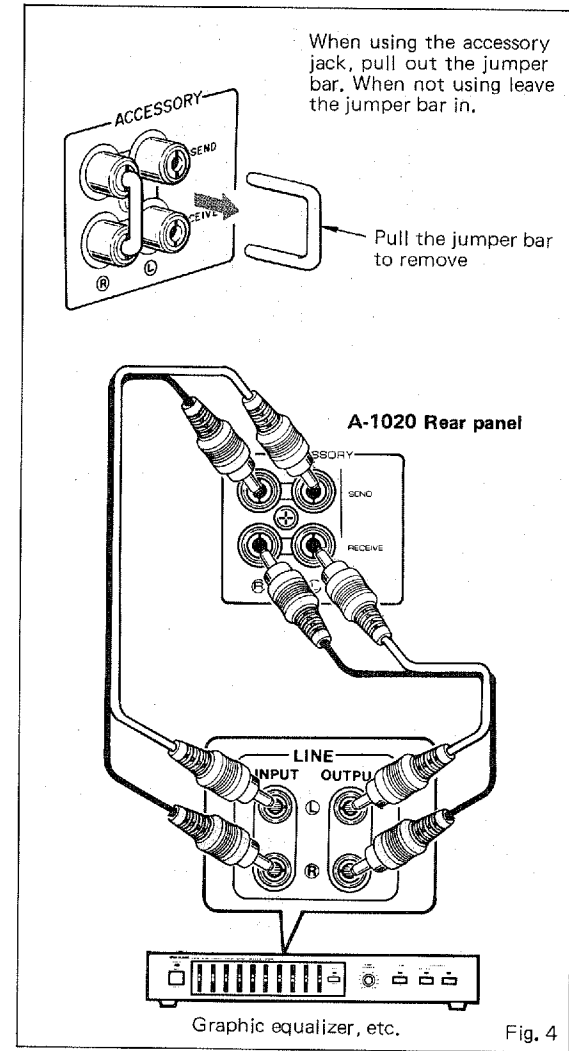

FRONT PANEL PARTS AND FUNCTIONS

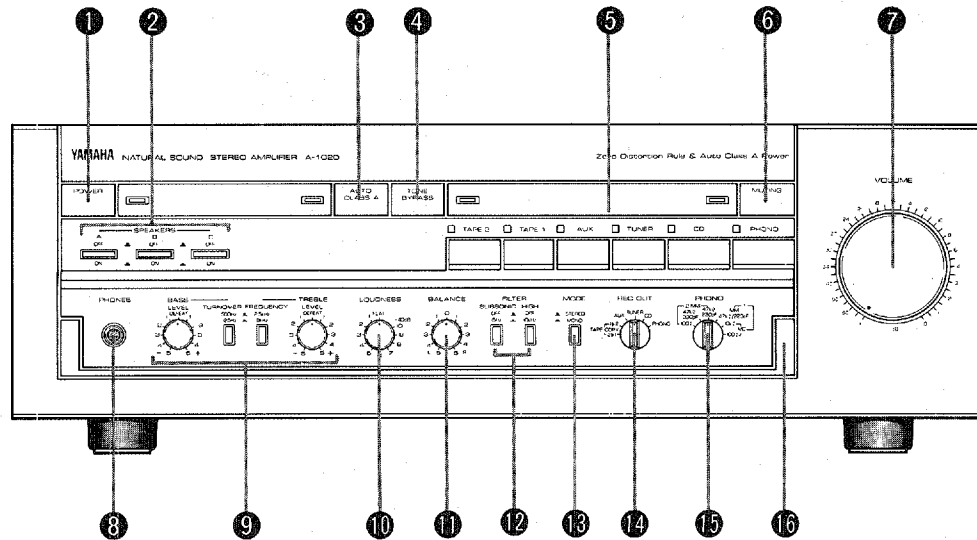

1 POWER SWITCH

This is a "push-on, push-off" type POWER switch. When POWER is pushed on, the indicator lamp corresponding to the selected input source will light.

- * Before pushing power on, set the volume to its lowest (extreme counter-clockwise) position to prevent any loud power-on noise from occurring.
- * No sound will be heard from the speakers for several seconds after power is pushed on because the speaker protection circuit is activated.

2 SPEAKER SELECTION SWITCHES

The chart shows the effects of the A, B, and C speaker switches on all the possible speaker configurations of the A-1020.

When listening to headphones only, turn both A, B and C off.

- * When using either the B or C Speaker terminals independently of the other, it is necessary that the terminals not being used are turned OFF with the front panel speaker selector switch. If they are left ON, no sound will be heard.

SPEAKER SWITCH SETTING CHART

	A SWITCH	B SWITCH	C SWITCH
A only	ON	OFF	OFF
B only	OFF	ON	OFF
C only	OFF	OFF	ON
A + B	ON	ON	OFF
A + C	ON	OFF	ON
B + C	OFF	ON	ON
A + B + C	ON	ON	ON

3 AUTO CLASS A (OPERATION SWITCH)

Auto Class A power provides superior distortion-free Class A amplification at low output levels—which account for the majority of all listening situations. When higher output levels are produced, automatically shifts to Class AB amplification for optimum performance at all power levels.

When the switch is in the OFF position, this unit operates as CLASS AB, however, when the switch is in the ON position (left indicator lights up) the operation automatically switches between CLASS A AND CLASS AB.

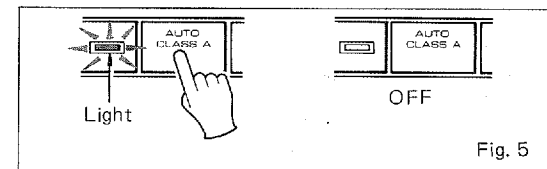

Fig. 5

- * During CLASS A operation there is a greater than normal flow of idling current than for CLASS AB operation even when there are no signals, and because of that together with temperature increases in the set, careful consideration should be given to provide ventilation to release this heat during operation.

4 TONE BYPASS SWITCH

Pressing this switch lights the right indicator and shortens the signal path so that only the DC flat and DC power amplifier (and the phono equalizer on Phono) are in use. This ensures that the effect on your music of the amplifier circuitry and switch contacts will be minimal, but has the drawback that none of the following controls are active:

- Bass and Treble Controls

When none of these controls are being used it is desirable to turn on the Tone Bypass switch from the point of view of music reproduction accuracy, but remember to turn it off again before adjusting these. Note that the Tone Bypass switch can also be used as a convenient way of disabling all the tone controls at once to check their total effect on the sound.

A-1020

5 INPUT SELECTOR SWITCH

Selects the program source to be listened to.

6 MUTING SWITCH

Pressing this switch lights the left indicator and lowers the volume level by 20dB. Pressing the switch again extinguishes the indicator and restores normal volume. This switch is very convenient for lowering the volume temporarily (for instance, to answer a phono call) without disturbing the original volume setting. Also, when listening at low volume levels, turning on Muting makes it easier to control fine gradations of volume.

* Turning the Muting switch off when the volume is turned up could result in a very loud volume that could damage your speakers.

7 VOLUME CONTROL

Used to adjust overall sound volume.

8 PHONES JACK

Used for plugging in headphones. When it is desired to listen to headphones only, Speaker switches A, B and C should all be set to the OFF () position.

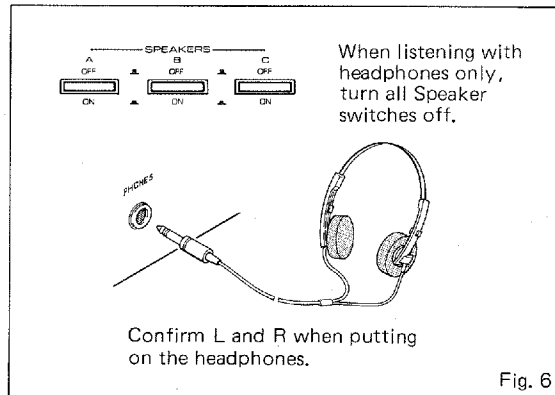

Fig. 6

9 BASS AND TREBLE CONTROLS

The bass control provides turnover frequencies of 125 Hz and 500 Hz. Turning the Bass control with turnover set to 500 Hz will create a bold change in bass response; with the turnover set to 125 Hz the effect will be much less apparent. Flat bass response is produced at the center "DEFEAT" position. The treble control provides turnover frequencies of 2.5 kHz and 8 kHz. Turning the Treble control with turnover set to 2.5 kHz will cause a pronounced change in treble response; with the turnover set to 8 kHz the effect will be more delicate. Flat treble response is produced at the center "DEFEAT" position.

10 LOUDNESS CONTROL

Boosts the extreme low and high frequencies to compensate for our ear's reduced sensitivity to these frequencies at low volume. Set it to the Flat position while the Volume control is set to your normal listening level. Turning it counter-clockwise will reduce the volume while retaining the natural balance of the low and high frequencies.

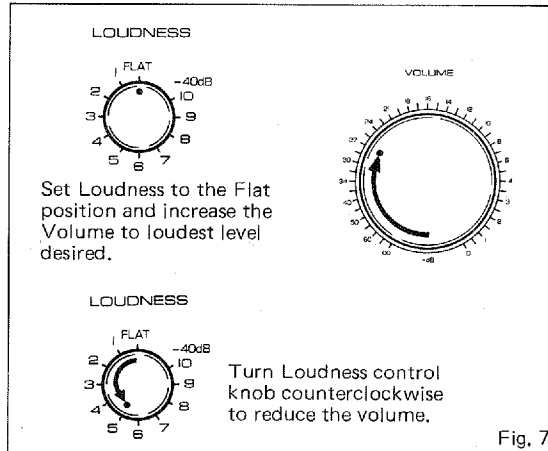

Fig. 7

11 BALANCE CONTROL

This control lets you adjust the relative volume of the left and right speakers, enabling you to compensate for unbalance caused by installation locations of the speakers and furniture arrangement.

12 FILTER SWITCHES

• SUBSONIC FILTER

This switch lets you cut out ultra-low-frequency signals caused by turntable rumble or warped records without affecting the quality of audible sounds. These subsonic interference signals can sap vital power from the amplifier or even harm speakers if not attenuated.

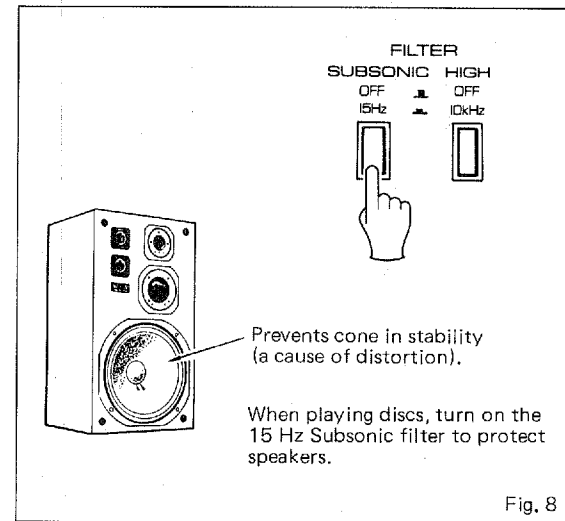

Fig. 8

• HIGH FILTER

Pressing this switch activates the high filter to remove high-frequency noise above 10 kHz such as record surface noise or tape hiss. There is almost no effect on the desired signal, but it is better to keep the switch off when not in use.

13 MODE SWITCH

Allows switching between stereo and mono operation. Normally the switch should be set for stereo.

14 REC OUT SELECTOR

Used for recording, this switch sends the signal from the selected source to the Rec Out jacks (regardless of the position of the Input Selector switch). Set the Input Selector to the same source if you wish to monitor the source as you record, or to any other source to listen to that source while recording. If your tape deck has three-head monitoring capability, you can monitor the signal just recorded on the tape by setting the Input Selector switch to Tape.

• Independent Recording and Listening Examples

Rec Out selector	Input selector	Action
Tuner	Phono	Listening to a record with the speakers while recording an AM or FM broadcast.
Tuner	Tuner	Listen to an FM broadcast with the speakers while recording it.
Phono	Phono	Listen to a record with the speakers while recording it.
Phono	Tuner	Listen to an FM or AM broadcast with the speakers while recording a record.

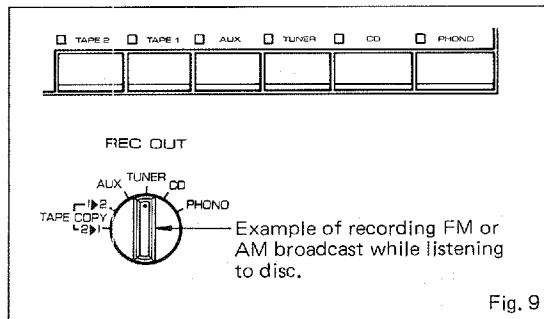

Fig. 9

• Tape Dubbing

Dubbing from the deck connected to the rear panel Tape 1 connectors to the deck connected to the Tape 2 connectors.

1. Set the Rec Out selector to the Tape Copy 1 ► 2 position.

2. Set deck 1 to Play and deck 2 to Record.

To dub from deck 2 to deck 1, set the Rec Out selector to the Tape Copy 2 ► 1 position, set deck 2 to Play and 1 to Record.

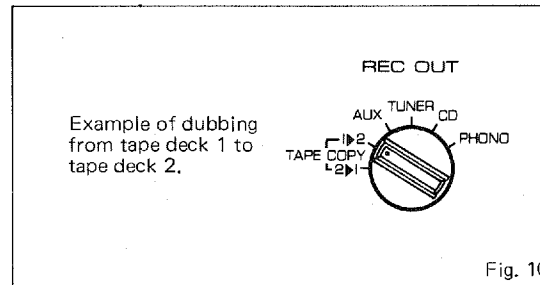

Fig. 10

15 PHONO SELECTOR

Select the appropriate Phono 1 or Phono 2 position, and the appropriate MC or MM cartridge position according to the turntable and cartridge connected to each of the rear panel Phono 1 and 2 input terminals. When selecting Phono 1 also select the proper cartridge load impedance.

1. There are two Phono 1/MC position on the Phono selector for different cartridge load impedances. When using a low output moving coil cartridge, select the load impedance nearest that of the rated impedance of your cartridge.

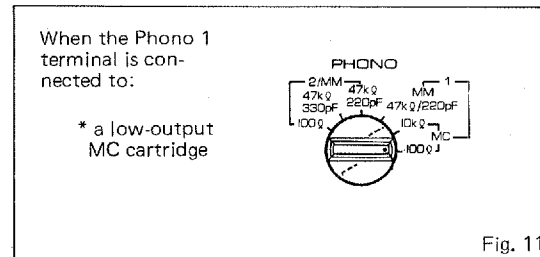

Fig. 11

2. A third position on the Phono 1 input terminal is for exclusive use with MM cartridges, and the load impedance is fixed at 47 k-ohms/220 pF.

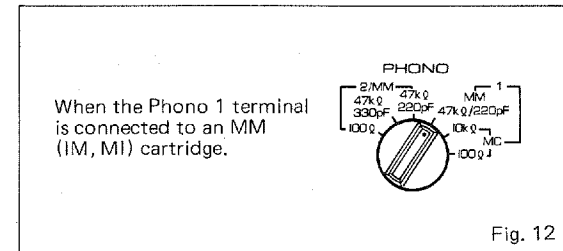

Fig. 12

* Switching the Phono selector to the MC position when an MM cartridge is connected to the Phono 1 input terminals will cause a sudden variation in output volume and will have a harmful effect on your speakers.

* Output voltage may vary with different cartridges according to the manufacturer, so please read the cartridge owner's manual carefully.

3. There are two Phono 2/MM positions for different cartridge load impedances—47 k-ohms (220/330pF) and 100 ohm rated impedance of the cartridge you are using. Switching between the three positions with the same cartridge will vary frequency response. With high output MC cartridges, select the 2/MM "100 ohm" position.

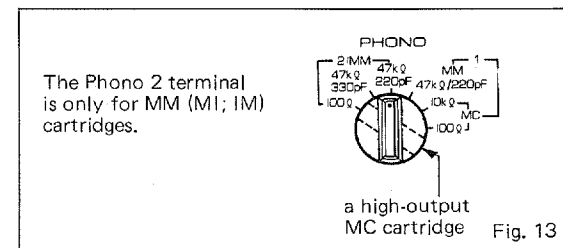

Fig. 13

16 HINGED PANEL

Because the switches and controls which are not frequently operated are centralized, closing the hinged panel allows for an uncluttered panel face. To open, push the panel section lightly.

A-1020

BLOCK DIAGRAM

DC Servo Real Time Equalizer with ZDR.

Auto Class-A Power Amp with ZDR.

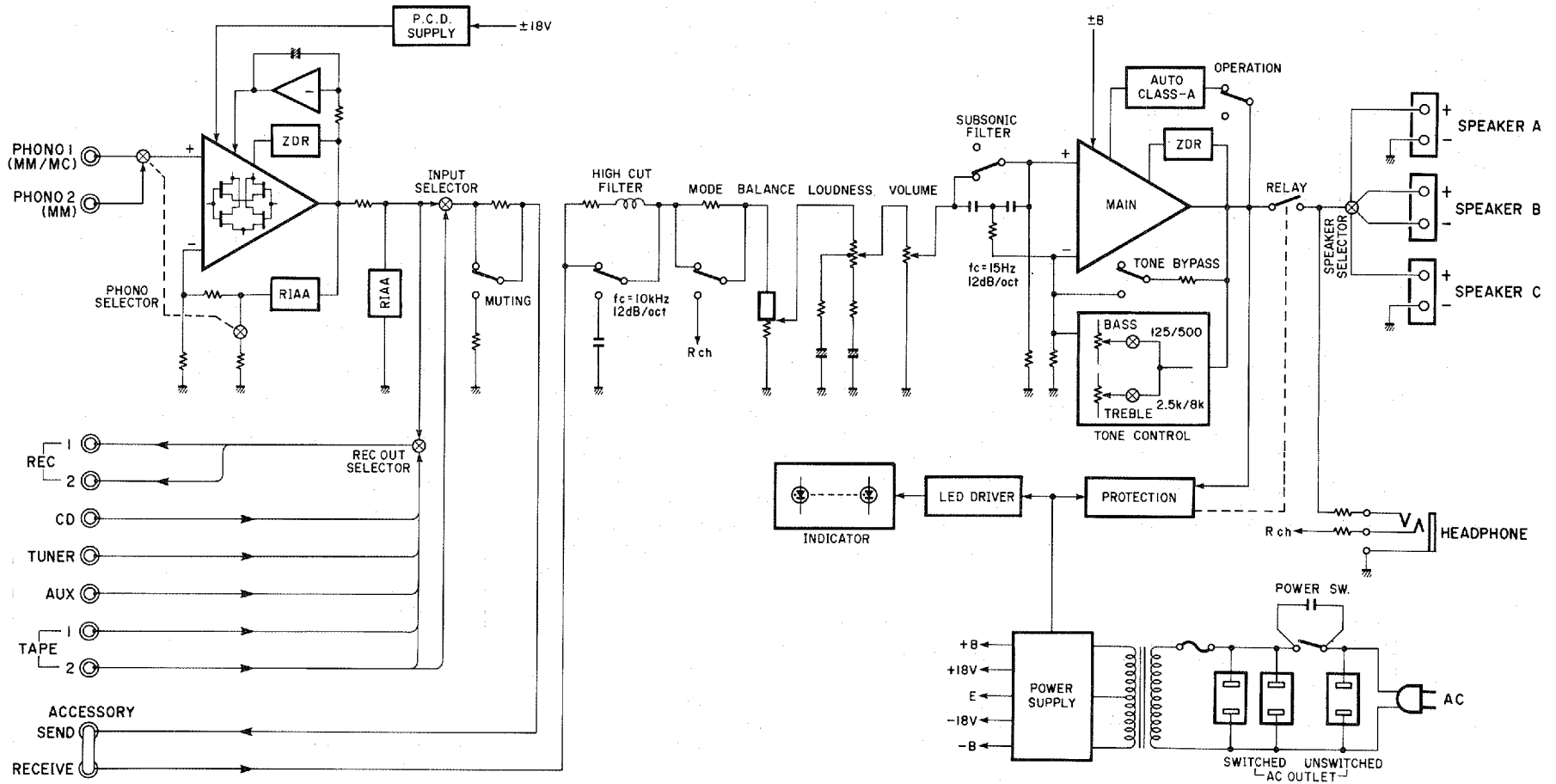

TROUBLESHOOTING

Before assuming that your amplifier is faulty, check the following troubleshooting list which details the corrective action you can take yourself without having to call a service engineer. If you have any doubts or questions, get in touch with your nearest Yamaha dealer.

Fault	Cause	Cure
Power is not supplied even though the Power switch is turned on.	The power plug is not securely plugged in.	Plug it in securely.
	A fuse is blown.	Consult a service engineer.
There is no sound with any Input selector button pressed.	The Speakers switch is not set correctly.	Set the Speakers switch correctly.
	The input cords are not connected securely.	Connect them securely.
	The speaker system is not connected correctly.	Check and secure connections.
There is no sound from one speaker.	The speaker connections are not secure.	Secure the connections.
	The Balance control is set all the way to the left or right.	Adjust the Balance control correctly.
There is a lack of bass and no ambience.	The + and - cords have been reversed at the amp or the speakers.	Connect the speaker wires in the correct phase (+ and -).
There is humming sound when playing records.	The input cords are not connected securely.	Plug the input cords in securely.
	The turntable's ground wire is not connected.	Connect the ground wire.
Sound from MC cartridge is low.	The output of the MC cartridge is connected to the Phono 2 terminal.	Connect it to the Phono 1 terminal.
	The Phono Selector switch is set to MM.	Set the Phono Selector switch to MC.
There is a howling sound when playing records at high volume.	The turntable and the speakers are too close together or the turntable is not mounted on a firm surface.	Change the location of the turntable or the speakers.
Interference from private commercial broadcasting.	A transmitter is located nearby.	Consult a service engineer.
		Consult with the company that is transmitting.
Turning the Bass or Treble knob does not affect the tone.	The Tone Bypass switch is on.	The Tone Bypass switch must be turned off to use the tone controls.
Volume is too low even when the Volume control is turned up.	The Muting switch is on.	Turn the Muting switch off.
The sound suddenly goes off.	Driving speakers outside the rated impedance range at high power for an extended period has activated the speaker protection circuit.	Turning the A-1020 off and then on will reset the speaker protection circuit. Use speakers inside the rated impedance range.
	There is a malfunction in the amplifier.	Consult your Yamaha dealer.

A-1020

SPECIFICATIONS

Continuous Power Per Channel

20Hz ~ 20kHz (0.005% THD 8Ω)	125W
(Class A 5W)	
(0.007% THD 6Ω)	145W
1 kHz (0.005% THD 8Ω)	130W
(0.005% THD 6Ω)	150W

Power Band Width

0.03% THD 62.5W (8Ω)	10Hz ~ 50kHz
----------------------	--------------

Damping Factor

1 kHz 8Ω	45
----------	----

Input Sensitivity/Impedance

Phono 1 MC	160μV/10kΩ, 100Ω
MM	2.5mV/47kΩ 220pF
Phono 2 MM	2.5mV/47kΩ 220pF
	47kΩ 330pF
	100Ω

Input Sensitivity (New IHF)

Phono MC	15μV
MM	0.23mV
Aux, Tape, Tuner, CD	13.4mV

Maximum Input Signal

1 kHz, 0.01% THD Phono MC	10mV
MM	170mV

Output Level/Impedance

Rec Out	150mV/470Ω
---------	------------

Headphone Jack Rated Output/Impedance

0.005% THD	0.91V/8Ω
------------	----------

Frequency Response

CD, Aux, Tape, Tuner	20Hz ~ 20kHz	+0 dB
(Tone Bypass ON)		-0.5dB

RIAA Equalization Deviation

(20Hz ~ 20kHz)	
Phono MC	±0.3dB
MM	±0.2dB

Total Harmonic Distortion

Phono MC to Rec Out (3V)	0.005%
Phono MM to Rec Out (3V)	0.003%
Aux, Tape, Tuner, CD to SP Out 62.5W/8Ω	0.005%

Intermodulation Distortion

Aux, Tape, Tuner, CD Rated Output/8Ω	0.002%
1W/8Ω	0.003%

Signal to Noise Ratio (IHF-A-Net work)

Phono MC (500μV Input Shorted)	80dB
Phono MM (5 mV Input Shorted)	94dB
Aux, Tape, Tuner, CD (Shorted)	106dB

Signal to Noise Ratio (New IHF)

Phono MC	76dB
MM	79dB
Aux, Tape, Tuner, CD	86dB

Residual Noise (IHF-A-Network)

	133μV
--	-------

Channel Separation

Phono MM (Input Shorted 1kHz, vol -30dB)	70dB
Aux, Tape (5.1 kΩ, 1 kHz, vol -30dB)	65dB

Tone Control Characteristics

Bass boost/cut	±10dB (at 20Hz)
turnover frequency	125,500Hz
Treble boost/cut	±10dB (at 20kHz)
turnover frequency	2.5k, 8kHz

Filter Characteristics

Low (Subsonic)	15Hz, -12dB/oct
High	10kHz, -12dB/oct

Continuous Loudness Control (Level-related equalization)

Attenuation	-40 dB (at 1kHz)
-------------	------------------

Audio Muting

	-20dB
--	-------

Gain tracking error (0 to -60 dB)

	2dB
--	-----

Power Supply

	AC120V, 60Hz
--	--------------

Power Consumption

	450W
--	------

AC Outlet

Switched x 2	100W max total
Unswitched x 1	200W max

Dimensions (W x H x D) 435 x 147 x 422 mm
(17-1/8" x 5-3/4" x 16-5/8")

Weight 11.5 kg
(25.3 lbs.)

* Specifications subject to change without notice.

SINCE 1887  **YAMAHA**
NIPPON GAKKI CO., LTD. HAMAMATSU, JAPAN
BWgG.R Printed in Japan