

Auf der Rückseite befindet sich die deutsche Version der Bedienungsanleitung.

PRECAUTIONS

PLEASE READ CAREFULLY BEFORE PROCEEDING

* Please keep this manual in a safe place for future reference.

WARNING

Always follow the basic precautions listed below to avoid the possibility of serious injury or even death from electrical shock, short-circuiting, damages, fire or other hazards. These precautions include, but are not limited to, the following:

Do not open

This device contains no user-serviceable parts. Do not open the device or attempt to disassemble the internal parts or modify them in any way. If it should appear to be malfunctioning, discontinue use immediately and have it inspected by qualified Yamaha service personnel.

Water warning

Do not expose the device to rain, use it near water or in damp or wet conditions. If any liquid such as water seeps into the device, turn off the power of the amplifier immediately and unplug the power cord from the AC outlet. Then have the device inspected or repaired by qualified Yamaha service personnel.

Fire warning

Do not use burning items near the device. It may cause a fire.

If you notice any abnormality

When one of the following problems occur, immediately turn off the power of the amplifier.

- The power cord or plug becomes frayed or damaged.
- It emits unusual smells or smoke.
- Some object has been dropped into the device.
- There is a sudden loss of sound during use of the device.
- There are cracks or damage on the device.

Then have the device inspected by Yamaha service personnel.

CAUTION

Always follow the basic precautions listed below to avoid the possibility of physical injury to you or others, or damage to the device or other property. These precautions include, but are not limited to, the following:

Location

- Do not place the device in an unstable position where it might accidentally fall over and cause injuries.
- Do not place the device in a location where it may come into contact with corrosive gases or salt air. Doing so may result in malfunction.
- Always consult a professional constructor if the device installation requires construction work, and make sure to observe the following precautions.
 - Choose mounting hardware and an installation location that can support the weight of the device.
 - Avoid locations that are exposed to constant vibration.
 - Use the required tools to install the device.
 - Inspect the device periodically.

Connections

- Before connecting the device to a power amplifier, turn off the power for all devices. Before turning the power on or off for all devices, set all volume levels to minimum. It may result in electric shock, hearing loss, or equipment damage.
- Use only speaker cables for connecting speakers to the speaker jacks. Use of other types of cables may result in fire.

Installing the Speakers

Install the speakers onto the ceiling with the supplied hardware. Ensure that the strength of the ceiling rail is sufficiently strong. Illustrations in this manual are for the VXC3F. The installation method is the same for other models.

CAUTION

When attaching the speakers, turn off the power amplifier.

Pre-installation (Preparation of the Cable)

Use stranded wire for cables attached to the Euroblock plug. Strip their insulation as shown in the figure and connect them.

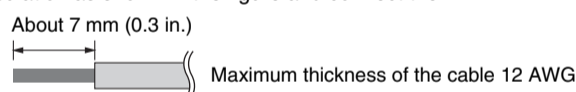

Note
Do not plate stranded wires by solder. Doing so will cause the wire to break.

Make sure that the release lever of the baffle front is in the position as shown in the figure below.

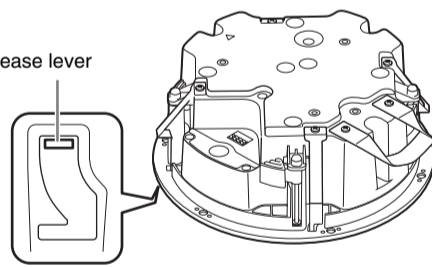

1 Cut Out a Hole in the Ceiling

1 Put the supplied cutout template to the ceiling and draw a circle by tracing it. Make sure to use the cutout template so that hole is the correct diameter.

Note
If you use a circular cutter, set the diameter with the cutout template.

2 Cut the hole by tracing the circle. Be careful to prevent chips or powder entering your eyes while cutting the hole.

2 Install the Tile Rails and O-ring

1 Insert the two tile rails through the cut hole and place them on the ceiling surface within your reach. Be sure that each tile rails are oriented as shown below.

2 Insert the folded O-ring through the cut hole and open it in the ceiling.

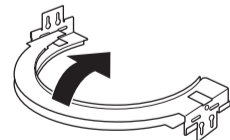

3 Secure the O-ring and tile rails with supplied two screws through either slot of both O-ring brackets.

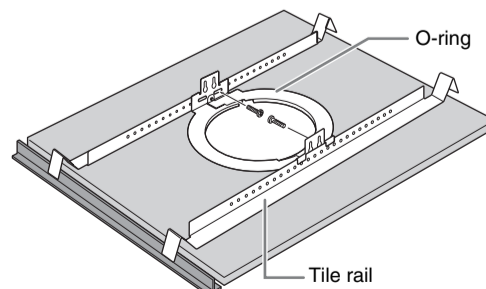

Handling caution

- Do not insert your fingers or hands in the moving part of the release lever/ bass reflex ports.
 - Avoid inserting or dropping foreign objects (paper, plastic, metal, etc.) into any gaps or openings on the device (vents, disc slots, ports, etc.) If this happens, turn off the power of the amplifier immediately and unplug the power cord from the AC outlet. Then have the device inspected by qualified Yamaha service personnel.
 - Do not use the speakers for a long period of time at a high or uncomfortable volume level, since this can cause permanent hearing loss. If you experience any hearing loss or ringing in the ears, consult a physician.
 - Do not operate the device if the sound is distorting. Prolonged use in this condition could cause overheating and result in fire.
 - When choosing a power amplifier for use with this device, make sure that the output power of the amplifier is lower than the power capacity of this device (see General Specifications). If the output power is higher than the power capacity, malfunction or fire may occur.
 - Do not input excessively loud signals that may result in clipping in the amplifier or cause the following:
 - Feedback, when using a microphone
 - Continuous and extremely loud sound from a musical instrument, etc.
 - Continuous and excessive loud distorted sound
 - Noise caused by plugging/unplugging the cable while the amplifier is turned on
- Even if the output power of the amplifier is lower than the power capacity of this device (program), damage to the device, malfunction or fire may occur.

NOTICE

To avoid the possibility of malfunction/damage to the product or damage to other property, follow the notices below.

Handling and maintenance

- When using a high-impedance speaker connection, make sure the audio signal is passed through an 80 Hz or above high-pass filter before being input to the speakers.
- Do not expose the device to excessive dust or vibration, or extreme cold or heat (such as in direct sunlight, near a heater, or in a car during the day), in order to prevent the possibility of panel discoloration, unstable operation, or damage to the internal components.
- Do not place vinyl, plastic or rubber objects on the device, since this might discolor the panel.
- When cleaning the device, use a dry and soft cloth. Do not use paint thinners, solvents, cleaning fluids, or chemical-impregnated wiping cloths.
- Condensation can occur in the device due to rapid, drastic changes in ambient temperature-when the device is moved from one location to another, or air conditioning is turned on or off, for example. Using the device while condensation is present can cause damage. If there is reason to believe that condensation might have occurred, leave the device for several hours without turning on power until the condensation has completely dried out.
- Be sure to observe the amplifier's rated load impedance (see General Specifications), particularly when connecting speakers in parallel. Connecting an impedance load outside the amplifier's rated range can damage the amplifier.
- Protection Circuit
This speaker system has an internal protection circuit that shuts off the speaker unit when an excessive input signal is applied. If the speaker unit emits no sound, reduce the volume level of the amplifier immediately. The sound will return automatically in several seconds.
- Air blowing out of the bass reflex ports is normal, and often occurs when the speaker is handling program material with heavy bass content.
- Do not swing the speaker by its carrying band.
- Do not place the speaker face down with the grille attached, as deformation of the grille may result.
- When placing the speaker face down, always place it on a flat surface.
- Do not touch the speaker driver unit.

About this manual

- The illustrations as shown in this manual are for instructional purposes only.
- The company names and product names in this manual are the trademarks or registered trademarks of their respective companies.

Yamaha cannot be held responsible for damage caused by improper use or modifications to the device.

3 Connect the Wiring to the Connector

- Pull the wiring from the amplifier through the cut hole of the ceiling.
- Pass the cable through the terminal cover.

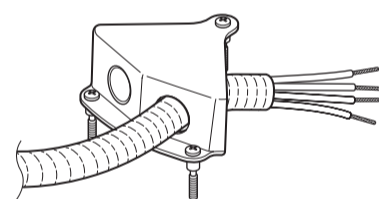

3 After loosening the terminal screws of the Euroblock plug with a flat-blade screwdriver, insert the cable into each terminal and tighten the screws. For the connection, refer to "Connecting the Cable". Make sure that cables cannot be pulled out.

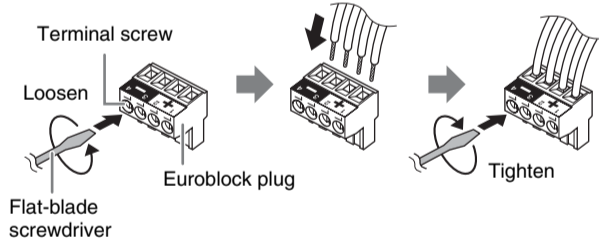

Note
Use a flat-blade screwdriver with a blade less than 3 mm (0.1 in.).

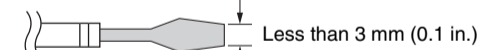

4 Plug the connected Euroblock plug into the socket in the speaker.

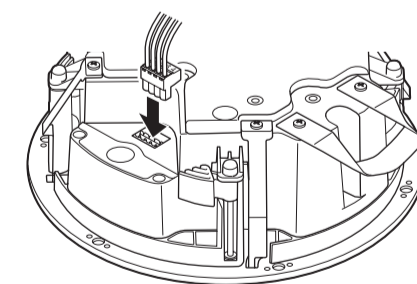

5 Tighten the screw and then attach the terminal cover.

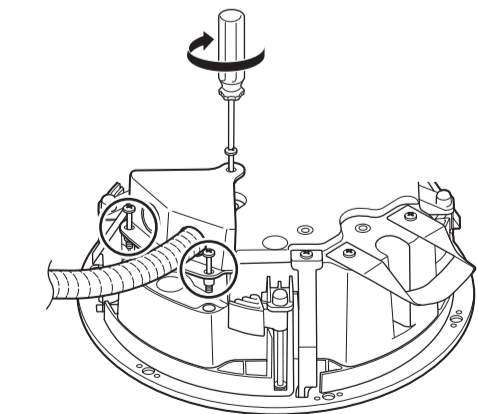

Unpacking

Unpack the contents and confirm that all the following items are included.

- Speaker × 2
- Grille × 2
- Euroblock Plug (4-pin, 5.08 mm pitch) × 2
- Terminal Cover (with 3 screws) × 2
- O-ring × 2
- Tile Rail × 4
- Screw × 4
- Cutout Template × 1
- Owner's Manual (this manual)
- Technical Specifications (English only)

* The speaker cable and safety wire are not included.

General Specifications

	VXC5F/VXC5FW	VXC3F/VXC3FW
Type	Full range, Bass reflex	
Component	4.5" (11.5 cm) Full range unit	3.5" (9 cm) Full range unit
Coverage angle (1 kHz – 4 kHz on average) *1	130° conical	140° conical
Nominal impedance	8 Ω	
Power rating	NOISE	40 W
	PGM	80 W
	MAX	160 W
Sensitivity (1W, 1m) *1	89 dB SPL	87 dB SPL
	111 dB SPL	106 dB SPL
Maximum SPL (Calculated, 1m) *2	60 Hz – 20 kHz	71 Hz – 20 kHz
Frequency range (-10 dB) *1	60 Hz – 20 kHz	
Connector	Euroblock (4 pin) × 1 (input: +/-, loop-thru: +/-) Max. wire size 12 AWG	
Transformer taps	70 V	30 W, 15 W, 7.5 W, 3.8 W
	100 V	15 W, 7.5 W, 3.8 W, 1.9 W
Overload protection	Full-range power limiting to protect network and transducers	
Magnetically shielded	No	
Enclosure	Shape	Round
	Cabinet material	ABS V-0, 3.5 mm, black
	Baffle material	ABS V-0, 5 mm, black
Grille	Material	Powder coated perforated steel (t=0.6 mm) Trim Ring: ABS V-0 Aperture ratio: 46%
	Finish	VXC5F/VXC3F : Black painting (approximate value: Munsell N3)
		VXC5FW/VXC3FW : White painting (approximate value: Munsell 9.3)
Dimensions (Including grille)	Ø324 × 143D mm (Ø12-13/16" × D 5-11/16")	Ø285 × 112D mm (Ø11-1/4" × D 4-7/16")
Net weight (Including grille)	3.1 kg (6.8 lbs)	2.5 kg (5.5 lbs)
Cutout size	Ø285 mm (Ø11-1/4")	Ø247 mm (Ø9-3/4")
Required ceiling board thickness	5 mm – 37 mm	
Conduit tube	Ø15.4 mm – Ø21.3 mm	
Packaging	Packaged in pair	

*1: Half-space (2π)

*2: Calculated based on power rating and sensitivity, exclusive of power compression.

The contents of this manual apply to the latest specifications as of the printing date. Since Yamaha makes continuous improvements to the product, this manual may not apply to the specifications of your particular product. To obtain the latest manual, access the Yamaha website then download the manual file. Since specifications, equipment or separately sold accessories may not be the same in every locale, please check with your Yamaha dealer.

The dimensions are shown in "Technical Specifications".

Connecting the Cable

CAUTION

- When connecting with low impedance, take note of the total impedance.
- When connecting with high impedance, the total input wattages of the connected speakers should lie within the margin of the rated input of the power amplifier. For more information, refer to the description concerning high impedance connection at the following URL.
Yamaha Pro Audio site "Better Sound for Commercial Installations": http://www.yamahaproaudio.com/global/en/training_support/better_sound/

Using Loop-Through Terminals

For this method, cables are connected from terminals 1 and 4 to the subsequent speaker. Cables with a thickness up to AWG 12 can be used. If the Euroblock plug is disconnected from a speaker, all subsequent speakers will not work. This can be useful to identify which speaker has a problem.

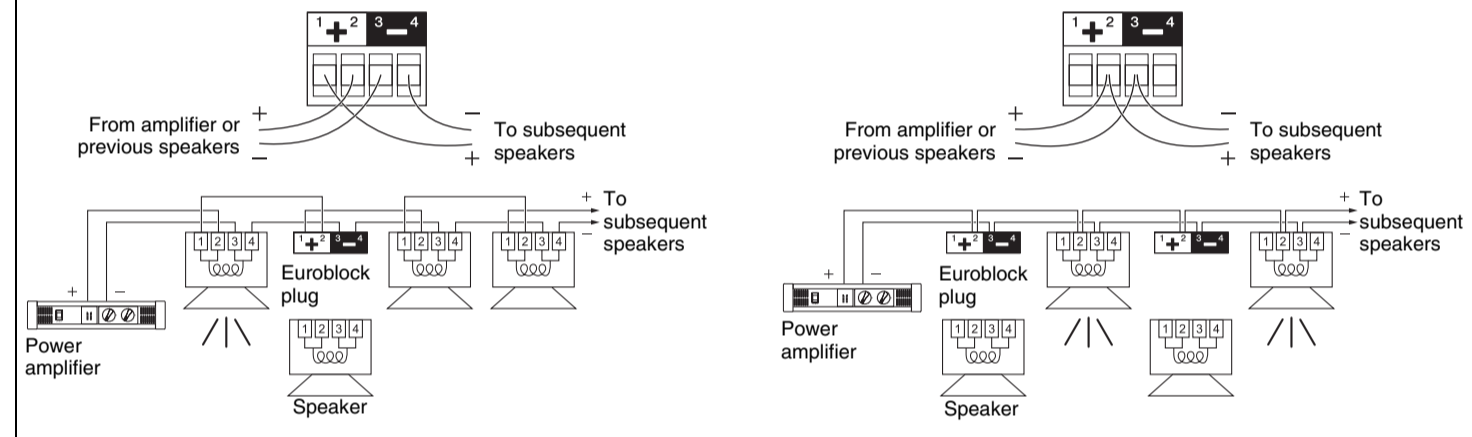

Paralleling Input Terminals

For this method, cables are connected to terminals 2 and 3 of each speaker. Connect two cables to one terminal. Cables with a thickness up to AWG 17 can be used. Since the cables are connected via Euroblock plugs, subsequent speakers can work properly.

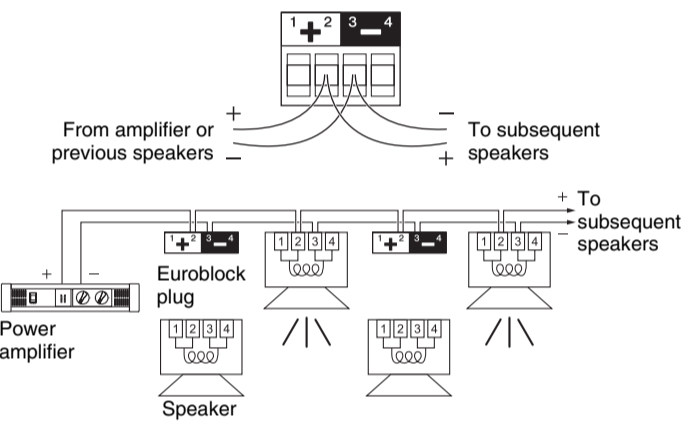

4 Fix the Speakers onto the Ceiling

For safety, use the screw hole on the speaker (M5 × 12 mm) and connect the wire to an independent support point such as a joist.

Example of the connection using an eye bolt

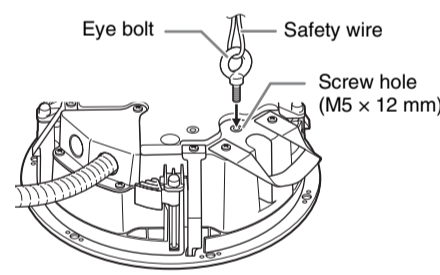

CAUTION

Always take measures to prevent the speaker from falling down. Use a safety wire of appropriate length. Should the speaker fall and the wire is too long, the wire may snap due to excess strain.

1 Take care not to trap the cable, carrying band, or safety wire while slowly pushing the speaker up into the ceiling.

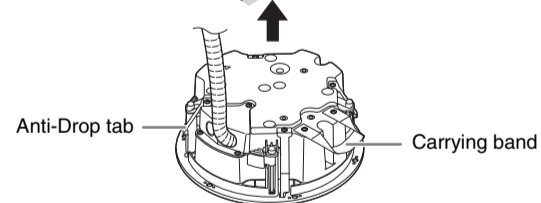
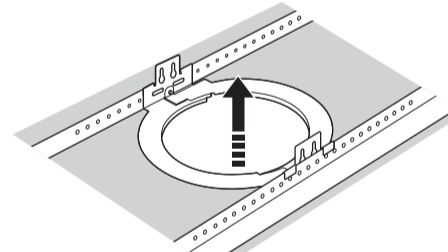

Make sure the release lever is in the position of the figure below. If it is set to the position of the figure, when all the Anti-Drop tabs cross over the O-ring, the speaker is held temporarily.

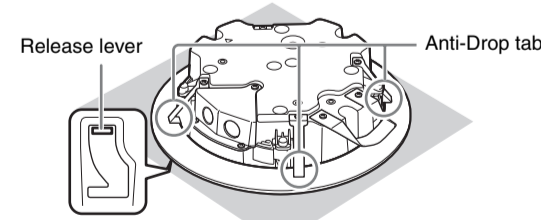

2 While slightly lifting up the speaker, turn the screwdriver clockwise to tighten the attachment screw. The first turn of the attachment screw opens the clamp. Further turns move the clamp down the channel to pull the speaker up into the ceiling.

Note
When the clamp is difficult to open, turning the screwdriver halfway counterclockwise once will make it easier to open the clamp.

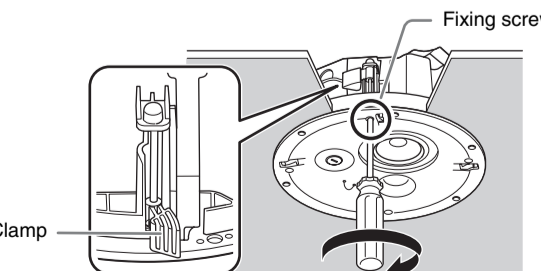

CAUTION

- Do not over-tighten the attachment screw. Otherwise, the attachment screw and clamp will break.
- Do not turn any screws other than attachment screw. Otherwise, the speaker may fall or malfunction.

Removing from the Ceiling

1 Loosen the fixing screw by turning the screw counterclockwise. Loosen the screw and the clamp goes up, and as it reaches the top, the clamp closes as shown in figure below.

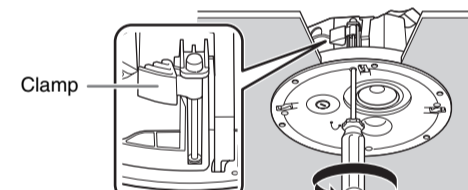

2 While slightly lifting up the speaker, secure it by moving the release lever of the baffle front to the direction of the arrow as shown in the figure.

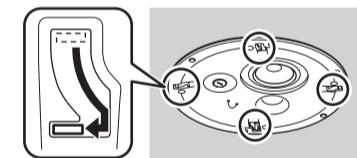

3 Remove the safety wire from the speaker that is detached from the ceiling.

5 Set the Line Voltage/Impedance and Power

Select the line voltage/impedance (100 V/70 V/8Ω) and power tap for 100 V/70 V line distributed system, by rotating the tap selector switch on the front side of the speaker with a flat-blade screwdriver.

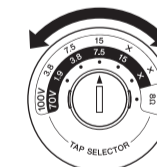

Illustration indicates the setting at 15 W for 100 V line and 7.5 W for 70 V line.

CAUTION

- The "X" position should not be selected. The 8Ω position should be selected for 8Ω audio systems only. If the setting is incorrect, it may cause malfunction of the speaker and amplifier.
- Make sure the amplifier is switched off before operating the tap selector switch.

6 Attach the Grille

Attach the string to the speaker as shown in the figure, then fit the grille to the magnets (6 places) on the baffle front.

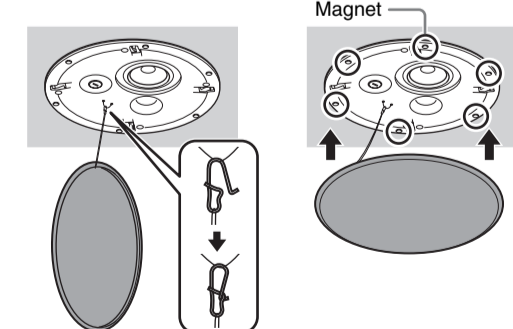

CAUTION

The grille may fall down if it is attached inadequately. Attach it firmly.

