

MIXING CONSOLE

MG06X

MG06 Owner's Manual

Welcome

Thank you for purchasing the Yamaha MG06X/MG06 Mixing Console. Please read this manual thoroughly to get the most out of the product and ensure long-term, trouble-free use. After reading this manual, keep it readily available for future reference. * For the remainder of this manual, the word "mixer" is used instead of "Mixing Console." ** In this manual, all panel illustrations show the MG06X panel.

Main Features

- 6-channel mixer features microphone inputs and stereo/mono line inputs for input jacks.
- Yamaha's premium head amp "D-PRE" for providing high quality sound.
- PAD switch to support a wide variety of inputs to the channels 1/L and 2/R.
- (MG06X) Yamaha's high-quality SPX effects (6 types), providing optimum processing for instruments or vocals.

Included Accessories

- AC power adaptor
- Technical Specifications: Includes block diagram, dimensions, general specifications, and input/output characteristics.
- Owner's Manual (this leaflet)

QuickStart Guide

STEP 1 Connecting speakers, microphones, and instruments, etc.

Connection Example

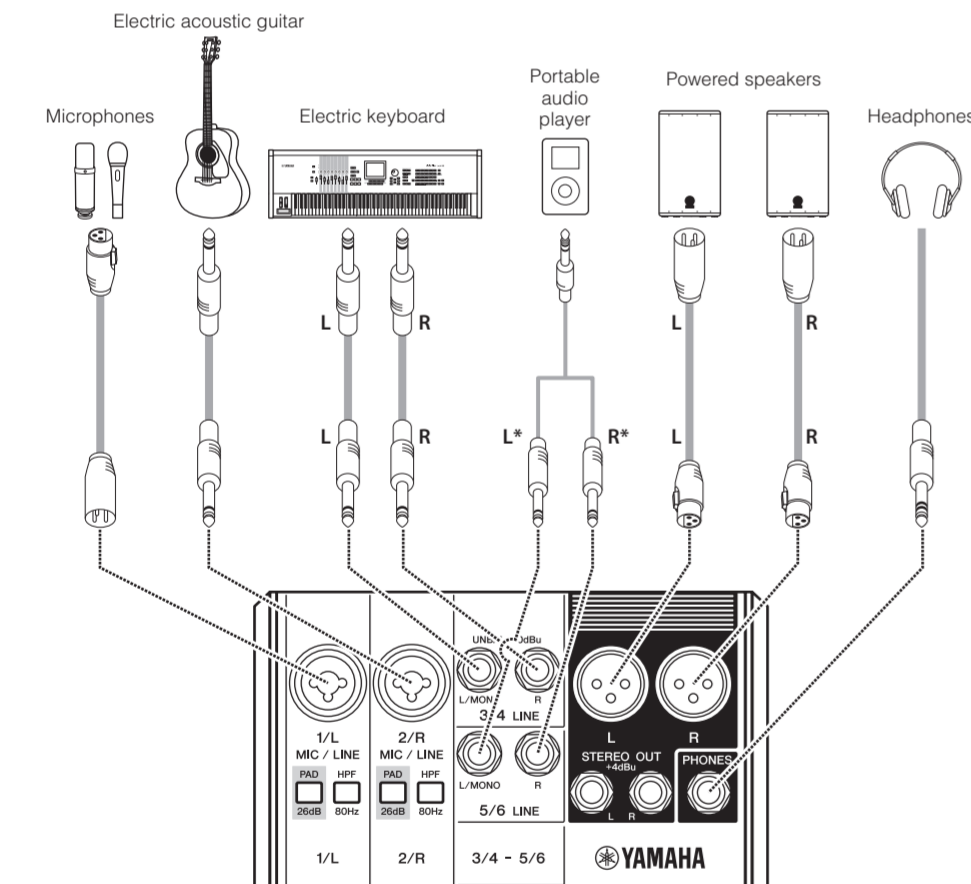

* Stereo mini plugs require conversion plugs to phone plugs.

STEP 2 Getting Sound to the Speakers

1 Make sure that all switches including the [ON] switch are not pressed (■).

2 Connect the supplied AC power adaptor.

First connect the adaptor to the DC IN [12V] jack at the back panel of the unit (1), and then to the outlet (2).

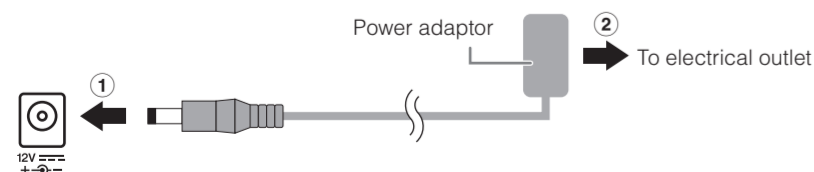

3 Turn the [GAIN], [LEVEL] knobs (white), and [STEREO LEVEL] knob (red) fully to the left (minimum). Set the equalizer knobs (green) to the center "0" position.

Refer to the illustration (at the top of the next column, before step 4). ↗

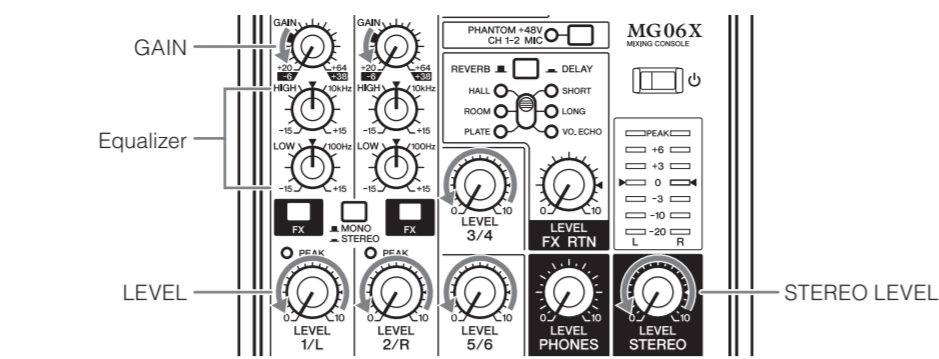

4 If you connect a device with high output level, such as a CD player or an electric keyboard to the channels 1/L and 2/R, turn on (▲) the [PAD] switch of the corresponding channel*.

* Channel: Location or path where sound is input.

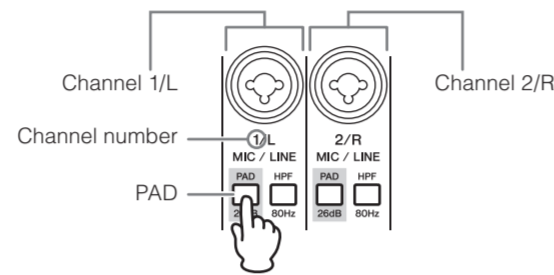

NOTE If you are using condenser microphones, turn on (▲) the [PHANTOM +48V] switch.

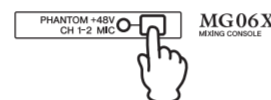

5 Turn on the power to connected devices in the following order: (🎤) (microphone), (🎸) (instrument), (🎧) (audio device) ➡ (🔊) (switch on unit) ➡ (🔊) (speakers)

NOTICE Follow this order to avoid any loud, unexpected noise from the speakers. Reverse the order when turning the power off.

6 Set the [STEREO LEVEL] knob to the "4" position.



7 For channels to which a microphone is connected, set the [GAIN] knob to roughly the 12 o'clock position.

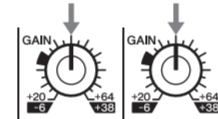

8 While playing your instrument or speaking into the microphone, turn the [LEVEL] knob to adjust the volume of the corresponding channel.

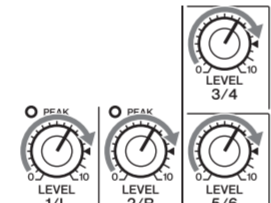

9 If necessary, adjust the volume of the speaker or power amp.

If you hear the sound and the volume seems appropriate, setup is complete. If not, please go to step 10 below.

NOTICE To avoid any loud noise from the speaker, first turn off the power of the speaker (speaker amp), then the unit itself, and finally the connected sound source such as an instrument.

10 If the sound is not heard, or if you want to adjust the volume, follow the instructions in the boxed section below.

If you still do not hear the sound after doing the following steps, please refer to the checklist in the "Troubleshooting" section at the back of this booklet.

■ There is no sound, or you need to increase the volume

1 Turn the [GAIN] knob to the right so that the corresponding [PEAK] LED flashes briefly.

NOTE If the [PEAK] LED does not light even if the [GAIN] knob has been turned fully to the right, raise the volume of the sound source (instrument, etc.).

If no sound is heard or the volume does not increase after step 1:

2 If the [PAD] switch is turned on (▲), set the [LEVEL] knob to "0" (minimum), and then turn off (■) the switch.

3 Slowly turn the [LEVEL] knob to the right until the desired volume is reached.

■ To decrease the volume:

1 Set the [LEVEL] knob to "0" (minimum), then turn on (▲) the [PAD] switch.

2 Slowly turn the [LEVEL] knob to the right until the desired volume is reached.

If the volume does not decrease after the above steps:

3 Lower the volume of the instrument or audio device.

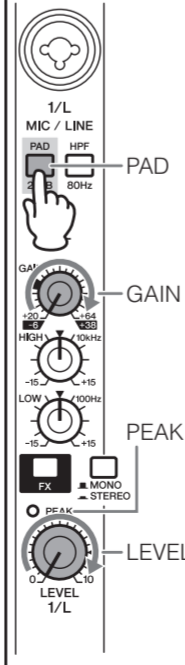

Mixer Basics: Where Your Sound Goes

The right illustration diagram illustrates the sound flow from summing (mixing) sound which was input to the channels to outputting sound from the speakers or headphones. Let's find out where input sound goes once it's inside the mixer.

1 Input the sound from a microphone or instrument

2 Adjust the tone and volume of each channel

GAIN, LEVEL Knobs
Equalizer (HIGH, LOW) knobs

3 The signal flow of the sound rightward, from the channels to the final output.

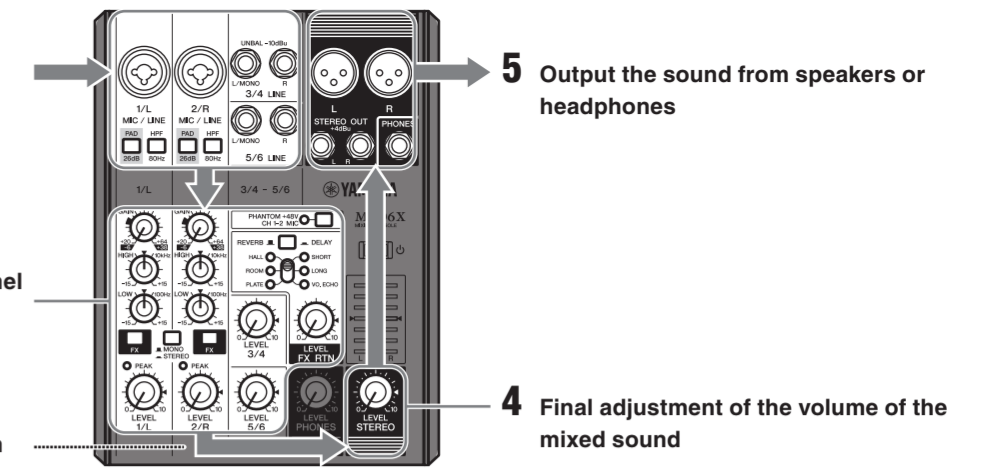

5 Output the sound from speakers or headphones

4 Final adjustment of the volume of the mixed sound

Applying Effects (MG06X)

The MG06X features built-in effects (Reverb and Delay) processors that are in the same league as our famed SPX effect processor series. Those effects let you simulate the acoustics of different performance environments, such as concert halls and small clubs, and add warm, natural ambience to your vocals or instrument performance.

1 Use the [REVERB] / [DELAY] switch to select Reverb (■) or Delay (▲).

Type		Description
REVERB	HALL	Reverb simulating a large space such as a concert hall.
	ROOM	Reverb simulating the acoustics of a small space (room).
	PLATE	Reverb simulating a metal-plate, producing a more hard-edged sound.
DELAY	SHORT	Short echo with a "doubled" sound.
	LONG	Long, resonant echo with an extended decay.
	VO.ECHO	Echo suitable for vocals.

2 Move the effect select slide switch up and down to select the effect type. The LED of the selected effect lights.

3 Turn on (▲) the [FX] switch of the channel (1/L or 2/R) to which you want to apply the effect.

4 Turn the [FX RTN LEVEL] knob to adjust the effect amount.

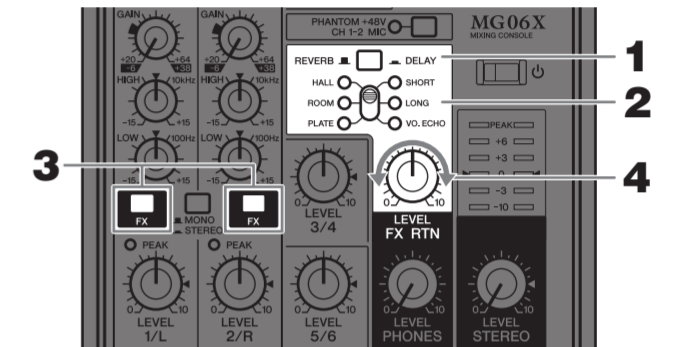

Controls and Functions

1 (Back panel) DC IN [12V] jack

Connect the supplied AC power adaptor to this jack.

2 [MIC/LINE] mono input jacks (channels 1/L, 2/R)

Connect a microphone, an instrument, or an audio device (CD player, etc.) to the unit. These jacks support both XLR and phone plugs.



3 [LINE] stereo input jacks (channels 3/4, 5/6)

Connect line-level devices such as an electric keyboard or an audio device. These jacks support phone plugs. If you use only the [L/MONO] jack, same sound is output from both L (left) and R (right) speakers.

4 [PAD] switches

Turning the switch on (▲) will attenuate the sound input to the unit. If you hear distortion or the [PEAK] LED lights, turn the switch on (▲).

NOTE Turn the [LEVEL] knob to "0" (minimum) before toggling the [PAD] switch on (▲) and off (■). Otherwise, noise may be produced.

5 [HPF] (High-Pass Filter) switches

Turning the switch on (▲) will apply a high-pass filter that attenuates frequencies below 80Hz. When speaking into the microphone, you may want to turn this switch on (▲), in order to reduce unwanted vibration and wind sound received by the microphone.

8 [GAIN] knobs

Determines the basic volume for each channel, 1/L and 2/R. Adjust these so that the corresponding [PEAK] LEDs flash briefly when singing or playing the loudest.

9 Equalizer (EQ) knobs

Adjust the tone by using the [HIGH] (high frequency band) and [LOW] (low frequency band) knobs. If you do not need to adjust the tone, set the knob to the "0" (flat) position.

10 [FX] switches (MG06X)

Toggle the FX (effect) of channels 1/L and/or 2/R on and off.

11 [MONO] / [STEREO] switch

[MONO]: Sound input to channels 1/L or 2/R can be heard from both the right and left speakers. If you use the 1/L or 2/R individually, set the switch to this setting.

[STEREO]: Sound input to channel 1/L can be heard from only the left speaker, and that input to channel 2/R can be heard from only the right speaker.

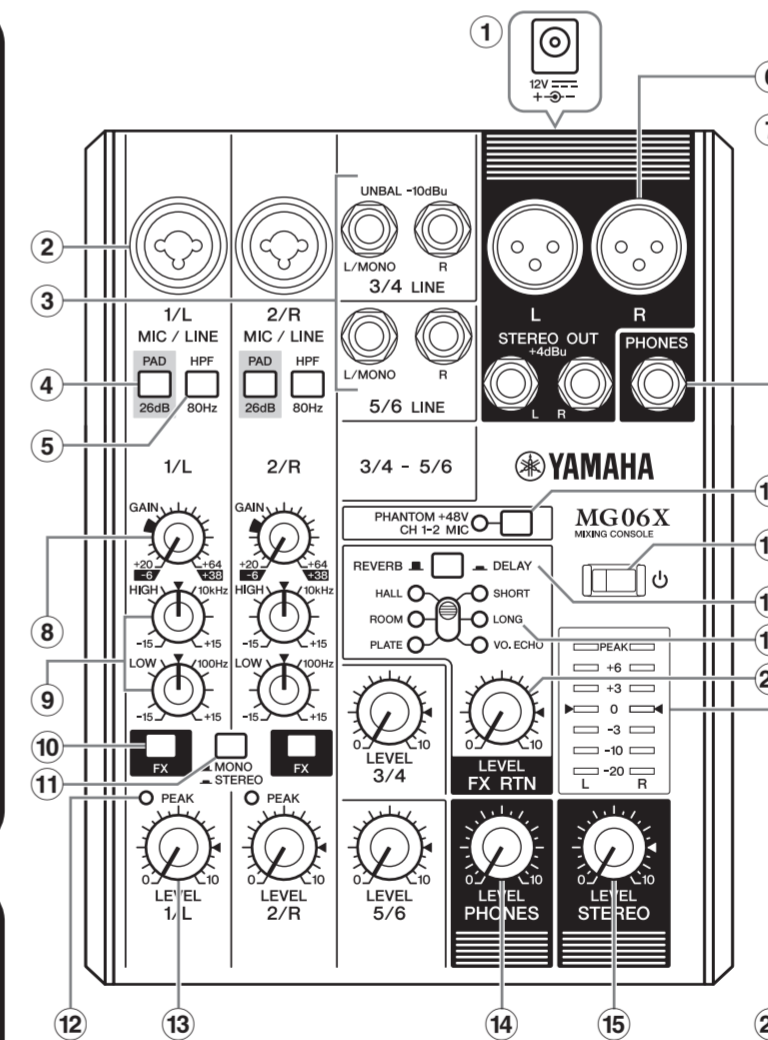

12 [PEAK] LED

Lights when the volume of input and/or post-equalizer sound is too high. If it is lit, turn the [GAIN] knob (8) to the left to lower the volume.

13 [LEVEL] knobs

For adjusting the volume balance among the channels.

14 [PHONES LEVEL] knob

Adjusts the headphones volume.

15 [STEREO LEVEL] knob

Adjusts the overall volume output from the [STEREO OUT] output jacks.

6 [STEREO OUT] output jacks

Connect a powered speaker or powered amp. These jacks support both XLR and phone plugs.

7 [PHONES] output jack

Connect a set of headphones. This jack supports a stereo phone plug.

16 [PHANTOM +48V] switch/LED

When this switch is on (▲), the LED lights indicating that the unit supplies DC+48V phantom power to the XLR plugs of the [MIC/LINE] mono input jacks (2). Turn this switch on when using a phantom-powered condenser microphone.

⚠ CAUTION

Be sure to leave this switch off (■) if you do not need phantom power. Follow the important precautions below, in order to prevent noise and possible damage to external devices as well as the unit when you operate this switch.

- Be sure to leave this switch off when you connect a device that does not support phantom power to channels 1/L or 2/R.
- Do not connect/disconnect a cable to/from channels 1/L and 2/R while this switch is on.
- Turn the [LEVEL] knob of the channels 1/L and 2/R to the minimum before operating this switch.

17 [ON/Standby] switch

Toggles to turn the unit's power On (▲) or Standby (■).

⚠ CAUTION

Rapidly switching the unit between on and standby in succession can cause it to malfunction. After setting the unit to standby, wait for about 5 seconds before turning it on again.

Even when the switch is in the standby (■) position, electricity is still flowing to the unit. If you do not plan to use the unit for a while, be sure to unplug the AC power adaptor from the outlet.

18 [REVERB] / [DELAY] switch (MG06X)

Toggles to select the effect applied to channels 1/L and 2/R between Reverb (■) and Delay (▲).

19 Effect select slide switch (MG06X)

Moves up and down to select the effect type. The LED of the selected effect lights.

20 [FX RTN LEVEL] (effect return level) knob (MG06X)

Adjusts the volume of the effect sound.

21 Level meter

The L and R meters show the level of the signal output from the [STEREO OUT] jack. If the [PEAK] lamp lights in red, use the [LEVEL] knob to lower the volume.

Troubleshooting

Power does not come on.

- Did you properly plug the power adaptor into an appropriate AC outlet?
- Did you firmly and securely connect the power plug?

No sound.

- Did you turn on the powered speaker or the power amp?
- Did you properly connect the microphones, external devices, and speakers?
- Are any connecting cables shorted or damaged?
- Did you properly set the [LEVEL] knobs of all relevant channels and the [STEREO LEVEL] knob to appropriate levels?
- Are the [PAD] switches turned on (■)?
 - Turn the switch off (■). If the volume of sound source is too soft, turning on the switch may result in no audible sound.

Sound is faint, distorted, or noisy.

- Are the [GAIN] knobs and [LEVEL] knobs of all relevant channels, and the [STEREO LEVEL] knob set too high?
- Are the [PEAK] LEDs lit?
 - Lower the [GAIN] knobs of channels 1/L and 2/R, or turn on (▲) the [PAD] switches.
- Are the "PEAK" (red) lamps of the level meter lit?
 - Set the [LEVEL] knobs of all relevant channels and the [STEREO LEVEL] knob to appropriate levels.
- Are the [PAD] switches turned off (■)?
 - Turn the switches on (▲). If the volume of sound source is too loud, turning off the switches may result in distorted sound.
- Is the volume from the connected device too loud?
 - Lower the volume of the connected device.

The sound of vocals and speech isn't clear enough.

- Turn on (▲) the [HPF] switches.
 - The sound becomes clearer.
- Adjust the equalizer knobs (example: lower the [LOW] knobs, raise the [HIGH] knobs).

No effect is applied. (MG06X)

- Did you turn on (▲) the [FX] switches?
- Are the [LEVEL] knobs of all relevant channels raised enough?
- Did you set the [FX RTN LEVEL] knob to an appropriate level?

Mounting to a Microphone Stand

Caution

- If the stand should fall over, the mixer may be damaged. Attach the connection cables carefully so that the cables will not catch on the equipment and cause it to fall. For example: arrange the cables so that they run parallel with the microphone pole down to the base of the stand.

Notice

- When using the mixer on a microphone stand, be sure to set the stand on a level and stable surface. Do not set up the stand in locations subject to vibrations or wind.
- Leave ample free space around the stand.

- Turn the mixer upside-down, and hold the third-party's microphone-stand adaptor (*1) against the bottom of the mixer so that the screw holes are aligned (1). Screw the adaptor firmly into place with the two screws (2).**

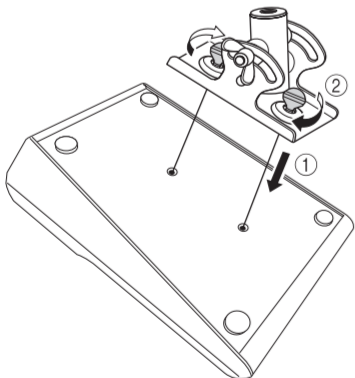

- Turn the mixer right-side up, and mount it onto your microphone stand.**

- Loosen the angle adjustment wingnut (1), adjust the mixer's angle as desired (2), and then tighten the wingnut securely (3).**

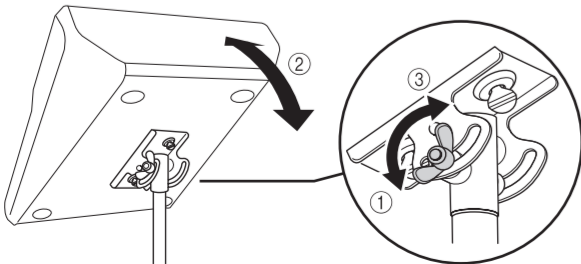

*1 For information on available third-party accessories, please refer to the Yamaha Pro Audio website. <https://www.yamahaproaudio.com/>

General Specifications

0 dBu = 0.775 Vrms Output impedance of signal generator (Rs) = 150 Ω
All level knobs are nominal if not specified.

Frequency Response	Input to STEREO OUT	+0.5 dB/-0.5 dB (20 Hz to 20 kHz), refer to the nominal output level @ 1 kHz, GAIN knob: Min
Total Harmonic Distortion (THD+N)	Input to STEREO OUT	0.01 % @ +8 dBu (20 Hz to 20 kHz), GAIN knob: Min
	Input to STEREO OUT	0.003 % @ +18 dBu (1 kHz), GAIN knob: Min
Hum&Noise *1 (20 Hz to 20 kHz)	Equivalent Input Noise	-128 dBu (Mono Input Channel, Rs: 150Ω, GAIN knob: Max)
Crosstalk (1 kHz) *2	Residual Output Noise	-102 dBu (STEREO OUT, STEREO LEVEL knob: Min)
		-88 dB
Input Channels		6 channels: Mono (MIC/LINE): 2, Stereo (LINE): 2
Output Channels		STEREO OUT: 2, PHONES: 1
Bus		STEREO: 1
Mono Input Channel Function	PAD	26 dB
	HPF	80 Hz, 12 dB/oct
	EQ HIGH	Gain: +15 dB/-15 dB, Frequency: 10 kHz shelving
	EQ LOW	Gain: +15 dB/-15 dB, Frequency: 100 Hz shelving
	PEAK LED	LED turns on when post EQ signal reaches 3 dB below clipping (+11 dBu)
Level Meter	Post STEREO LEVEL Knob	2 x 7-segment LED meter (PEAK (+11), +6, +3, 0, -3, -10, -20 dB)
Internal Digital Effect (MG06X)	SPX Algorithm	6 programs
Phantom Power Voltage		+48 V
Power Supply Adaptor		PA-130 (DC12 V/1.0 A, Cable length = 1.8 m), 120 V, 60 Hz, or MU18 (DC12 V/1.5 A, Cable length = 1.5 m), 100 V-240 V, 50 Hz/60 Hz, or an equivalent recommended by Yamaha
Power Consumption		12 W
Dimensions (WxHxD)		149 mmx62 mmx202 mm (5.9"x 2.4"x 7.9")
Net Weight		MG06: 0.9 kg (2.0 lbs), MG06X: 0.9 kg (2.0 lbs)
Optional Accessory		Third-party mic stand adapter *3
Operating Temperature		0 to +40°C

* 1 Noise is measured with A-weighting filter.

* 2 Crosstalk is measured with 1 kHz band pass filter.

* 3 For information on available third-party accessories, please refer to the Yamaha Pro Audio website. <https://www.yamahaproaudio.com/>

* The contents of this manual apply to the latest specifications as of the publishing date. To obtain the latest manual, access the Yamaha website then download the manual file.

Jack List (Pin Alignment)

Input and Output Jacks	Polarities	Balanced/Unbalanced	Configurations
MIC/LINE 1/L, 2/R STEREO OUT L, R	Pin 1: Ground Pin 2: Hot (+) Pin 3: Cold (-)	Balanced	XLR connector
MIC/LINE 1/L, 2/R* STEREO OUT L, R*	Tip: Hot (+) Ring: Cold (-) Sleeve: Ground	Balanced	TRS phone plug
PHONES	Tip: L Ring: R Sleeve: Ground	—	TS phone plug
LINE 3/4, 5/6	Tip: Signal Sleeve: Ground	Unbalanced	TS phone plug

* These jacks also accept connection to TS phone plugs. If you use TS phone plugs, the connection will be unbalanced.

NOTICE

To avoid the possibility of malfunction/ damage to the product, damage to data, or damage to other property, follow the notices below.

Handling and Maintenance

- Do not use the device in the vicinity of a TV, radio, stereo equipment, mobile phone, or other electric devices. Otherwise, the device, TV, or radio may generate noise.
- Do not expose the device to excessive dust or vibration, or extreme cold or heat (such as in direct sunlight, near a heater, or in a car during the day), in order to prevent the possibility of panel disfiguration, unstable operation, or damage to the internal components.
- Do not place vinyl, plastic or rubber objects on the device, since this might discolor the panel.
- When cleaning the device, use a dry and soft cloth. Do not use paint thinners, solvents, cleaning fluids, or chemical-impregnated wiping cloths.
- Condensation can occur in the device due to rapid, drastic changes in ambient temperature—when the device is moved from one location to another, or air conditioning is turned on or off, for example. Using the device while condensation is present can cause damage. If there is reason to believe that condensation might have occurred, leave the device for several hours without turning on the power until the condensation has completely dried out.
- To avoid generating unwanted noise, make sure there is adequate distance between the AC power adaptor and the device.
- Avoid setting all equalizer and level knobs to their maximum. Depending on the condition of the connected devices, doing so may cause feedback and may damage the speakers.
- When turning on the AC power in your audio system, always turn on the power amplifier LAST, to avoid speaker damage. When turning the power off, the power amplifier should be turned off FIRST for the same reason.
- Always turn the power off when the device is not in use.

Connectors

XLR-type connectors are wired as follows (IEC60268 standard): pin 1: ground, pin 2: hot (+), and pin 3: cold (-).

Information

About this manual

- The illustrations as shown in this manual are for instructional purposes only, and may appear somewhat different from those on your device.
- The company names and product names in this manual are the trademarks or registered trademarks of their respective companies.

The model number, serial number, power requirements, etc., may be found on or near the name plate, which is at the bottom of the unit. You should note this serial number in the space provided below and retain this manual as a permanent record of your purchase to aid identification in the event of theft.

Model No. _____

Serial No. _____

(bottom_en_01)

PRECAUTIONS

PLEASE READ CAREFULLY BEFORE PROCEEDING

Please keep this manual in a safe place for future reference.

WARNING

Always follow the basic precautions listed below to avoid the possibility of serious injury or even death from electrical shock, short-circuiting, damages, fire or other hazards. These precautions include, but are not limited to, the following:

Power supply/AC power adaptor

- Do not place the power cord near heat sources such as heaters or radiators, and do not excessively bend or otherwise damage the cord, place heavy objects on it, or place it in a position where anyone could walk on, trip over, or roll anything over it.
- Only use the voltage specified as correct for the device. The required voltage is printed on the name plate of the device.
- Use the specified adaptor (MU18 or PA-130, or an equivalent recommended by Yamaha) only. Using the wrong adaptor can result in damage to the instrument or overheating.
- If you intend to use the device in an area other than in the one you purchased, the included power adaptor may not be compatible. Please check with your Yamaha dealer.
- Check the electric plug periodically and remove any dirt or dust which may have accumulated on it.

Do not open

- This device contains no user-serviceable parts. Do not open the device or attempt to disassemble the internal parts or modify them in any way. If it should appear to be malfunctioning, discontinue use immediately and have it inspected by qualified Yamaha service personnel.

Water warning

- Do not expose the device to rain, use it near water or in damp or wet conditions, or place on it any containers (such as vases, bottles or glasses) containing liquids which might spill into any openings. If any liquid such as water seeps into the device, turn off the power immediately and unplug the power cord from the AC outlet. Then have the device inspected by qualified Yamaha service personnel.
- Never insert or remove an electric plug with wet hands.

Fire warning

- Do not put burning items, such as candles, on the unit. A burning item may fall over and cause a fire.

If you notice any abnormality

- When one of the following problems occur, immediately turn the power off and disconnect the electric plug from the outlet. Then have the device inspected by Yamaha service personnel.
 - The power cord or plug becomes frayed or damaged.
 - It emits unusual smells or smoke.
 - Some object has been dropped into the instrument.
 - There is a sudden loss of sound during use of the device.
- If this device or the AC power adaptor should be dropped or damaged, immediately turn the power off, disconnect the electric plug from the outlet, and have the device inspected by qualified Yamaha service personnel.

CAUTION

Always follow the basic precautions listed below to avoid the possibility of physical injury to you or others, or damage to the device or other property. These precautions include, but are not limited to, the following:

Power supply/AC power adaptor

- Do not cover or wrap the AC power adaptor with a cloth or blanket.
- When removing the electric plug from the device or an outlet, always hold the plug itself and not the cord. Pulling by the cord can damage it.
- Remove the electric plug from the outlet when the device is not to be used for extended periods of time, or during electrical storms.

Location

- Do not place the device in an unstable position where it might accidentally fall over.
- Do not place the device in a location where it may come into contact with corrosive gases or salt air. Doing so may result in malfunction.
- Before moving the device, remove all connected cables.
- When setting up the device, make sure that the AC outlet you are using is easily accessible. If some trouble or malfunction occurs, immediately turn the power off and disconnect the plug from the outlet. Even when the power is turned off, electricity is still flowing to the product at the minimum level. When you are not using the product for a long time, make sure to unplug the power cord from the wall AC outlet.

Connections

- Before connecting the device to other devices, turn off the power for all devices. Before turning the power on or off for all devices, set all volume levels to minimum.

Maintenance

- Remove the power plug from the AC outlet when cleaning the device.

Handling caution

- Avoid inserting or dropping foreign objects (paper, plastic, metal, etc.) into any gaps or openings on the device. If this happens, turn off the power immediately and unplug the power cord from the AC outlet. Then have the device inspected by qualified Yamaha service personnel.
- Do not rest your weight on the device or place heavy objects on it, and avoid use excessive force on the buttons, switches or connectors.
- Do not use speakers or headphones for a long period of time at a high or uncomfortable volume level, since this can cause permanent hearing loss. If you experience any hearing loss or ringing in the ears, consult a physician.

Yamaha cannot be held responsible for damage caused by improper use or modifications to the device, or data that is lost or destroyed.

Always turn the power off when the device is not in use. Even when the (Standby/On) switch is in standby status, electricity is still flowing to the instrument at the minimum level. When you are not using the instrument for a long time, make sure you unplug the power cord from the wall AC outlet.

European Models
Inrush Current based on EN 55103-1:2009
1 A (on initial switch-on)
1 A (after a supply interruption of 5s)
Conforms to Environments: E1, E2, E3 and E4

(PA-en_1)

Information for Users on Collection and Disposal of Old Equipment

This symbol on the products, packaging, and/or accompanying documents means that used electrical and electronic products should not be mixed with general household waste. For proper treatment, recovery and recycling of old products, please take them to applicable collection points, in accordance with your national legislation and the Directives 2002/96/EC.

By disposing of these products correctly, you will help to save valuable resources and prevent any potential negative effects on human health and the environment which could otherwise arise from inappropriate waste handling.

For more information about collection and recycling of old products, please contact your local municipality, your waste disposal service or the point of sale where you purchased the items.

[For business users in the European Union]

If you wish to discard electrical and electronic equipment, please contact your dealer or supplier for further information.

[Information on Disposal in other Countries outside the European Union]

This symbol is only valid in the European Union. If you wish to discard these items, please contact your local authorities or dealer and ask for the correct method of disposal.

(weee_eu_en_01)

IMPORTANT NOTICE FOR THE UNITED KINGDOM Connecting the Plug and Cord

IMPORTANT: The wires in this mains lead are coloured in accordance with the following code:

BLUE : NEUTRAL
BROWN : LIVE

As the colours of the wires in the mains lead of this apparatus may not correspond with the coloured markings identifying the terminals in your plug proceed as follows:
The wire which is coloured BLUE must be connected to the terminal which is marked with the letter N or coloured BLACK.
The wire which is coloured BROWN must be connected to the terminal which is marked with the letter L or coloured RED.
Making sure that neither core is connected to the earth terminal of the three pin plug.

(2 wires)

FCC INFORMATION (U.S.A.)

1. IMPORTANT NOTICE: DO NOT MODIFY THIS UNIT!

This product, when installed as indicated in the instructions contained in this manual, meets FCC requirements. Modifications not expressly approved by Yamaha may void your authority, granted by the FCC, to use the product.

2. IMPORTANT:

When connecting this product to accessories and/or another product use only high quality shielded cables. Cable/s supplied with this product MUST be used. Follow all installation instructions. Failure to follow instructions could void your FCC authorization to use this product in the USA.

3. NOTE:

This product has been tested and found to comply with the requirements listed in FCC Regulations, Part 15 for Class "B" digital devices. Compliance with these requirements provides a reasonable level of assurance that your use of this product in a residential environment will not result in harmful interference with other electronic devices. This equipment generates/uses radio frequencies and, if not installed and used according to the instructions found in the users manual, may cause interference harmful to the operation of other electronic devices. Compliance with FCC regulations does not guarantee that interference will not occur in all installations. If this product is found to be the source of interference, which can be determined by turning the unit "OFF" and "ON", please try to eliminate the problem by using one of the following measures:
Relocate either this product or the device that is being affected by the interference.
Utilize power outlets that are on different branch (circuit breaker or fuse) circuits or install AC line filter/s.
In the case of radio or TV interference, relocate/reorient the antenna. If the antenna lead-in is 300 ohm ribbon lead, change the lead-in to co-axial type cable.
If these corrective measures do not produce satisfactory results, please contact the local retailer authorized to distribute this type of product. If you can not locate the appropriate retailer, please contact Yamaha Corporation of America, Electronic Service Division, 6600 Orangethorpe Ave, Buena Park, CA90620.
The above statements apply ONLY to those products distributed by Yamaha Corporation of America or its subsidiaries.

* This applies only to the MG06X distributed by YAMAHA CORPORATION OF AMERICA.

(class B)

이 기기는 가정용(B급) 전자파적합기기로서 주로 가정에서 사용하는 것을 목적으로 하며, 모든 지역에서 사용할 수 있습니다.

(class b Korea)

OBSERVERA!

Apparaten kopplas inte ur växelströmskällan (nätet) så länge som den är ansluten till vägguttaget, även om själva apparaten har stängts av.

ADVARELS:

Nettspændingen til dette apparat er IKKE afbrudt, så længe netledningen sidder i en stikkontakt, som er tændt — også selvom der er slukket på apparatets afbryder.

VAROITUS:

Laiteen toisipiiriin kytketty käyttökytkin ei irroita koko laitetta verkosta.

(standby)

Yamaha Worldwide Representative Offices

English

For details on the product(s), contact your nearest Yamaha representative or the authorized distributor, found by accessing the 2D barcode below.

Deutsch

Wenden Sie sich für nähere Informationen zu Produkten an eine Yamaha-Vertretung oder einen autorisierten Händler in Ihrer Nähe. Diese finden Sie mithilfe des unten abgebildeten 2D-Strichcodes.

Français

Pour obtenir des informations sur le ou les produits, contactez votre représentant ou revendeur agréé Yamaha le plus proche. Vous le trouverez à l'aide du code-barres 2D ci-dessous.

Español

Para ver información detallada sobre el producto, contacte con su representante o distribuidor autorizado Yamaha más cercano. Lo encontrará escaneando el siguiente código de barras 2D.

Italiano

Per dettagli sui prodotti, contattare il rappresentante Yamaha o il distributore autorizzato più vicino, è possibile trovare tramite il codice a barre 2D in basso.

Português

Para mais informações sobre o(s) produto(s), fale com seu representante da Yamaha mais próximo ou com o distribuidor autorizado acessando o código de barras 2D abaixo.

Русский

Чтобы узнать подробнее о продукте (продуктах), свяжитесь с ближайшим представителем или авторизованным дистрибьютором Yamaha, воспользовавшись двумерным штрихкодом ниже.

简体中文

如需有关产品的详细信息, 请联系距您最近的Yamaha代表或授权经销商, 可通过访问下方的2D条形码找到这些代表或经销商的信息。

繁體中文

如需產品的詳細資訊, 請聯絡與您距離最近的Yamaha銷售代表或授權經銷商, 您可以掃描下方的二維條碼查看相關聯絡資料。

한국어

제품에 대한 자세한 정보는 아래 2D 바코드에 액세스하여 가까운 Yamaha 담당 판매점 또는 공식 대리점에 문의하십시오.



https://manual.yamaha.com/pa/address_list/

Head Office/Manufacturer: Yamaha Corporation 10-1, Nakazawa-cho, Chuo-ku, Hamamatsu, 430-8650, Japan
Importer (European Union): Yamaha Music Europe GmbH Siemensstrasse 22-34, 25462 Rellingen, Germany
Importer (United Kingdom): Yamaha Music Europe GmbH (UK) Sherbourne Drive, Tilbrook, Milton Keynes, MK7 8BL, United Kingdom

PA61

Yamaha Pro Audio global website

<https://www.yamahaproaudio.com/>

Yamaha Downloads

<https://download.yamaha.com/>

© 2013 Yamaha Corporation
Published 03/2024 MWEM-DO