



INTERNAL **SCSI**  
E-IDE/ATAPI

**CD-R/RW DRIVE**  
**CRW2200S SERIES**

**20x 10x 40x**  
**CD-R CD-RW CD-ROM**



# OWNER'S MANUAL

# SAFETY PRECAUTIONS

## ***PLEASE READ CAREFULLY BEFORE PROCEEDING***

These precautions explain how to use the device correctly and safely, thereby preventing injury to yourself or to others. This section has been sub-divided into a WARNING section and a CAUTION section, according to the likelihood and nature of any potential injuries or damage inflicted. They relate to your personal safety, and also help you minimize the risk of damaging the device. Please read these sections carefully before proceeding.



## **WARNING**

**Always follow the basic precautions listed below to avoid the possibility of serious injury or even death from electrical shock, short-circuiting, damages, fire, or other hazards. These precautions include, but are not limited to, the following:**

- Do not open the device or attempt to disassemble or modify it.  
Otherwise, there is an increased risk of electrical shock or fire. The device contains no user-serviceable parts. If it appears to be malfunctioning, have it inspected by qualified service personnel.
- Do not look inside the device.  
If you expose your eyes to the laser inside the device, you risk damage to or loss of your vision.
- Do not insert fingers or foreign objects into the device.  
Otherwise, there is an increased risk of personal injury, electrical shock, damage to the device, or fire. Please take particular care if small children are present.
- Do not expose the device to rain or use it near water or in damp or wet conditions. Do not place containers on it that contain liquids which might spill into any openings.  
Otherwise, there is an increased risk of electrical shock, fire, or personal injury.
- Follow the Owner's Manual carefully.  
Otherwise, there is an increased risk of personal injury, electrical shock, fire, or damage to the unit. Follow the correct procedure when setting up the device.
- If unusual smells, sounds, or smoke emanate from the device, or if liquids enter the device, switch the computer off immediately and unplug it from the power outlet.  
Otherwise, there is an increased risk of electrical shock, fire, or damage to the device. Return the device immediately to the store where it was purchased, or alternatively, to the nearest Yamaha dealer (listed at the back of this manual).
- Make sure the computer is electrically grounded.  
Otherwise, there is an increased risk of electrical shock.
- When opening up the computer, always unplug the computer from the electrical outlet. Do not touch the plug with wet hands.  
Otherwise, there is an increased risk of electrical shock.
- When used in a fan-cooled system, the drive should not be exposed to temperatures outside the range 5 – 40°C (41 – 104°F).



## CAUTION

---

**Always follow the basic precautions listed below to avoid the possibility of physical injury to yourself or others, or damage to the instrument or other property. These precautions include, but are not limited to, the following:**

- Always unplug the computer from the electrical outlet if it will not be used for a prolonged period of time, or if there is a risk of lightning.  
Otherwise, there is an increased risk of electrical shock, short-circuiting, or fire.
- Do not expose the device to excessive heat or vibrations, such as in areas subject to direct sunlight or near a heater.  
Also avoid placing it in extreme cold or in areas subject to excessive dust.  
Otherwise, the front panel may become disfigured or the internal components may be damaged.
- Do not use the device near other electrical products such as televisions, radios, or speakers.  
Otherwise, this may cause interference which can affect the proper operation of those other products.
- Do not place the device in an unstable position.  
Otherwise, it may accidentally fall down and be damaged or cause personal injury.
- Mount the device horizontally.  
Otherwise, written data may be destroyed. Set the device up according to the instructions in the Owner's Manual.
- Always remove the disc from the tray before transporting the device.  
Otherwise, written data may be destroyed.
- When cleaning the device, never use benzene, paint thinners, detergents, or chemically coated wiping cloths. Also, do not place vinyl, plastic, or rubber objects on the device.  
Otherwise, the device may be damaged or its front panel may become discolored. Use a soft, dry cloth to wipe the device.
- Do not rest your weight on or place heavy objects on the device and do not use excessive force on the buttons, switches or connectors.  
Otherwise, there is an increased risk of damage to the device or personal injury.
- Do not listen to audio with headphones at high volume or for prolonged periods of time.  
Otherwise, there is an increased risk of hearing loss.
- Before using the device, set the volume dial to its lowest setting.  
Otherwise, sudden bursts of sound can cause hearing loss.
- Do not place the device near sources of magnetic interference, such as computer displays.  
Magnetic interference can affect the operation and stability of the device.
- Have the device serviced regularly.  
Otherwise, dust can build up inside the device, increasing the risk of fire or damage. For information about service charges, contact the store where the device was purchased, or alternatively, the nearest Yamaha dealer (listed at the back of this manual). The device should be serviced about once a year.
- This drive is for use only with movable equipment, weighing less than 18 kg.

## ■ About CD-R/RW discs

Please read the following regarding the handling of CD-R/RW discs.

1. Do not expose discs to excessive heat, such as in areas subject to direct sunlight or near a heater.  
Also, avoid keeping them in a humid place.
2. Do not touch the surface of a disc.  
When handling a disc, hold it by its edges.
3. Remove dust and dirt from the surface of a disc.  
Use air-based dust removers. The surface of a disc may be scratched if wiped with a dry cloth.
4. Do not stick labels on the surface of a disc.
5. Do not write on the surface of a disc except where indicated.
6. Do not clean discs with chemicals or detergents.
7. Do not bend or drop discs.
8. Do not use irregularly shaped discs, such as a star or a heart or a card shaped, etc.  
Such discs could damage your new CD-R/RW drive. (Use only circular discs.)

1. **The information contained in this manual is subject to change without prior notice.**
2. **All trademarks contained in this manual belong to their respective owners.**
3. **Yamaha does not bear any responsibility for any outcome as a result of using this device.**
4. **Reproduction of this manual, either in part or in full, is expressly forbidden.**

## ■ Precautions for Transportation

Before transporting the device, always put it in its original box. If the device is transported without adequate packing, the internal components may be damaged and cause the device to malfunction.

## ■ Copyrights

When writing to CD-R/RW, make sure that you are not infringing any copyrights. It is illegal to copy audio CDs for non-personal use. When backing up software, please make sure that you are not infringing any software copyrights for that product.

## ■ WARRANTY

YAMAHA AND SUPPLIERS ACCEPT NO LIABILITY FOR THE LOSS OF ANY DATA OR ANY PROBLEMS CAUSED AS A RESULT. AS A PRECAUTION, IT IS RECOMMENDED THAT THE DISCS BE TESTED AFTER THEY HAVE BEEN WRITTEN TO. FURTHERMORE, UNDER NO CIRCUMSTANCES DOES YAMAHA AND SUPPLIERS GUARANTEE THE RELIABILITY OF THE DISCS.



# Table of Contents

<b>SCSI connection and E-IDE (ATAPI) connection</b> .....	<b>1</b>
<b>Introduction</b> .....	<b>2</b>
Features of the <b>CRW2200</b> drive .....	2
<b>Before Use</b> .....	<b>4</b>
System Requirements .....	4
Supported Discs .....	5
Serial Number .....	8
<b>Front and Rear of Unit</b> .....	<b>9</b>
Front Panel .....	9
Rear Panel (with the SCSI Converter) .....	10
Rear Panel (without the SCSI Converter) .....	11
<b>SCSI Connection Set Up</b> .....	<b>12</b>
Tools .....	12
<b>CRW2200S</b> Setup Flowchart .....	13
Connecting the <b>CRW2200S</b> .....	14
<b>Removing the SCSI convertor</b> .....	<b>32</b>
Tools .....	32
Removing the SCSI convertor .....	32
<b>E-IDE (ATAPI) Connection Set Up</b> .....	<b>35</b>
Tools .....	35
<b>CRW2200E</b> Setup Flowchart .....	36
Connecting the <b>CRW2200E</b> .....	37
<b>Operation</b> .....	<b>50</b>
Loading a Disc .....	50
Ejecting a Disc .....	50
Ejecting a Disc in an Emergency .....	51
<b>Troubleshooting</b> .....	<b>52</b>
<b>Appendix</b> .....	<b>57</b>
Writing Modes .....	57
About firmware .....	59
LED Indicator Messages .....	60
CRW2200 Specifications .....	60
Index .....	64

©2001 YAMAHA CORPORATION. All Rights Reserved.

This document may not, in whole or in part, be copied, photocopied, reproduced, translated, transmitted, or reduced to any electronic medium of machine readable form without prior consent in writing from Yamaha.

Windows is a registered trademark of Microsoft Corporation.

UNIX is a registered trademark of UNIX System Laboratories.

SafeBurn™ is a trademark of Yamaha Corporation.

All other trademarks are the property of their respective companies.



# SCSI connection and E-IDE (ATAPI) connection

The **CRW2200** drive enables you to set either a SCSI connection or an E-IDE (ATAPI) connection.

You can use the **CRW2200** drive as a SCSI device by attaching the SCSI convertor to the rear of the drive, you can also use the **CRW2200** drive as an E-IDE device by detaching the SCSI convertor.

Choose the connection method that applies to your computer environment.

## For SCSI Connection

→ “SCSI Connection Set Up” (P. 12 – 31)

Attach the SCSI convertor to the **CRW2200** drive.

In this manual, the drive plus the convertor is called the “**CRW2200S**.”

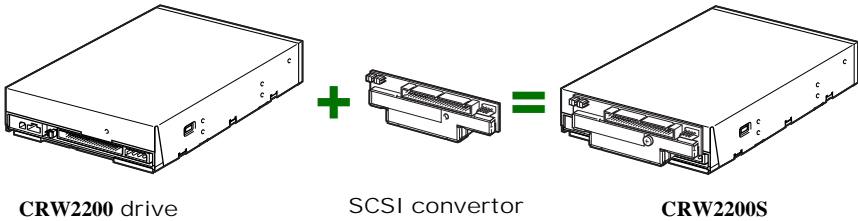

---

## Notes

- For a SCSI connection, use the following items (included).
  - SCSI convertor
  - Screw
  - Power cable
- The included SCSI convertor is for the **CRW2200** drive only. Do not use it with any other device. YAMAHA and its suppliers do not guarantee operation if it is used with any other device.

## For IDE Connection

→ “E-IDE (ATAPI) Connection Set Up” (P. 35 – 49)

Use the **CRW2200** drive only.

In this manual, it is called the “**CRW2200E**.”

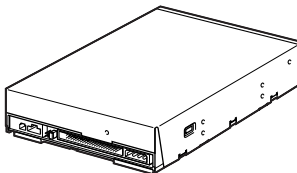

**CRW2200E**

# Introduction

## Features of the CRW2200 drive

### High speed writing/reading

---

The **CRW2200** drive supports up to 20X-speed writing of CD-R discs,<sup>\*1</sup> and up to 10X-speed writing/rewriting of CD-RW discs.<sup>\*2</sup> Furthermore, the drive supports data reading and digital audio data extraction at up to 40X speed.

### SafeBurn™ (Enhanced write stability technology)

---

- **Generous 8MB of buffer memory**

Because of the large data storage area, stable disc writing is possible even at fast speeds.

- **Buffer Underrun Protection**

When data transfer from the host PC is interrupted, Buffer Underrun Protection is activated to keep precious CD-R discs from going to waste. (→P. 3)

- **Optimum Write Speed Control**

Before writing to a CD-R, the **CRW2200** drive checks the disc's capability and automatically selects the optimum writing speed for greater reliability.

### Reliable writing

---

- **Yamaha's proprietary Pure-Phase Laser System (patent applied for)**

This technology reduces phase interference of the laser beam, so that it projects accurately onto the disc. Jitter value, an important measure of recording quality, has been improved 25% compared with Yamaha models not using this technology.

- **Running OPC (Optimum Power Control)**

Running OPC automatically adjusts the output of the laser according to the characteristics of the disc being used. Running OPC provides greatly enhanced recording reliability for various manufacturer's discs.

### High-fidelity digital audio

---

The **CRW2200** drive supports extraction of digital audio data at up to 40X speed, as well as the recording of digital sound with complete fidelity even when writing at 20X speed. Also, the built-in digital audio output is ideal for the pure transmission of an audio signal when connected to the SPDIF (digital audio) input of the computer's sound card.

### CD TEXT support

---

Information such as the song name or artist name can be recorded on Audio CDs using CD creation software. The text data on the created disc can be displayed on a CD player that is compatible with the CD TEXT format.

\*1 16X- or 20X-speed writing is enabled with the Partial CAV method. (→P. 6)

\*2 10X-speed writing/rewriting is enabled with the CLV method, and the 4X-10X Full CAV method. (→P. 7)

### Buffer Underrun Defined

CD-R/RW drives are equipped with buffer memory. This memory temporarily stores data while a disc is being recorded. When buffer memory becomes empty (due to unexpected interruptions or the system's inability to keep up with the writing process), a write error occurs. This error is known as a "buffer underrun error."

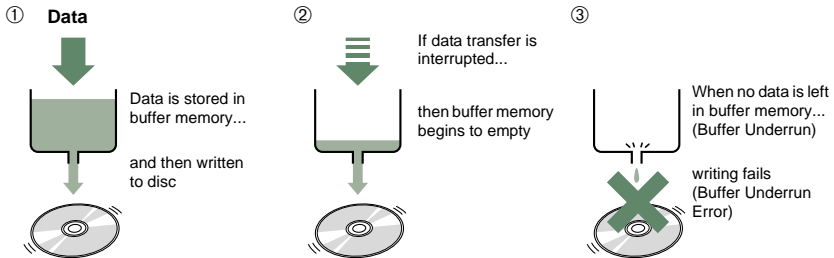

A Buffer Underrun Error will permanently ruin the disc.

### Yamaha Buffer Underrun Protection

Buffer Underrun Protection is featured in Yamaha's **CRW2200** series CD-R/RW drives. When a buffer underrun is about to occur, a buffer underrun error is prevented by temporarily suspending the writing process. Writing resumes when enough data has accumulated again in buffer memory. Buffer Underrun Protection on the **CRW2200** series is extremely accurate, resulting in seamless recording between stop and continuation points.

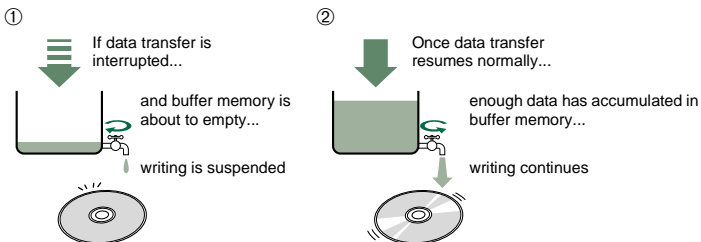

Yamaha Buffer Underrun Protection ensures error-free results.





# Before Use

## System Requirements

In order to use the **CRW2200** drive, your computer system will need to meet the following requirements.

---

### Note

The **CRW2200** drive may not write at the maximum speed depending on your computer's system configuration.

### PC/AT-Compatible Computer

CPU: Pentium II-class or higher, 300MHz or faster.

RAM: 32MB memory (64MB or more recommended).

---

### Note

If you are using Windows 2000 Professional operating system, you need 64MB memory or more.

A vacant 5.25-inch drive bay slot (For supplemental drive).

### These are also required for SCSI connection.

- A spare PCI expansion slot for a SCSI card (if one hasn't been installed yet).
- A PCI bus SCSI card (Ultra SCSI compatible with an internal SCSI connector, such as Adaptec's AHA-2940 series recommended).

---

### About SCSI cards

SCSI is a hardware interface that allows for the connection of peripheral devices to the computer. To use a computer without a SCSI connection, insert a SCSI card into the appropriate PCI slot on your computer. For information on how to install the SCSI card, refer to the documentation that came with it.

### Operating System (OS)

Windows 95 (OSR2 or later), Windows 98, Windows 98 Second Edition, Windows Me, Windows NT4.0 with Service Pack 3 or later, Windows 2000 Professional

### CD Writing Software

The **CRW2200** drive requires CD writing software to write onto a CD-R/RW disc.

When you use the CD writing software, make sure that it supports the **CRW2200** drive.

---

### Note

For details about how to install and use the software, refer to the documentation that came with it.

### Hard Drive Space

When writing to a CD-R/RW disc, you will need a working area (50 to 100MB free space) on the hard drive. If you want to create an image file containing all the data to be written to the CD-R/RW disc, in addition to the working area, you will need as much hard drive space as that data (up to 900MB in total). However, this additional hard drive space for the image file is not needed when you are writing directly from a hard drive or CD-ROM drive, etc. (on-the-fly writing).





---

### About disk image files

You can collect data files into a single disk image file for a CD-R/RW disc. Also, note that an image file is useful when writing multiple discs with the same content. For further details, refer to the documentation that came with your CD writing software.

## Supported Discs

The **CRW2200** drive can write to discs that carry the following logos:

	<p><b>CD-R discs</b><sup>*1</sup></p> <p>The <b>CRW2200</b> drive can write to these discs at 1X, 2X, 4X, 8X, 12X, 16X, or 20X speed. These discs can be played back in a CD-ROM drive or a CD player.</p> <hr/> <p><b>Notes</b></p> <ul style="list-style-type: none"> <li>• 16X- or 20X-speed writing is enabled with Partial CAV method. (→P. 6)</li> <li>• For 8X or faster writing, use CD-R discs that match their respective writing speeds.</li> </ul>
	<p><b>CD-RW discs</b><sup>*2</sup></p> <p>There are two types of CD-RW discs: those that support write/rewrite speeds of 1X, 2X, and 4X, and those that support only 2X. The <b>CRW2200</b> drive can write/rewrite at 2X or 4X speed on the first type of disc, and at 2X on the second type of disc. These discs can be read/played on a device (e.g., CD-ROM drive) that supports “CD-RW.”</p>
	<p><b>High Speed CD-RW discs</b><sup>*3</sup></p> <p>These discs allow writing/rewriting at 4X to 10X speeds. The <b>CRW2200</b> drive can write/rewrite these discs at 4X, 8X, or 10X speed. These discs can be read/played by a CD-RW drive that bears the High Speed CD-RW logo, or by a device (e.g., CD-ROM drive) that supports “CD-RW.”</p> <hr/> <p><b>Note</b></p> <p>10X-speed writing/rewriting is enabled with the CLV method, and the 4X-10X Full CAV method. (→P. 7)</p> <p></p> <ul style="list-style-type: none"> <li>• <b>In order to write, erase, or read these discs using a CD-R/RW drive, a drive bearing the High Speed CD-RW logo must be used. When using a CD-ROM drive to read these discs, the drive must be capable of reading CD-RW discs.</b></li> <li>• <b>If these discs are used in a CD-R/RW drive not bearing the High Speed CD-RW logo, the discs may not be recognized, resulting in the computer not operating correctly or other malfunctions occurring.</b></li> <li>• <b>Refer to the page at the URL below before attempting to read these discs on a Yamaha CD-R/RW drive not bearing the High Speed CD-RW logo.</b> URL: <a href="http://www.yamaha.co.jp/english/product/computer/">http://www.yamaha.co.jp/english/product/computer/</a></li> </ul>

\*1 Compatible with Orange Book Part 2.

\*2 Compatible with Orange Book Part 3 Vol. 1.

\*3 Compatible with Orange Book Part 3 Vol. 2.

### About the Orange Book

The Orange Book standard defines how all recordable discs (including CD-R and CD-RW) are written. Part 2 of the Orange Book standard relates to CD-R discs, and Part 3 to CD-RW discs. The standard was named after the color of the book's.

### About CD-ROMs

A CD-ROM disc is a compact disc containing high-density read-only data. It has many applications, including the playback of music and video, the archiving of data, as well as on-line documentation. The following are descriptions of each CD-ROM format:

CD-DA: Up to 79 minutes of stereo audio is written in 16-bit resolution at a sampling rate of 44.1kHz for a 79 minute disc.

Data CD: Up to 700 megabytes of computer data is stored in standard ISO9660 format for a 700MB disc.

Video CD: These hold movies in which the video and audio data has been compressed using MPEG-1 technology.

### About Partial CAV (Constant Angular Velocity)

Writing to a CD-R disc is normally done using the CLV (Constant Linear Velocity) method. In this method, the disc rotation speed will be so adjusted as to keep a constant data transfer rate at any portion of the disc. In other words, the disc rotation speed will vary in CLV writing.

In contrast, the CAV (Constant Angular Velocity) method uses a constant disc rotation speed for all portions of the disc so that the data transfer rate will vary. Because the CAV method has the advantage of largely increasing the data transfer rate with a minimum load to the drive's mechanism (compared to CLV's rotation speed adjustment), many current CD-ROM drives use the CAV method. CD formats define the constant linear density of written data (data should be written onto the disc track in the constant pitch) so that the amount of recorded data per disc rotation will increase as the writing point moves from the inner to the outer. In other words, in CAV writing the outer portion has an increased data transfer rate.

The **CRW2200** drive uses the CAV method in the inner portions as well as the CLV method in the outer portions (Partial CAV) in order to enable up to 20X-speed writing. The drive will control the disc rotation speed to start writing at 12X speed in the inner portions, gradually accelerating up to 20X speed and maintaining 20X speed in the outer portions.

**About 10X-speed writing/rewriting of a High Speed CD-RW disc**

10X-speed writing/rewriting of a High Speed CD-RW disc is enabled with the CLV method, and the 4X-10X Full CAV method. Commonly, writing/rewriting is enabled with the CLV method. When writing/rewriting with packet writing, you can also select the Full CAV method. For more details, refer to the documentation that came with your CD writing software. (Make sure that your CD writing software supports the Full CAV method. The included CD writing software is supported.) For direct editing of a file on a CD-RW disc, the Full CAV method is recommended.

## Serial Number

Once you have taken the **CRW2200** drive out of its packaging, you should immediately note down the serial number found at the top of the drive with the bar code. You may need to refer to this number when requesting Customer Support services. In the box below the following diagram, write down the 10-character serial number (consisting of 3 letters followed by 7 digits).

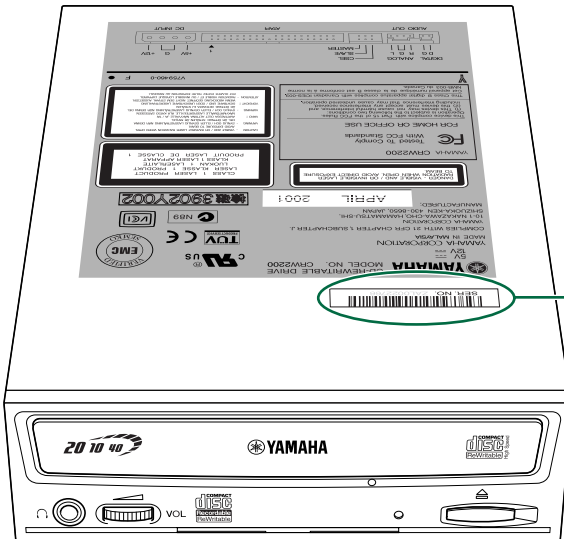

Serial number  
(3 letters and 7 digits)

Serial No.											
------------	--	--	--	--	--	--	--	--	--	--	--

# Front and Rear of Unit

## Front Panel

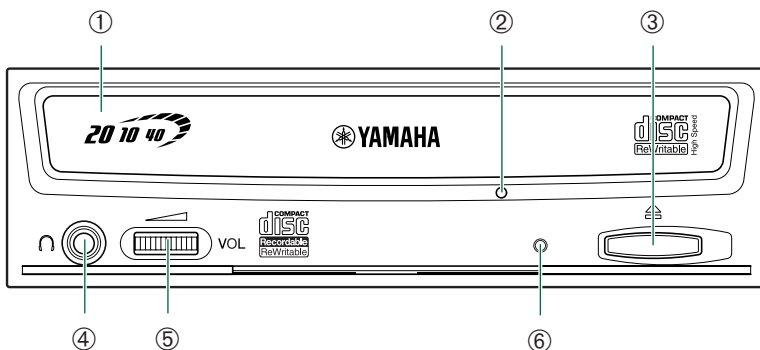

- ① **Disc tray**  
The tray is used to hold the disc. It slides out from the drive unit when a disc needs to be loaded or unloaded. (→P. 50)
- ② **Manual Eject hole**  
Only use this if no other method is available for unloading a disc. (→P. 51)
- ③ **Eject button**  
Press this button when you need to open or close the tray. Remove the disc after the tray has opened. (→P. 50)
- ④ **Headphone jack**  
You can connect stereo headphones to this stereo mini jack and listen to an audio CD loaded in the drive.
- ⑤ **Headphone volume control**  
Adjust this control to set a suitable volume level when listening to an audio CD using the headphone jack. Slide the knob to the left to decrease the volume and to the right to increase it.
- ⑥ **LED**  
Indicates the operation status of the **CRW2200** drive. (→P. 60)

## Rear Panel (with the SCSI Convertor)

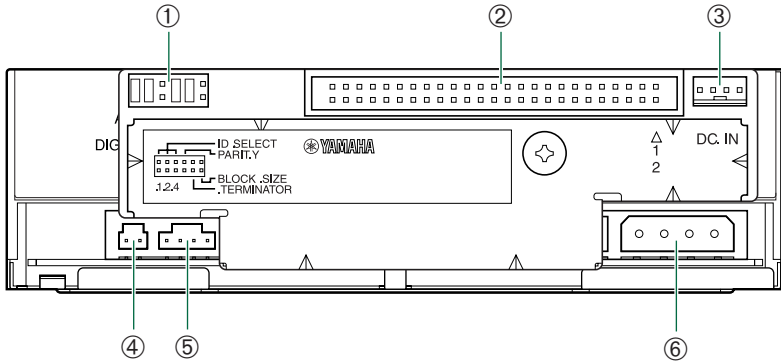

### ① Jumper switch

Plug a plastic shunt into this jumper switch to set up SCSI ID, Parity, Terminator and Block Size. (→P. 20 – 23)

### ② SCSI INTERFACE connector

Insert the connector of the SCSI ribbon cable here. (→P. 26, 33)

### ③ DC IN connector (The SCSI convertor's side)

Insert the smaller connector of the power cable (included). (→P. 19, 34)

### ④ DIGITAL AUDIO OUT connector

If your sound card has a SPDIF (digital audio) input connector, you can connect the DIGITAL AUDIO OUT connector of the unit to the SPDIF connector using a digital audio cable (sold separately). (→P. 17, 34)

### ⑤ ANALOG AUDIO OUT connector

Connect one end of the 4-pin audio cable to this connector, and the other end to your computer's sound card or built-in audio. (→P. 16, 34)

### ⑥ DC INPUT connector (The CRW2200 drive's side)

Insert the bigger connector of the power cable (included). (→P. 19, 34)

## Rear Panel (without the SCSI Converter)

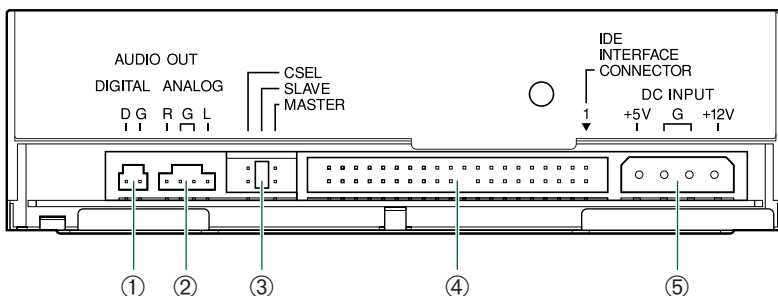

① **DIGITAL AUDIO OUT connector**

If your sound card has a SPDIF (digital audio) input connector, you can connect the DIGITAL AUDIO OUT connector of the unit to the SPDIF connector using a digital audio cable (sold separately). (→P. 17, 45)

② **ANALOG AUDIO OUT connector**

Connect one end of the 4-pin audio cable to this and the other end to your computer's sound card or built-in audio. (→P. 16, 44)

③ **Jumper switch**

Plug a plastic shunt into this jumper switch to select the connection, either IDE master or slave. The CRW2200 drive's factory setting is SLAVE. (→P. 42)

④ **IDE INTERFACE CONNECTOR**

Insert the connector of the IDE cable here. (→P. 43)

⑤ **DC INPUT connector**

Insert the power connector from your computer's power supply in this socket to feed power to the drive. (→P. 46)



# SCSI Connection Set Up

Make sure that the SCSI card to connect to the **CRW2200S** is installed beforehand. (→P. 4)

## Tools

### Phillips Screwdriver

---

You will need to use this when removing the cover of your computer and when mounting the drive. You may also need to temporarily remove the sound card to gain access to the CD audio connectors, in which case, a small screw retaining the sound card's face plate has to be removed.

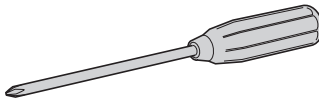

---

#### Note

Make sure your phillips screwdriver's head is the correct size for the screws you need to remove.

### Long-Nosed Pliers

---

You will need these to insert or remove the plastic shunts when setting the jumper switches at the rear of the **CRW2200S**.

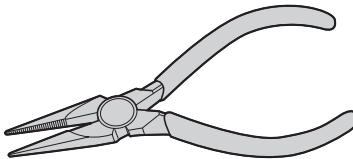

## CRW2200S Setup Flowchart

For easy cross-referencing, the relevant pages in this manual are given.

### STEP Connecting the CRW2200S

#### 1 (→P. 14 – 29)

1. Opening the Computer (→P. 14)
2. Audio cable connection (→P. 16)
3. Installing the SCSI Converter to the CRW2200 drive (→P. 18)
4. Setting the Jumper Switches (→P. 20)
5. Choosing the Connecting Method (→P. 24)
6. Installing the CRW2200S (→P. 25)



### STEP Configuring for the Operating System (→P. 30, 31)

#### 2

1. Check that the CRW2200S is recognized correctly. (→P. 30)
2. Enabling the Sync data transfer. (→P. 31)



### STEP Installing the CD Writing Software

#### 3

For details about how to install the software, refer to the documentation that came with it.



### STEP Start Using the CRW2200S!

#### 4

Use the drive to create audio CDs, to back up data on your hard disk, or for whatever purpose suits your needs.

## Connecting the CRW2200S

This section explains how to connect the **CRW2200S** by SCSI to a tower-type computer.

### Note

The way of removing the casing or panel, or installing built-in devices may differ from your computer. Be sure to follow the procedures in the documentation that came with your computer.

## Opening the Computer

### 1 Shut down your computer and unplug it from the AC outlet.



If you proceed without doing this, you run the risk of receiving an electric shock and/or short-circuiting and damaging components, including the **CRW2200S**.

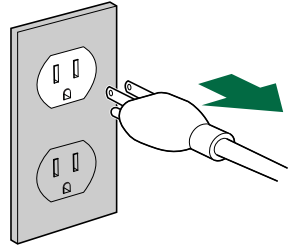

### 2 Remove all attached cables and peripheral devices and the outer casing of the computer. If you need to remove screws in the process, make sure you don't lose them. Remove the cover and front panel of the computer.

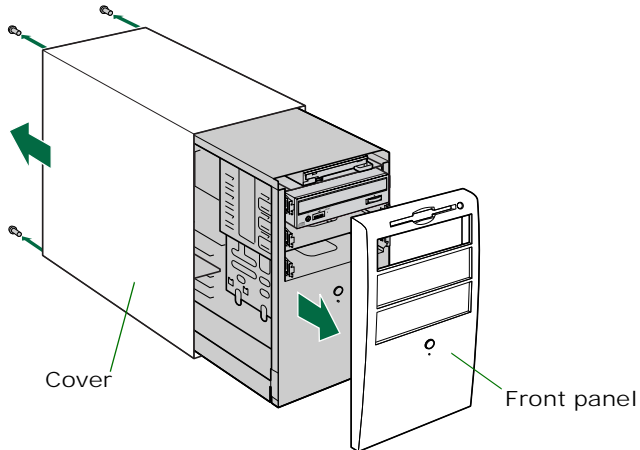

- 3 Touch a metal part of the computer's chassis or power supply unit to discharge any static electricity from your body. Or, wear an anti-static grounding wrist strap.**



You can permanently damage your equipment if you touch it with static electricity in your body.

Discharge any static charge

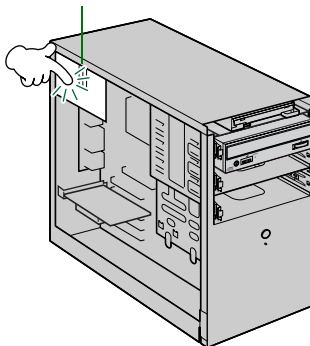

## Audio cable connection

Yamaha recommends connecting the audio cable before installing the SCSI convertor for easy connecting.

### 4 Connect the audio cable to the CRW2200 drive. (If necessary)

You can play audio CDs on the **CRW2200S** and hear it through your computer's sound card.

#### Notes on playing audio CDs

- Audio is available from the headphones or speakers connected to the headphone jack located on the front panel of the **CRW2200S** (this is convenient if you have no sound card in your computer). In this case, you do not need to connect an audio cable.
- When creating an audio CD, if you use the SCSI flat cable to send the signal, you do not need to connect an audio cable.
- If you use the **CRW2200S** as a supplemental drive for the unit, and the CD-ROM drive or DVD-ROM drive is already connected to the sound card, YAMAHA recommends you playback audio CDs using the existing drive.

There are two methods of connecting the unit and the sound card: an analog connection and a digital connection.

#### Connecting the analog audio cable

Connect one end (the end which has one connector) of the included audio cable to the ANALOG AUDIO OUT connector on the rear panel of the **CRW2200** drive. Make sure to check the connector direction according to the figure below.

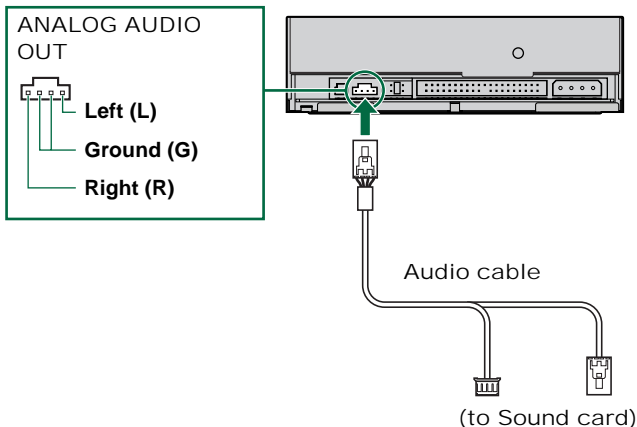

### Connecting the digital audio cable

The digital connection for the **CRW2200S** is ideal for pure quality audio playback, outputting digital signals recorded on CDs to the sound card without any distortion.

#### Examples of the digital connection

To output digital audio signals to external devices, you must use the digital connection to connect the unit and the sound card. With this connection you can:

- Enjoy music using a digital audio amplifier.
- Record music digitally with an MD player.

Connect the digital audio cable to the **DIGITAL AUDIO OUT** connector on the rear panel of the **CRW2200** drive, making sure of the connector's direction.

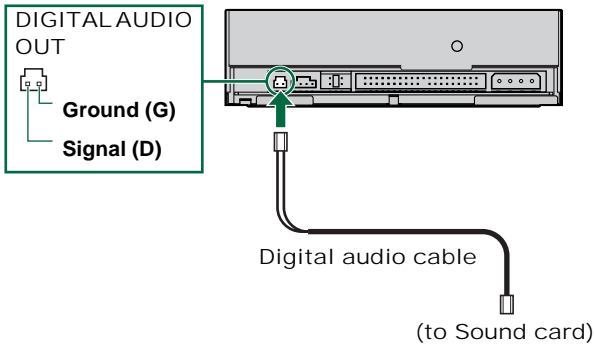

---

#### Note

For the digital connection, you need a digital audio cable with appropriate connectors, and a sound card with SPDIF (digital audio) input connectors.

## Installing the SCSI Converter to the CRW2200 drive

### Notes

- Do not touch the connector pins or the circuit board. Otherwise, it may cause a malfunction with the SCSI converter.
- Please follow the instructions below. Do not use excessive force when installing. Otherwise, it may cause damage.

### 5 Attach the SCSI converter (included) to the rear of the CRW2200 drive.

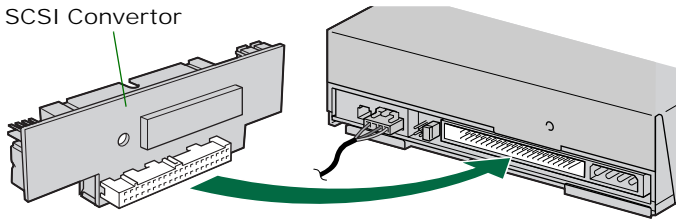

The jumper switch for the IDE settings on the rear panel of the CRW2200 drive can be set to any of MASTER/SLAVE/CSEL. This setting does not affect the CRW2200 drive operation. (→P. 42)

### 6 Secure the SCSI converter to the CRW2200 drive with the screw (included).

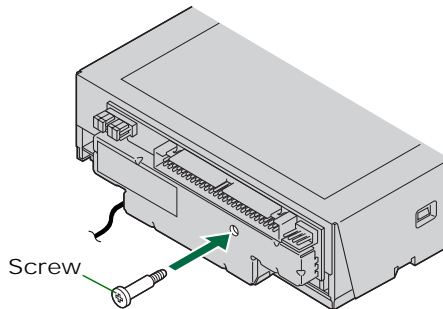

### Note

Do not apply excessive force when tightening the screw.

**7 Connect the forked end of the power cable (included) to the drive's and the SCSI convertor's DC INPUT connectors.**

Connect the smaller connector to the SCSI convertor with the yellow wire to the left. (See the figure below.)

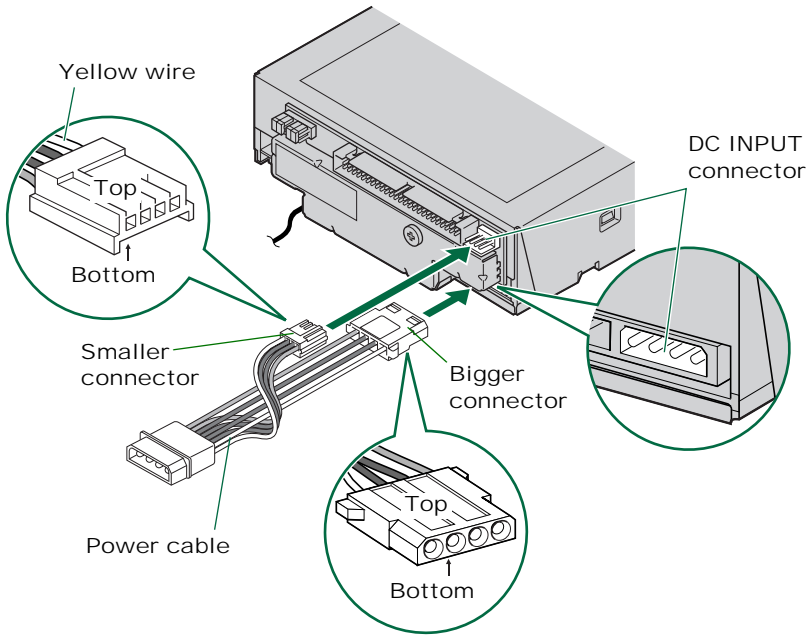

---

**Note**

These connectors are D-shaped, so you can only connect the power cables in the correct orientation. Do not apply excessive force when making this connection. You risk damaging the convertor if you make these connections upside down.



## Setting the Jumper Switches

**8** Before fitting the CRW2200S into the computer, you need to set up the drive using the jumper switches located at the rear of the unit. You'll need to set the following:

- ① SCSI ID number
- ② Parity check
- ③ Termination
- ④ Block size

To set each jumper switch, you have to bridge the two pins in the respective column of the grid with a plastic shunt. Shunts are already attached to the jumper switches in their default configurations.

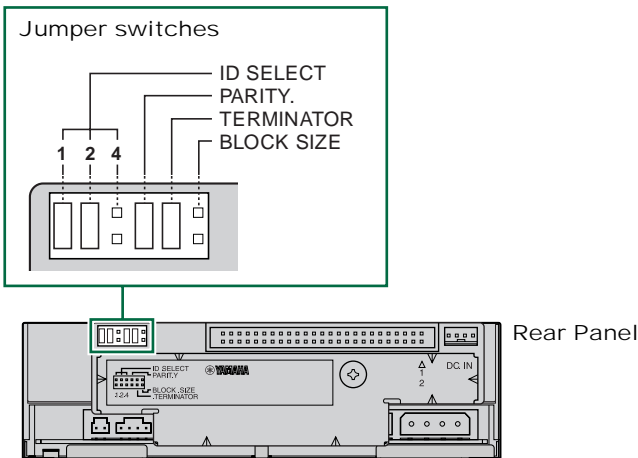

### Note

The plastic shunts actually contain metal for bridging the two pins of a jumper switch, creating an electrical connection between them when attached. When removed, the jumper switch is set to "OFF." Store unused shunts in a safe place where they will not be lost.



Use a pair of long-nosed pliers to attach or detach the plastic shunts accordingly. Make sure that the computer is turned off beforehand.

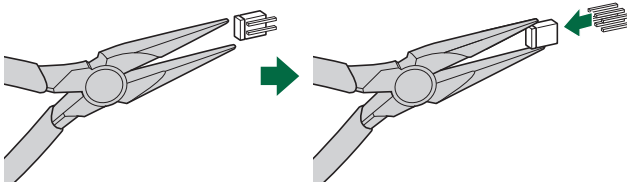

### ① SCSI ID Number

Each of the SCSI devices connected to the computer is identified by its SCSI ID number. You need to assign a number from “0” to “7” for each SCSI device. Commonly, ID number “7” is reserved for the computer’s SCSI card itself. Therefore, the **CRW2200S** can actually be assigned an ID number from “0” to “6.” The ID number is set by attaching/detaching the shunts on the ID Select jumper switches according to the diagram shown below.

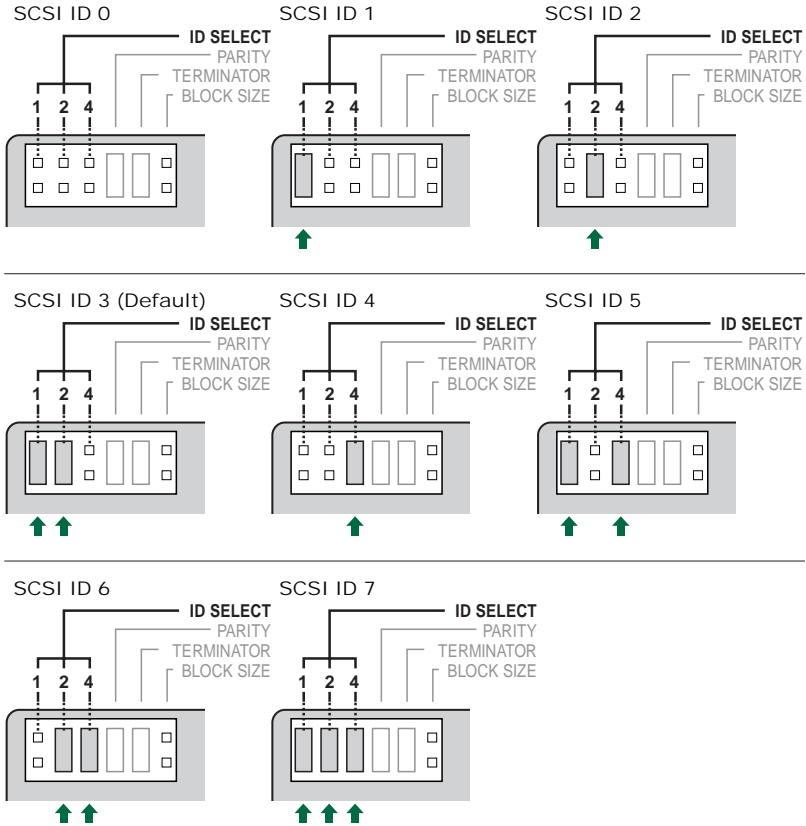

#### Note

The SCSI ID number for each device on the chain must be unique. Make sure the **CRW2200S**'s SCSI ID number is not the same as that of any other device on the chain. By factory default, the **CRW2200S** is assigned ID number “3” but this can be changed.

## ② Parity Check

The parity check is used for error correction during data transmissions. If parity-checking has to be disabled, the shunt on the Parity jumper switch should be removed.

**Parity ON (Default)**  
Normally leave this setting alone.

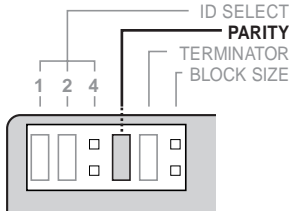

The setting allows for the parity checking. Normally, set PARITY to ON to enable error correction.

**Parity OFF**

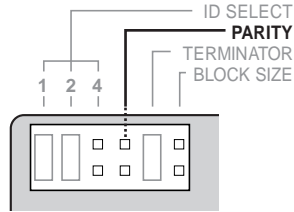

The setting does not allow for parity checking.

### Note

By factory default, the Parity switch is set to “ON” and should normally be left in this state.

## ③ Termination

Terminators prevent SCSI signals from being reflected off the last device in the chain. The SCSI terminator switch should be set to “ON” if the **CRW2200S** is the last device on the internal SCSI chain. If the **CRW2200S** is not the last device on the internal SCSI chain, the shunt on the Terminator jumper switch should be removed.

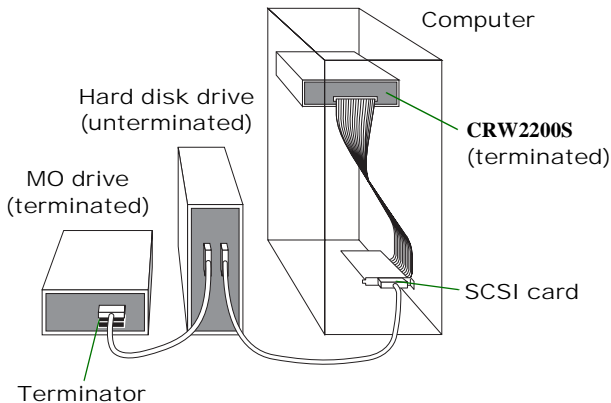

Termination ON (Default)

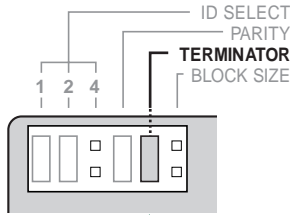

Set to "ON" if **CRW2200S** is last device on SCSI chain

Termination OFF

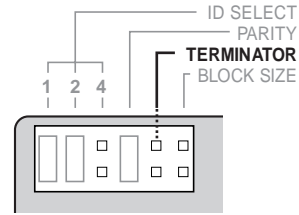

Set to "OFF" if the **CRW2200S** is not the last device on the SCSI chain

Note

The default setting of the Terminator switch is ON.

④ Block Size

The data block size of the **CRW2200S** can be set to 512 bytes per sector by setting the Block Size jumper switch to "ON." This is necessary when installing the **CRW2200S** on a UNIX-based workstation. It is not necessary for Windows 95/98/98 Second Edition/Me/NT4.0/2000 Professional computers.

About the Block Size

Block Size shows the capacity of a sector that is the unit of data management of OS.

Block size OFF (Default)

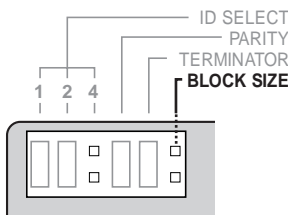

Block size ON

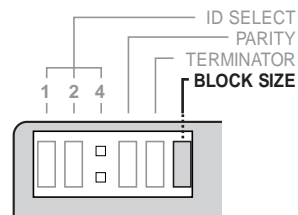

Set to "ON" when installing **CRW2200S** on UNIX workstation

Note

By factory default, the Block Size jumper switch is set to "OFF" and should normally be left in this state.

---

## Choosing the Connection Method

---

- 9** The CRW2200S can be used as an supplemental drive or as a replacement drive.

### As a supplemental drive

If the casing of your computer has a spare 5.25-inch drive bay available, such as with many tower-type computers, you can install the **CRW2200S** supplemental to the computer's existing CD-ROM drive.

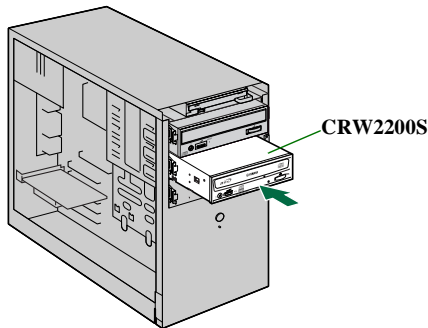

---

### As a replacement drive

If the casing of your computer does not have a spare 5.25-inch drive bay available, such as with many desktop-type computers, you can replace the computer's existing CD-ROM drive with the **CRW2200S**.

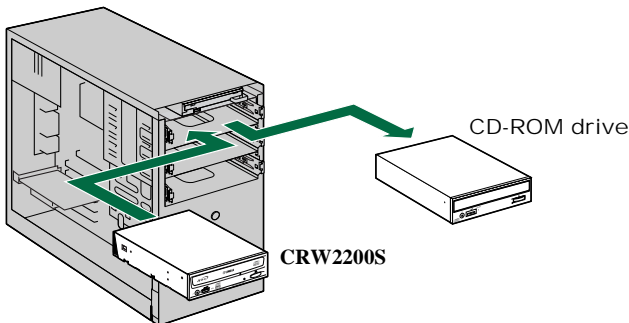

---

### Note

You cannot replace the computer's existing CD-ROM drive with the **CRW2200S** using the existing cable if the drive is a IDE type. In this case, use an 50-pin SCSI flat cable to connect the **CRW2200S**.

## Installing the CRW2200S

---

### 10 As a supplemental drive

Remove the front cover of a vacant 5.25-inch drive bay slot.

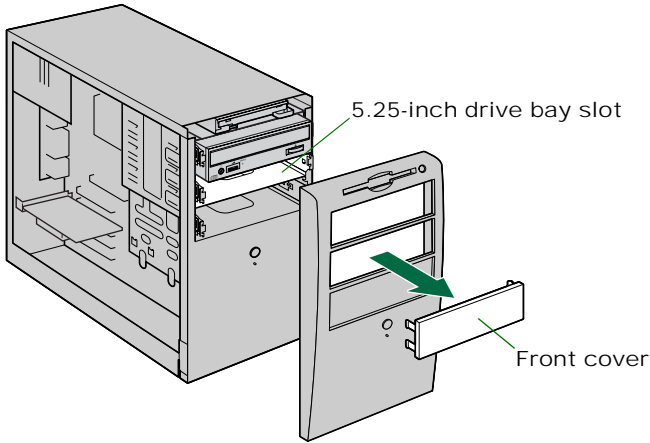

---

#### Note

To remove the front cover, refer to the documentation that came with your computer.

---

### As a replacement drive

Disconnect all the cables connected to the rear of the existing CD-ROM drive, and also disconnect the audio cable from the sound card or motherboard's audio connector. Remove the CD-ROM of your computer.

(In the illustration below, the devices show, are all IDE type. The procedure for SCSI type installation is the same.)

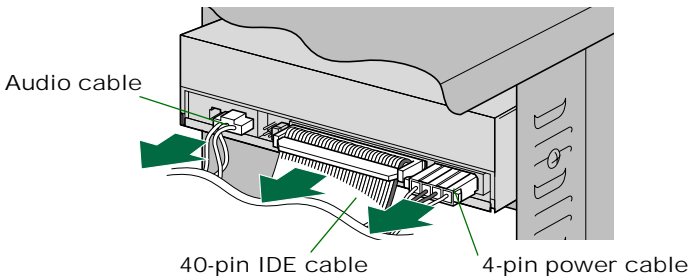

---

#### Notes

- Care should be taken not to damage cables connected to the rear of the CD-ROM drive.
- The Audio connecting cable is equipped with a locking mechanism to secure it in place. To release the lock, lift up the connector and gently pull it out.
- Do not apply excessive force to the CD-ROM drive.
- If the removed device is an IDE type and set to MASTER, the other device that is on the same cable should be changed from SLAVE to MASTER. (→P. 39 – 41)

The following explains how to add the drive to the computer as illustrated. If you are replacing the existing CD-ROM drive, the procedure is basically the same.

**Note**

The way of installing built-in devices may differ, depending on the computer. Refer also to the documentation that came with your computer.

- 11 Slide the drive backwards into the slot, then tighten the four fastening screws on the sides of the unit to hold the drive in place.**

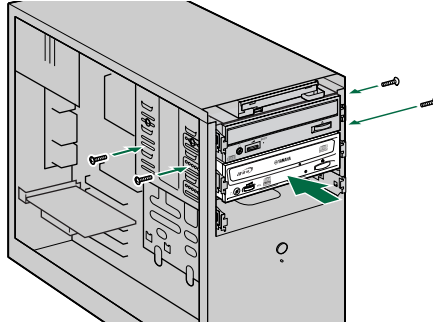

**Notes**

- Do not apply excessive force when sliding the drive backwards into the drive bay slot.
- Leave enough room behind the drive to connect the power, SCSI, and audio cables.

- 12 Connect one end of the 50-pin SCSI flat cable to the computer's SCSI card. Align the colored line of the cable with Pin 1 of the card's SCSI connector. Next, connect a free 50-pin connector on the SCSI flat cable to the back of the CRW2200S such that the colored line on the cable is aligned with pin 1, marked "SCSI INTERFACE CONNECTOR 1."**

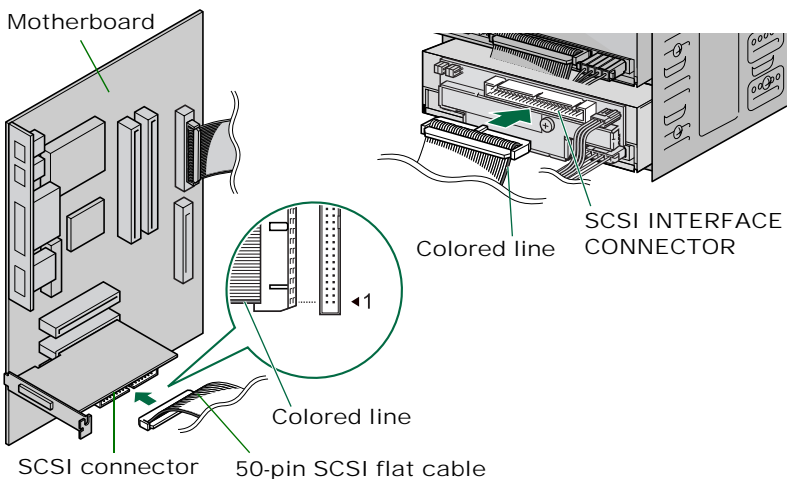

### 13 Connect the audio cable to the sound card.

#### Connecting the analog audio cable

There are two connectors at the sound card side of the cable: a vertically-mounted type (PH) and a horizontally-mounted type (MPC). Choose the one that matches your sound card's connector and leave the other free.

**Note**

Some sound cards may have one or more audio input connectors. However, depending on your connectors, the specifications may differ from the **CRW2200** drive. If no sound is audible from the speaker even though the audio cable is connected, refer to the documentation that came with your sound card for more details, and make sure that your audio cable is connected correctly.

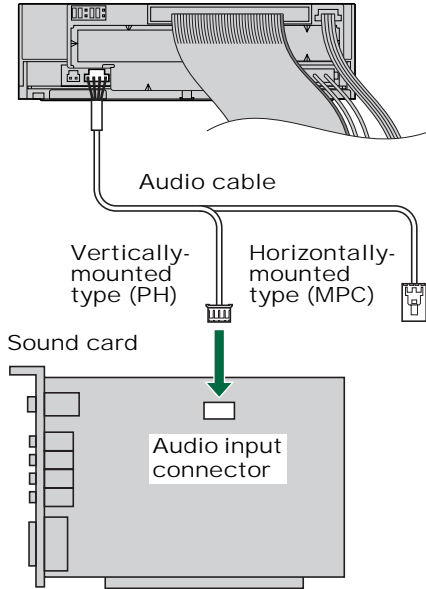

#### Connecting the digital audio cable

Connect the digital audio cable to the SPDIF input connector (digital audio) of the sound card, making sure of check of the connector's direction.

**Note**

For the digital connection, you need a digital audio cable with appropriate connectors, and a sound card with SPDIF (digital audio) input connectors.

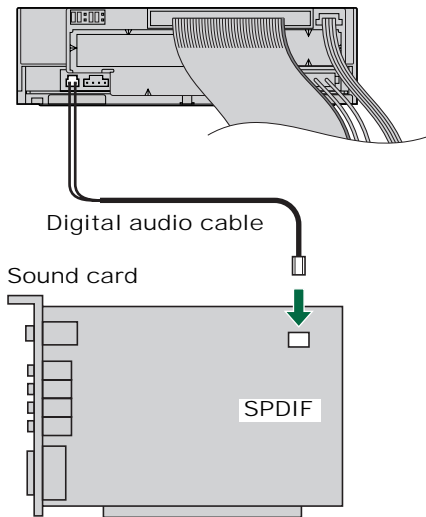

**Note**

When removing the drive from the PC, disconnect the sound card's side of the cable first. After removing the SCSI convertor, disconnect the drive's side of the cable.



**14 Connect the 4-pin power cable from the computer's power supply to the power cable from the CRW2200S.**

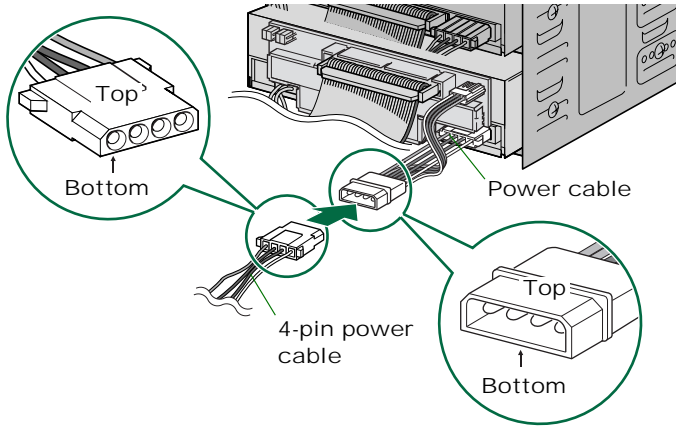

**Notes**

- There may be more than one 4-pin power cable available. Any one may be used.
- These connectors are D-shaped, so you can only connect the power cables in the correct orientation. Do not apply excessive force when making this connection.

**15 Tighten the four fastening screws on the side of the unit securely using a phillips screwdriver.**

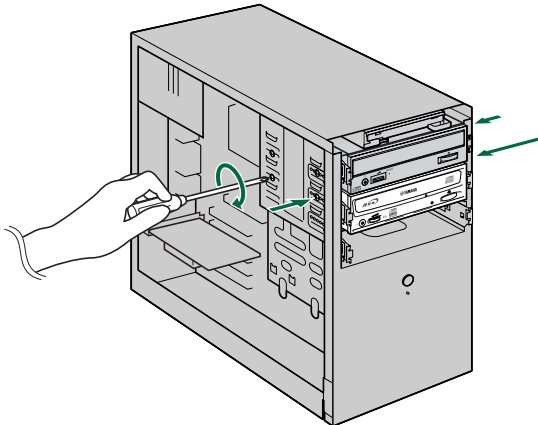

**16 Attach the outer casing and all cables and peripheral devices of the computer and any screws that were removed.**

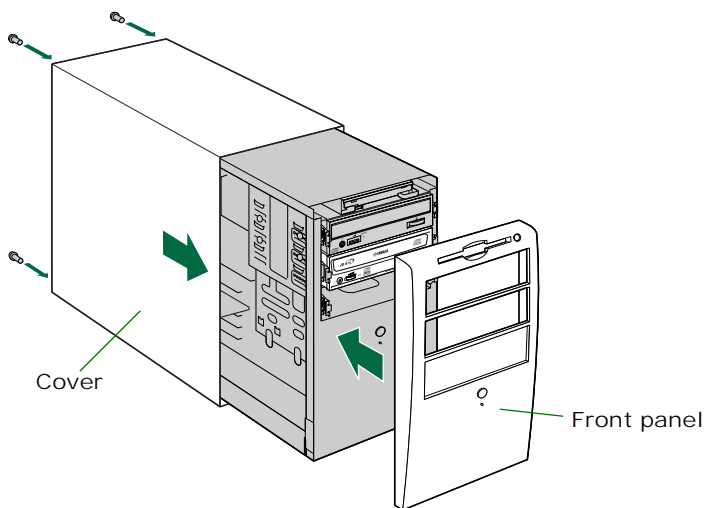

**17 Reconnect the computer to the AC outlet and turn it on.**

When you turn on the computer, make sure the LED on the panel of the **CRW2200S** blinks in green, which indicates that it is reading disc information. (→P. 60)

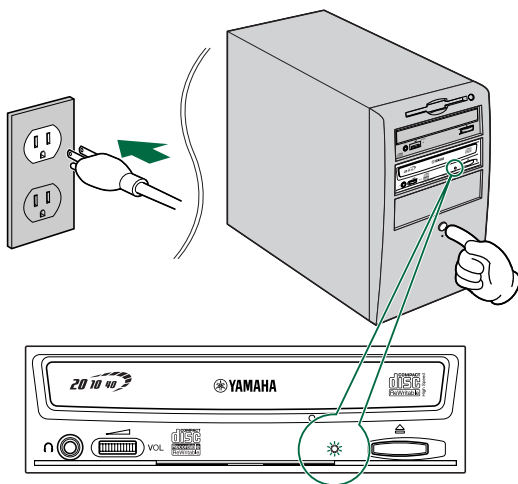

## Configuring for the Operating System

- 18** After the computer's operating system (Windows 95/98/98 Second Edition/Me) has loaded, open "Control Panel" and double-click on the "System" icon. Select the "Device Manager" tab and double-click on "CDROM." If the drive has been correctly installed, it should be listed as shown below. Similarly, double-click on "SCSI controllers" and the SCSI card should be listed as shown below if it has been properly installed.

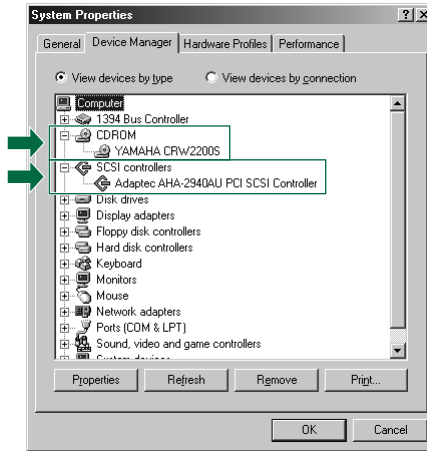

*\* This is a screen shown in the Windows Me environment.*

### For Windows NT

You can verify by opening "Control Panel," double-clicking on "SCSI Adapter" and clicking on the "Devices" tab.

### For Windows 2000 Professional

You can verify by opening "Control Panel," double-clicking on "System," selecting the "Hardware" tab, and clicking on the "Device Manager" button in "System Properties."

### Notes

- For details about how to use the operating system, refer to the documentation that came with it.
- If there is a **✘** or **!** mark etc. next to the icon for the **CRW2200S** or the SCSI card, this means that it has not been installed correctly.

**19** Double-click on “YAMAHA CRW2200S” listed under “CDROM” (in Windows 95/98/98 Second Edition/Me) and click on the “Settings” tab. Check the “Sync data transfer” checkbox. With “Sync data transfer” enabled, the data transfer between your CRW2200S drive and your computer is synchronized, meaning that the maximum possible data transfer rate can be achieved.

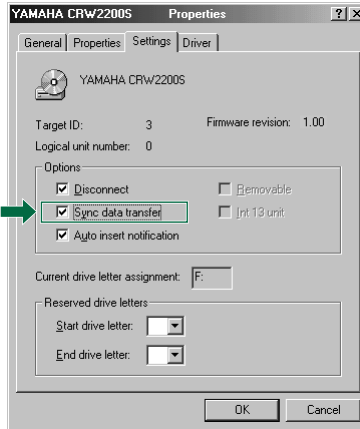

*\* This is a screen shown in the Windows Me environment.*

---

### Notes

- For details, refer to the documentation that came with your SCSI card.
- When using Windows NT/2000 Professional, “Sync data transfer” will automatically be selected if the SCSI card supports this feature. You will not need to change this setting.

---

## Installing the CD Writing Software

**20** Install the CD writing software.

For details about how to install the software, refer to the documentation that came with it.

# Removing the SCSI convertor

## Tools

### Phillips Screwdriver

You will need to use this when removing the cover of your computer and when removing the SCSI convertor from the drive. You may also need to temporarily remove the sound card to gain access to the CD audio connectors, in which case, a small screw retaining the sound card's face plate has to be removed.

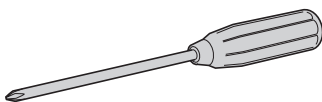

#### Note

Make sure your phillips screwdriver's head is the correct size for the screws you need to remove.

## Removing the SCSI convertor

#### Notes

- The way of removing the casing or panel may differ from your computer. Be sure to follow the procedures in the documentation that came with your computer.
- Do not touch the connector pins or the circuit board. Otherwise, it may cause a malfunction with the SCSI convertor.
- Please follow the instructions below. Do not use excessive force when installing. Otherwise, it may cause damage.

- 1 Shut down your computer and unplug it from the AC outlet.**  
(→P. 14 step 1)
- 2 Remove all attached cables and peripheral devices and the outer casing of the computer. If you need to remove screws in the process, make sure you don't lose them. Remove the cover and front panel of the computer.**  
(→P. 14 step 2)
- 3 Touch a metal part of the computer's chassis or power supply unit to discharge any static electricity from your body. Or, wear an anti-static grounding wrist strap.**  
(→P. 15 step 3)

**4 Disconnect all cables connected to the CRW2200S and remove it from the computer.**

If the audio cable is connected to the **CRW2200S**, disconnect the sound card's side connector only.

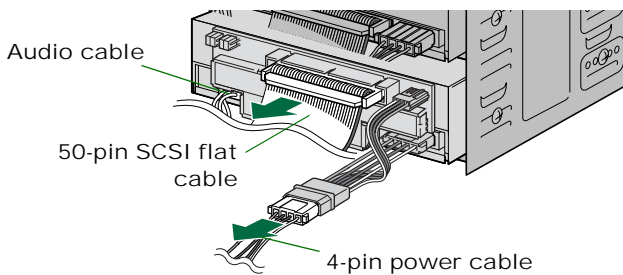

**5 Remove the screw securing the SCSI convertor to the CRW2200 drive.**

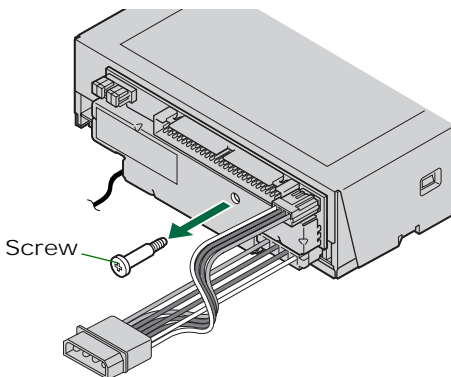

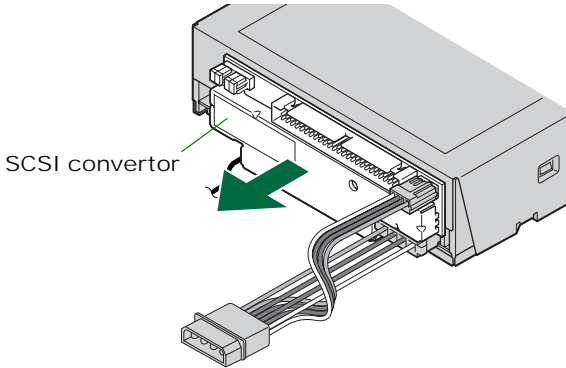
**6 Remove the SCSI converter from the CRW2200 drive.****7 Disconnect the power cable from the SCSI converter and the CRW2200 drive.**

The smaller connector connected to the SCSI converter is locked with its hook. Lift up the connector to unlock the hook, then pull it out. (See the figure below.) If the audio cable is connected, disconnect it after removing the converter. (An analog audio cable connection is shown in the figure below.)

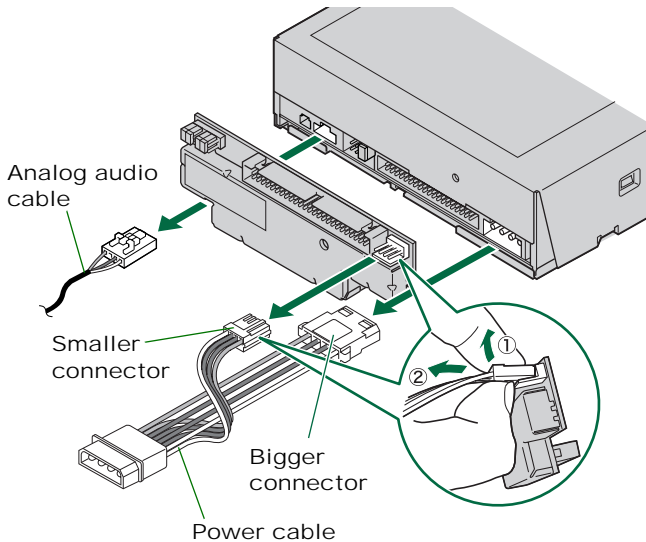



# E-IDE (ATAPI) Connection Set Up

If the **CRW2200S** has already been installed to the computer by SCSI connection, remove it from the computer and detach the SCSI convertor. (→P. 32 – 34)

## Tools

### Phillips Screwdriver

You will need to use this when removing the cover of your computer and when mounting the drive. You may also need to temporarily remove the sound card to gain access to the CD audio connectors, in which case, a small screw retaining the sound card's face plate has to be removed.

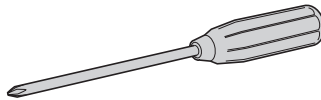

#### Note

Make sure your phillips screwdriver's head is the correct size for the screws you need to remove.

### Long-Nosed Pliers

You will need these to insert or remove the plastic shunts when setting the jumper switches at the back of the **CRW2200** drive.

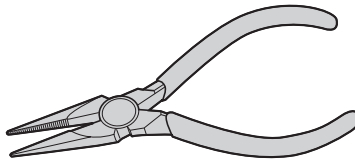



## CRW2200E Setup Flowchart

For easy cross-referencing, the relevant pages in this manual are given.

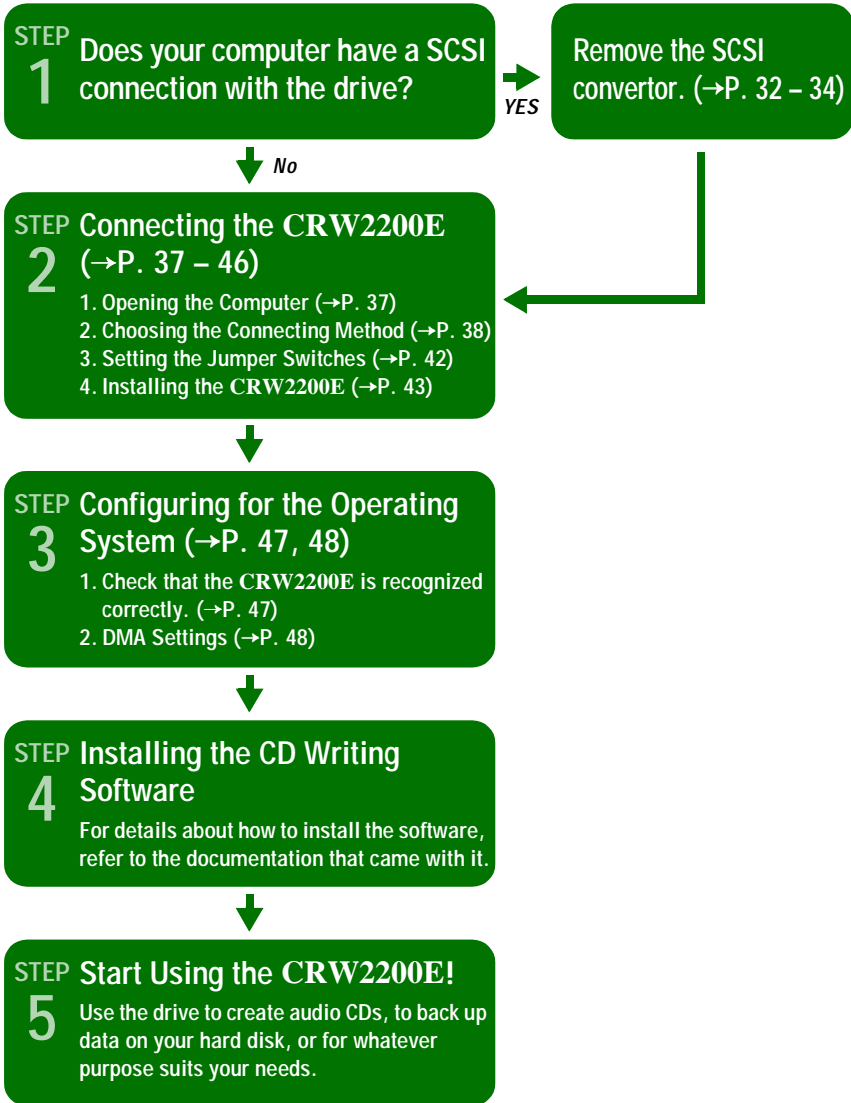

## Connecting the CRW2200E

This section describes how to connect the **CRW2200E** by E-IDE (ATAPI) to a tower type computer.

In this description, about some parts that is duplicated with the part of “Connecting the CRW2200S” in “SCSI Connection Set Up” (→P. 14 – 31), see the reference page described here.

---

### Note

The way of removing the casing or panel, or installing built-in devices may differ from your computer. Be sure to follow the procedures in the documentation that came with your computer.

---

## Opening the Computer

- 1 Shut down your computer and unplug it from the AC outlet.**  
(→P. 14 step 1)
- 2 Remove all attached cables and peripheral devices and the outer casing of the computer. If you need to remove screws in the process, make sure you don't lose them. Remove the cover and front panel of the computer.**  
(→P. 14 step 2)
- 3 Touch a metal part of the computer's chassis or power supply unit to discharge any static electricity from your body. Or, wear an anti-static grounding wrist strap.**  
(→P. 15 step 3)

---

## Choosing the Connection Method

---

- 4 First, check how existing IDE devices are connected to your computer, and then determine how to connect the CRW2200E in conjunction with those devices.**

### As a supplemental drive

If the casing of your computer has a spare 5.25-inch drive bay available, such as with many tower-type designs, you can install the **CRW2200E** supplemental to the computer's existing CD-ROM drive.

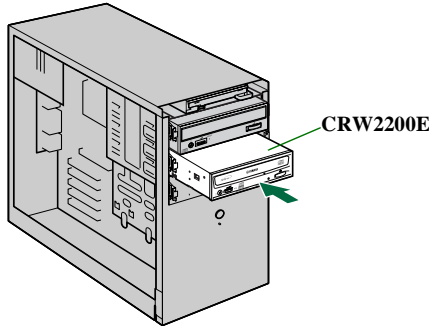

---

### As a replacement drive

If the casing of your computer does not have a spare 5.25-inch drive bay available, such as with many desktop-type designs, you can replace the computer's existing CD-ROM drive with the **CRW2200E**.

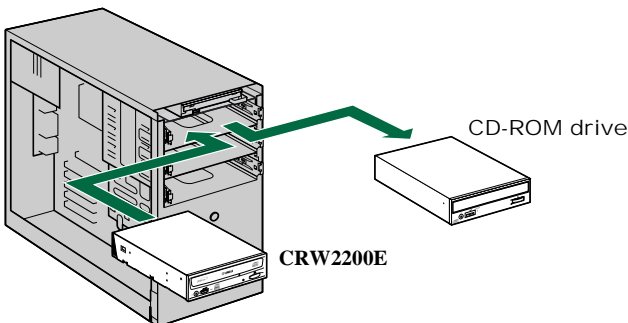

---

#### Note

You cannot replace the computer's existing CD-ROM drive with the **CRW2200E** using the existing cable if the drive is a SCSI type. In this case, use an IDE cable to connect the **CRW2200E**.

### About IDE

IDE (Enhanced IDE/E-IDE) is one of the standards applied to the connection between personal computers and their peripherals. A computer motherboard provides two IDE connectors (primary and secondary). (Although, some motherboards provide only a primary connector.) You may connect up to two IDE devices (hard disk, CD-ROM, or CD-R drives) to the connectors using an IDE cable. One of the devices connected via the IDE cable is called “master” and the other is called “slave.”

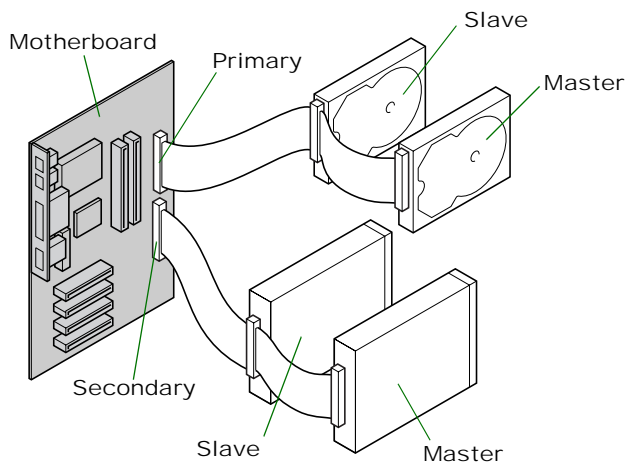

### Notes

- When you are using the IDE device as a master, connect the device to the connector of the leading edge of the IDE cable, or you are using the device as a slave, connect the device to the connector of the middle of the IDE cable.
- When you connect two IDE devices to one IDE cable, assign each as MASTER or SLAVE respectively. The **CRW2200E** is shipped with the SLAVE setting.

### Typical IDE-type hardware installation

When replacing an existing IDE-type drive to another Controller Port, you will need to change the device settings (MASTER/SLAVE).

### Note

For details on settings, refer to the documentation that came with the device or the manufacturer's Home Page.

### Connecting examples

Yamaha recommends one of the following connections.

#### **Example-1: As secondary slave (For supplemental drive)**

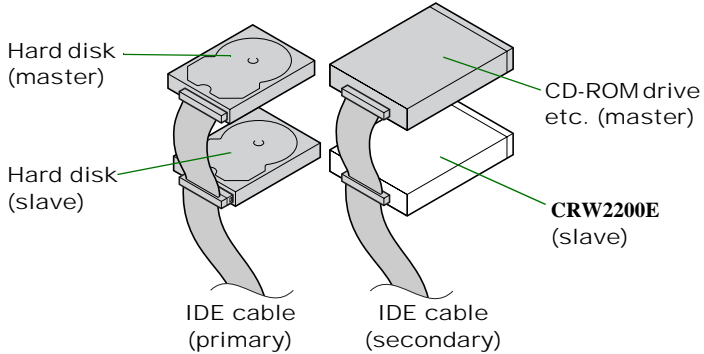

#### **Example-2: As secondary master (For replacing your existing drive with the unit)**

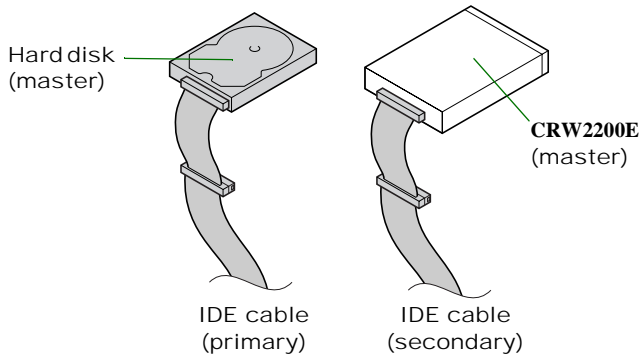

**To make the best use of the performance of the CRW2200E, Yamaha recommends you connect it as a sole secondary master.**

#### **Note**

The **CRW2200E** is shipped with the SLAVE setting. Reset to MASTER if you connect the drive solely to the secondary IDE cable.

### Notes

- When replacing an IDE-type hardware solely to a IDE cable, select master for the drive, and connect it at the end of the cable.
- When the operating system starts with the SCSI hard drive, a primary IDE connector may have no IDE devices. In such a case, Yamaha recommends you connect the **CRW2200E** as a primary master.
- When you connect the removed IDE-type hardware to the other connector of the cable, some cables may have only one connector. In such a case, use the cable with two connectors.

## Setting the Jumper Switches

- 5 Set the CRW2200E as MASTER or SLAVE to meet your computer environment by plugging the included plastic shunt into the appropriate jumper switch on the rear panel of the CRW2200E.

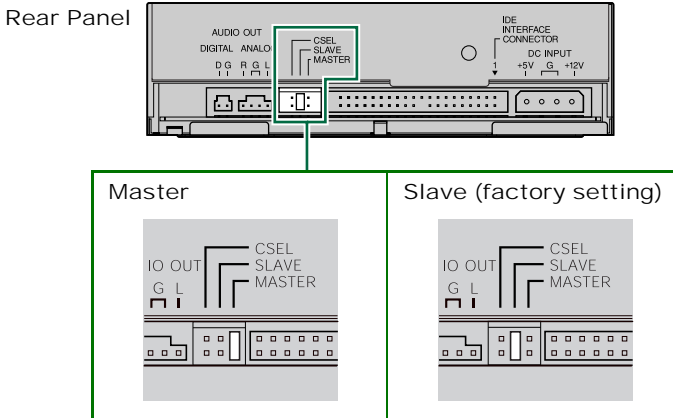

**The CRW2200E is shipped with the SLAVE setting. Thus, you do not need to reset the factory setting if you plan to use the CRW2200E as SLAVE. If you connect the drive solely to the secondary IDE cable or replace the drive with an existing master device, you need to reset the CRW2200E as MASTER.**

### Note

The plastic shunts actually contain metal for bridging the two pins of a jumper switch, creating an electrical connection between them when attached. When removed, the jumper switch is set to "OFF." Store unused plastic shunts in a safe place where they will not be lost.

### About the CSEL jumper switch

If your computer supports the CSEL function, you can plug a plastic shunt into this jumper switch to have the computer automatically select MASTER or SLAVE for the CRW2200E. However, we recommend using the MASTER or SLAVE jumper switch because the CSEL function sometimes creates a conflict. Refer to the documentation that came with your computer to check whether the computer supports the CSEL function.



Use a pair of long-nosed pliers to attach or detach the plastic shunts accordingly. However, make sure that the computer is powered down when doing so.

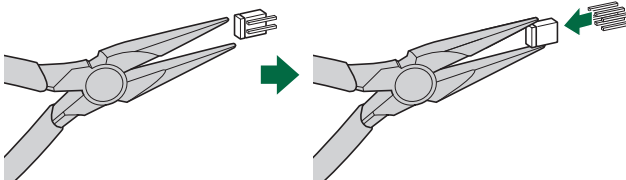

## Installing the CRW2200E

### 6 As an supplemental drive:

Remove the front cover of a vacant 5.25-inch drive bay slot of the computer in case of using the **CRW2200E**. (→P. 25 step 10)

### As a replacement drive:

Remove the device such as CD-ROM from the computer for **CRW2200E**. (→P. 25 step 10)

### 7 Slide the drive backwards into the slot, then tighten the four fastening screws on the sides of the unit to hold the drive in place. (→P. 26 step 11)

### 8 Connect the IDE cable.

Connect the 40-pin IDE cable to the IDE connector on the motherboard and to the IDE interface connector on the rear panel of the **CRW2200E**. Be sure to plug in the cable so that the colored line on the cable corresponds to pin 1 on the right end of the connector. The pin 1 of the IDE connector is labeled on the motherboard, or refer to the documentation that came with your computer.

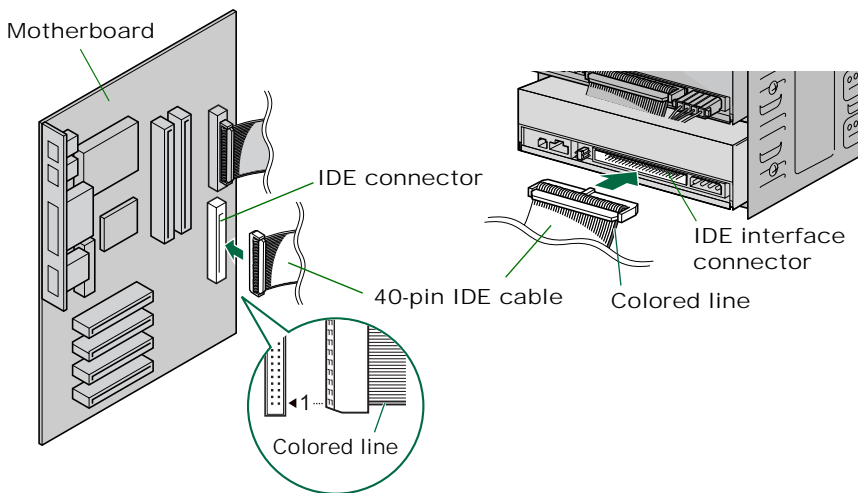

### Notes

- The included IDE cable supports the UltraDMA/33 mode, and does not support the UltraDMA/66 mode and the UltraDMA/100 mode. Please note that the IDE devices connected to the included IDE cable cannot be operated with the UltraDMA/66 mode and the UltraDMA/100 mode.
- Using with a UltraDMA/66 mode compatible IDE cable, the **CRW2200E** is supported.
- When connecting by a commercial IDE cable or a IDE cable included with your computer, use the length of cable 18 in. (45.7 cm) or less.
- When you connect two IDE devices to one IDE cable, be sure to assign each as MASTER or SLAVE respectively.



## 9 Connect the audio cable. (If necessary)

You can play audio CDs on the **CRW2200E** and listen through your computer's sound card.

### Notes

- Audio is available from the headphones or speakers connected to the headphone jack located on the front panel of the **CRW2200E** (this is convenient if you have no sound card in your computer). In this case, you do not need to connect an audio cable.
- When creating an audio CD, if you use the IDE cable to send the signal, you do not need to connect an audio cable.
- If you use the **CRW2200E** as a supplemental drive for the unit, and the CD-ROM drive or DVD-ROM drive is already connected to the sound card, YAMAHA recommends you playback audio CDs using the existing drive.

There are two methods of connecting the unit and the sound card: an analog connection and a digital connection.

### Connecting the analog audio cable

Connect one end (the end which has one connector) of the included audio cable to the ANALOG AUDIO OUT connector on the rear panel of the **CRW2200E**.

Make sure to check the connector direction according to the figure below.

There are two connectors at the opposite end of the audio cable: a vertically-mounted type (PH) and a horizontally-mounted type (MPC). Choose the one that matches your soundcard's connector and leave the other free.

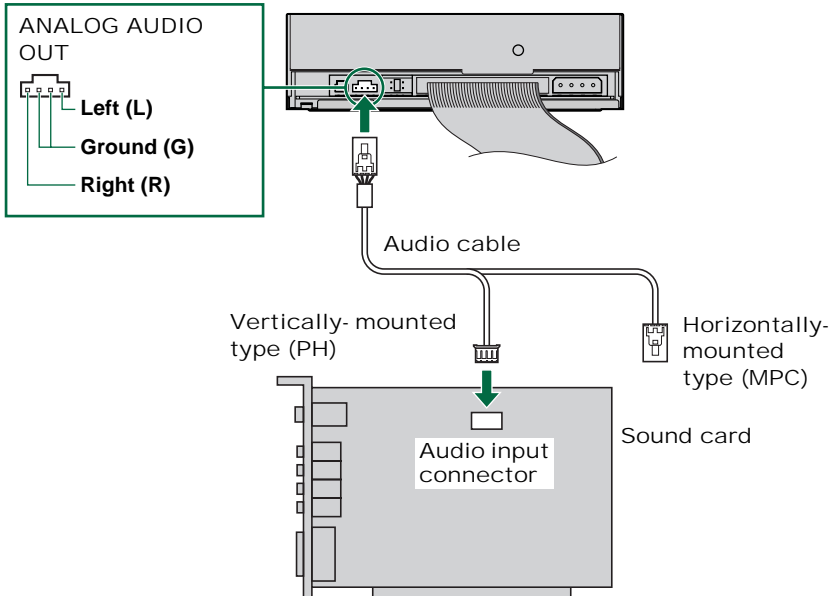

### Note

Some sound cards may have one or more audio input connectors.

However, depending on your connectors, the specifications may differ from the **CRW2200E**. If no sound is audible from the speaker even though the audio cable is connected, refer to the documentation that came with your sound card for more details, and make sure that your audio cable is connected correctly.

The ANALOG AUDIO OUT connector of the **CRW2200E** is shown in the figure on the previous page.

### Connecting the digital audio cable

The digital connection for the **CRW2200E** is ideal for pure quality audio playback, outputting digital signals recorded on CDs to the sound card without any distortion.

---

#### Examples of the digital connection

To output digital audio signals to external devices, you must use the digital connection to connect the unit and the sound card. With this connection you can:

- Enjoy music using a digital audio amplifier.
- Record music digitally with an MD player.

Use the digital audio cable to connect the DIGITAL AUDIO OUT connector of the unit and the SPDIF input connector (digital audio) of the sound card, making sure of the connector's direction.

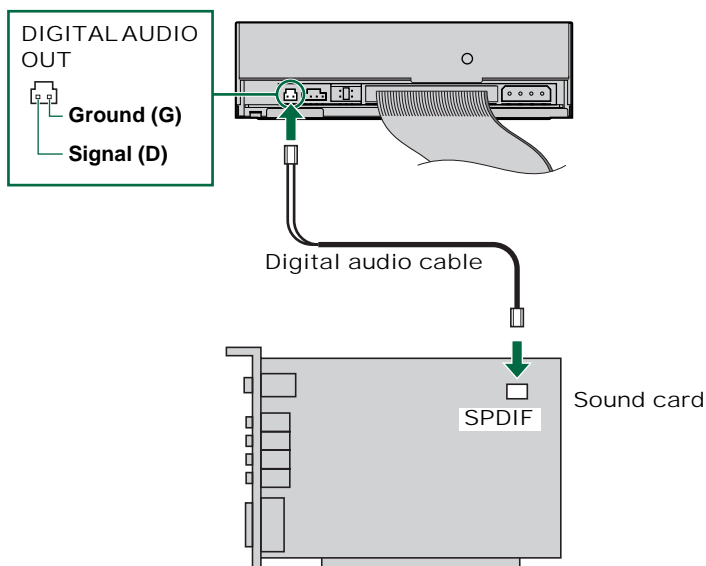

---

### Note

For the digital connection, you need a digital audio cable with appropriate connectors, and a sound card with SPDIF (digital audio) input connectors.

The DIGITAL AUDIO OUT connector of the **CRW2200E** is shown in the figure above.

**10 Connect a 4-pin power cable to the power supply connector of the CRW2200E marked “DC INPUT.”**

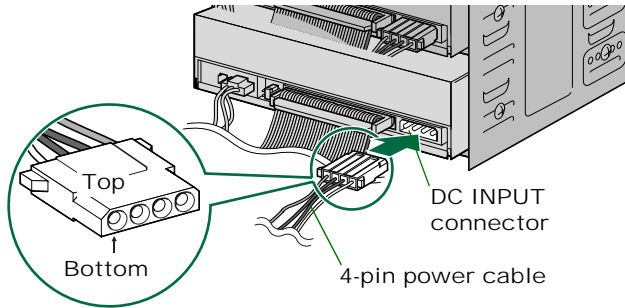

**Notes**

- There may be more than one 4-pin power cable available. Any one may be used.
- These connectors are D-shaped, so you can only connect the power cables in the correct orientation. Do not apply excessive force when making this connection.

**11 Tighten the four fastening screws on the side of the unit securely using a phillips screwdriver. (→P. 28 step 15)**

**12 Attach the outer casing and all cables and peripheral devices of the computer and any screws that were removed. (→P. 29 step 16)**

**13 Reconnect the computer to the AC outlet and turn it on. (→P. 29 step 17)**

When you turn on the computer, make sure the LED on the panel of the CRW2200E blinks in green, which indicates that it is reading disc information. (→P. 60)

## Configuring for the Operating System

---

- 14** When using Windows 95/98/98 Second Edition/Me, after the computer's operating system has loaded, open "Control Panel" and double-click on the "System" icon. Select the "Device Manager" tab and double-click on "CDROM." If the drive has been correctly installed, it should be listed as shown in the figure below.

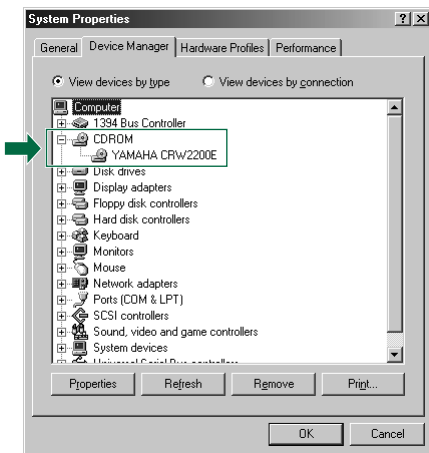

*\* This is a screen shown in the Windows Me environment.*

---

### For Windows NT

You can verify by opening "Control Panel," double-clicking on "SCSI Adapter" and clicking on the "Devices" tab.

---

### For Windows 2000 Professional

You can verify by opening "Control Panel," double-clicking on "System," selecting the "Hardware" tab, and clicking on the "Device Manager" button in "System Properties."

---

### Notes

- For details about how to use the operating system, refer to the documentation that came with it.
- If there is an **X** or **!** mark, etc., next to the icon for the **CRW2200E**, this means that it has not been installed correctly.

- 15 When using Windows 95/98/98 Second Edition/Me, follow Step 14 to open the “Device Manager” window, then double-click on the “YAMAHA CRW2200E” icon to open the “YAMAHA CRW2200E Properties” window, and click on the “Settings” tab to select it. A screen similar to the one below appears. Make sure that the “Sync data transfer” check box is not checked. (There is no need to set the “Sync data transfer” check box if it does not appear.) By checking the “DMA” check box, you can enable high-speed data transfer between the CRW2200 drive and the computer. However, depending on your computer system, this may cause operations to become unstable. If this occurs, uncheck “DMA.”

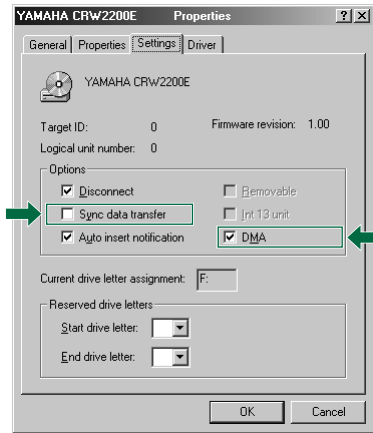

\* This is a screen shown in the Windows Me environment.

### About DMA Settings (Setting of Transfer Mode)

OS	Recommended Setting	Details
Windows 95/98/98 Second Edition/Me	ON	Unstable Operation, set OFF
Windows NT4.0	—	No setting
Windows 2000 Professional	DMA mode	Unstable Operation, set PIO mode

#### Notes

- Windows NT does not have the “DMA” setting. Nor do you need to set the “Sync data transfer” parameter, since it will not appear.
- For Windows 2000 Professional  
To set the “DMA,” log on as an Administrator. Open the “Device Manager” window, and double-click on “IDE ATA/ATAPI controllers,” then double-click on the IDE Channel icon connected to your unit. On the displayed window, click on the “Advanced Settings” tab, and choose “Transfer Mode” to select it.
- Enabling or disabling the “Sync data transfer” option does not affect the **CRW2200E**.

**About DMA**

DMA (Direct Memory Access) is a method that transfers data between various peripheral devices (e.g., a hard drive, CD-R/RW drive, etc.) and the computer's memory without using the CPU. By checking the "DMA" check box, the transmission speed of data will become high-speed. Furthermore, by decreasing the CPU load, the processing speed of the computer systems is increased.

## **Installing the CD Writing Software**

---

**16 Install the CD writing software.**

For details about how to install the software, refer to the documentation that came with it.

# Operation

You can load and eject a disc (as described below) only when the computer is turned on.

## Loading a Disc

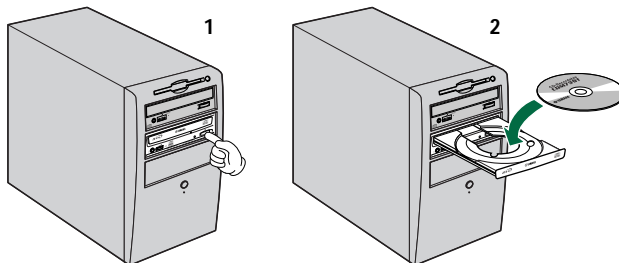

- 1** Open the tray by pressing the Eject button on the CRW200 drive's front panel.
- 2** Place the disc onto the tray with its label or printing facing upward.
- 3** Close the disc tray by pressing the Eject button again. You can also gently push it closed.



Load or unload the disc after the tray has fully opened. Do not push or pull the tray using excessive force. Doing so can damage the drive or the disc.

## Ejecting a Disc

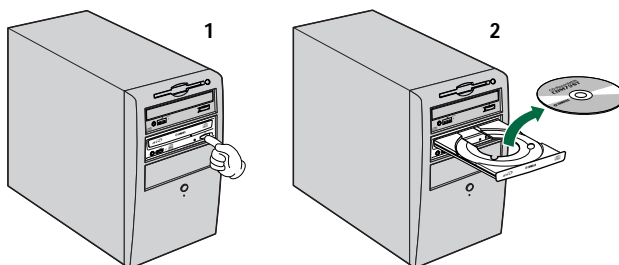

- 1** Open the tray by pressing the Eject button on the CRW200 drive's front panel.
- 2** Remove the disc from the tray.
- 3** Close the disc tray by pressing the Eject button again. You can also gently push it closed.

### Notes

- The disc tray will not open if the computer is not turned on. With the **CRW2200** drive turned on, pressing the Eject button will not open the disc tray if ATAPI commands prohibit ejecting a disc, such as during data reading.
- Remove the disc only after the disc tray has opened fully. Otherwise, you risk damaging the drive or the disc.

## Ejecting a Disc in an Emergency

If the disc tray fails to open for some reason, such as a malfunction of the internal spring-loaded mechanism or power outage, it can be opened manually.

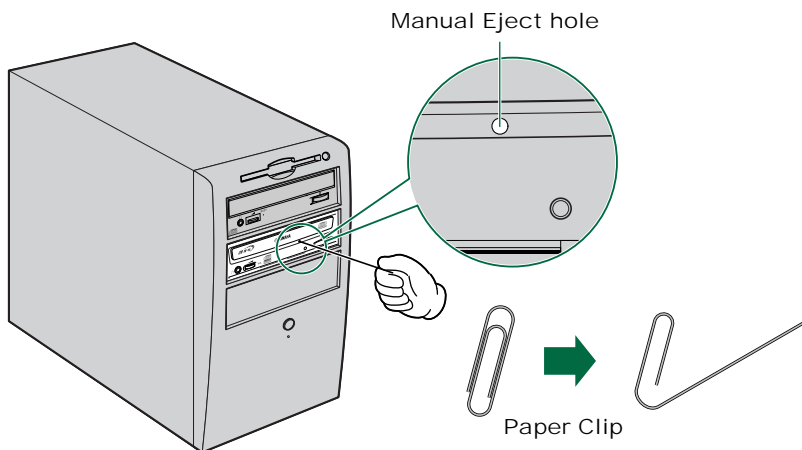

You should attempt to eject a disc manually only as a last resort. Malfunctions may occur if you do this too frequently.

- 1 Shut down the computer.**
- 2 Find a pin-like tool with a diameter of 2mm or less to fit through the Manual Eject hole on the drive's front panel.**

---

### Note

A straightened large paper clip is ideal for this purpose.

- 3 Push the tool gently into the Manual Eject hole until the spring-loaded mechanism ejects the tray and disc.**
- 4 Turn on your computer to close the disc tray.**



# Troubleshooting

Please refer also to the YAMAHA CD-R/RW Drive's web site for more information.

## **YAMAHA CD-R/RW Drives web site URL:**

<http://www.yamaha.co.jp/english/product/computer/>

## **Europe:**

<http://www.yamaha-it.de/>

## **The drive does not turn on. (When the LED on the front panel of the CRW2200 drive does not light up.)**

---

- For SCSI connection  
Are the three connectors (connected to the drive, the convertor, and the power supply) all connected correctly?  
Power down your computer and remove the outer casing, then make sure that the connectors of the drive or the SCSI convertor are connected in the correct direction, and the 4-pin power cable connectors are attached tight.  
(→P. 14, 19, 28)
- For an E-IDE (ATAPI) connection  
Is the 4-pin power cable from the computer's power supply attached correctly?  
Power down your computer and remove the outer casing, then make sure that the connectors of the 4-pin power cable are securely connected in the correct direction. (→P. 37, 46)

## **The computer does not start up.**

---

- Is the SCSI card installed correctly? Please read the instructions that came with your SCSI card for details.

## **The CRW2200S is not recognized. (In the case of SCSI connection)**

---

- Is the 4-pin power cable from the computer's power supply attached correctly, and does the drive turn on? Also, is the SCSI cable connected correctly?  
If the system has started up normally, you will be able to see the **CRW2200S** and SCSI card listed in **Control Panel | System | Device Manager** tab. The drive will be listed when you double-click on **CDROM** and the SCSI card will be listed when you double-click on **SCSI controllers**. (→P. 30)  
When you turn on your computer, you can access the machine's hardware SCSI BIOS settings before Windows is loaded. You can set your computer to recognize the SCSI card and **CRW2200S** in the BIOS.

---

### **Note**

Generally, the BIOS (Basic Input / Output System) is a small program that resides on a ROM chip on the computer's motherboard as well as on some expansion cards. It checks the system and its devices (such as serial ports and hard disk controllers) before loading the operating system (OS).

- Are you using the correct SCSI driver (mini-port driver)?  
If the SCSI card has not been installed correctly under Windows 95/98/98 Second Edition/Me/NT/2000 Professional, make sure that you have installed the most recent SCSI driver supplied by the SCSI card manufacturer.  
For information about the latest version of driver, please contact the respective SCSI card manufacturer.
- Is the SCSI card recognized correctly by the operating system (OS)?  
The SCSI driver for your SCSI card may be incorrect. For more details, contact the SCSI card manufacturer.
- Is the drive's SCSI ID number the same as that of another device on the SCSI chain? (→P. 21)
- Are the pins and holes on the SCSI connectors straight and not deformed?  
Check the connectors. (→P. 26)
- Is the terminator of the last device on the SCSI chain set to "ON?" Or if it has no built-in termination, has a terminator been attached? (→P. 22)
- Is the terminator on the **CRW2200S** set correctly?  
It should be set to ON only if it is the last device on the SCSI chain. Otherwise, it should be set to OFF. (→P. 22)
- Is the termination on the SCSI card set such that internal SCSI devices can be connected?  
Please read the instructions that came with your SCSI card for details.
- Check other SCSI devices to eliminate the possibility of troubles.  
If you use more than one SCSI device simultaneously, it may cause a trouble on your device drivers, or data transfer speed for some reason.  
Disconnect other SCSI devices from the computer but leave the **CRW2200S** connected, and be sure that your unit is recognized correctly.
- To write to CD-R/RW discs, your CD writing software must support the **CRW2200S**.  
To find out if it does, contact the manufacturer of your CD writing software.

### **The CRW2200E is not recognized. (In the case of E-IDE (ATAPI) connection)**

---

- Is the 4-pin power cable from the computer's power supply attached correctly, and does the drive turn on? Also, is the IDE cable connected correctly?  
If the system has started up normally, you will be able to see the **CRW2200E** listed in **Control Panel | System | Device Manager tab**. The drive will be listed when you double-click on **CDROM**. (→P. 47)
- When you turn on the computer, make sure that the drive name, **CRW2200E**, appears while Windows is starting up. If the name does not appear, check the cable connections for the **CRW2200E**.

- Check to see if there are any problems with other IDE devices.  
Some problems may occur in a multiple-IDE device system due to incompatibilities between the IDE devices and the computer, device drivers, data transfer speed, or other reasons. Make sure that the **CRW2200E** is recognized by the computer by temporarily removing other IDE devices from the system.
- Are the pins and holes on the IDE connectors straight and not deformed? Check the connectors. (→P. 43)
- Are your IDE devices connected correctly?  
If only one device is connected to one IDE cable, check that the setting of the device is MASTER or CSEL. When you connect two IDE devices to one IDE cable, be sure to assign each as MASTER or SLAVE respectively. If the setting of the **CRW2200E** is CSEL, change the setting to MASTER or SLAVE. (→P. 42)
- Is the **CRW2200** drive connected to a high-speed device, such as a hard disk drive?  
If you connect two devices with quite different speeds using the same cable, operation may become unstable.
- To write to CD-R/RW discs, your CD writing software must support the **CRW2200E**.  
To find out if it does, contact the manufacturer of your CD writing software.

---

#### The disc tray does not open.

- Is the **CRW2200** drive turned on?  
The LED on the front panel of the **CRW2200** drive lights up.
- Some CD writing software will lock the disc tray once loaded.  
In this case, use the eject command from within the software. Refer also to the documentation that came with the software.
- Disconnect the SCSI or IDE cable from the **CRW2200** drive. Turn on the computer, and press the eject button.

---

#### The disc keeps being ejected.

- Has the disc been placed on the disc tray correctly?

---

#### The drive does not operate correctly.

- Is the disc compatible with the **CRW2200** drive? (→P. 60)  
Blank discs cannot be played.
- Is there dust on the disc tray or on the disc itself?
- Does the computer have a sufficient power supply?  
The **CRW2200** drive's power consumption is 12W with a SCSI connection and 11W with a ATAPI connection (when reading and writing).
- Does your computer have several different CD writing software applications installed?  
If you use two or more CD writing software application simultaneously, the behavior of the drive may become unpredictable.

## No sound of CD-DA (audio CD) disc is audible.

- If no sound is audible from the speakers, etc., connected to your computer, make sure that your audio cable is connected correctly between the sound card and your computer. (→P. 16, 17, 27, 44, 45)
- For users with Windows Me, if no sound is audible from your headphones connected to the headphone jack on the front panel of the **CRW2200** drive, or from speakers connected to the ANALOG AUDIO OUT connector on the rear panel of the **CRW2200** drive through a sound card, make settings as shown below. (When you are using the Windows Media Player 7.0 with Windows Me, above symptom is known to exist because the initial setting default to ON for the “Digital playback.”)

### Note

The following procedures are described for a SCSI connection. For the connection of the E-IDE (ATAPI) models, please give the **CRW2200E** name to the **CRW2200S**.

### 1 The “Properties” setting of the CRW2200S.

- ① Open the “YAMAHA CRW2200S Properties” window and click on the “Properties” tab.
- ② Uncheck the “Enable digital CD audio for this CD-ROM device.” check box.

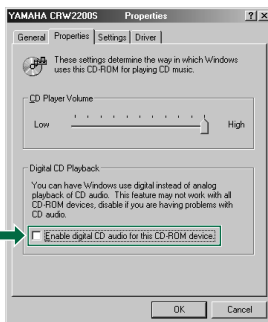

### 2 The setting of the Windows Media Player.

- ① Start “Windows Media Player.”
- ② Click “Tools” on the Menu and click on “Options” to open the “Options” window, then click on the “CD Audio” tab.
- ③ Uncheck the “Digital playback” check box.

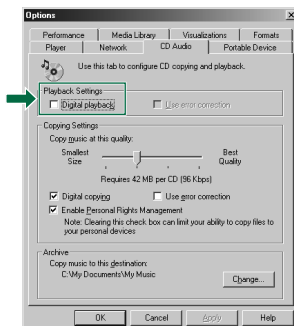

---

The drive ejects or fails to read the disc, or the front panel LED remains lit in orange after the disc has been loaded (meaning that the disc has not been recognized). (→P. 60)

---

- Disconnect the SCSI or IDE cable from the drive but leave the power cable connected, then load a disc.
- There may be problems with the disc itself. If the drive fails to recognize a variety of discs including audio CDs, CD-ROMs, and blank CD-R/RW discs (the front panel LED remains lit in orange after a disc is inserted), you should contact your nearest Yamaha dealer.

The “Buffer Underrun” error message is displayed.

---

- If your CD writing software supports the Buffer Underrun Protection, you must activate the Buffer Underrun Protection. For more details, refer to the documentation that came with your CD writing software.
- For more effective writing, and to avoid causing “Buffer Underrun,” try the following:
  - Lower the writing speed setting.
  - Create an image file of the CD on the computer’s hard disk.
  - Optimize the hard drive (Defragment the drive).
  - When writing, close other applications (including screen savers, etc.).
  - Turn hard disk power management off.
  - Select “Sync data transfer” for the setting of transfer mode of the SCSI devices such as a hard drive or a CD-ROM drive, etc. (→P. 31)  
For IDE devices, select “DMA” for the setting of transfer mode. (→P. 48)
  - Deactivate the Active Desktop (if you are using Internet Explorer 4 or later).
  - Close residential software.
  - Make sure any trouble does not stem from your CD writing software by referring to the documentation that came with it.

---

**Note**

Errors can occur if you knock or move the **CRW2200** drive while it is writing to disc.

---

**Other problems**

---

- Do you have several kinds of CD writing software applications installed in the same system?  
Some CD writing software applications may conflict if installed together, resulting in unstable operations.

## Writing Modes

### Disc-at-Once (DAO)

This mode is used when writing a complete disc in a single pass without pausing. Data cannot be added later, even if the full capacity of the blank disc has not been used.

Example: General CD-ROM

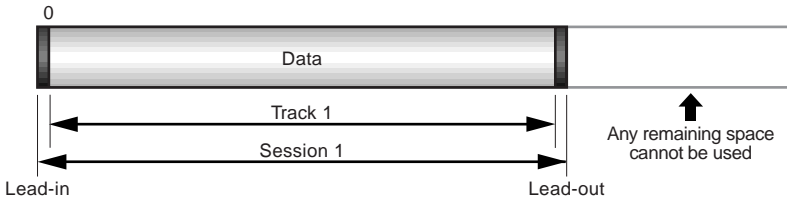

Example: Audio CD

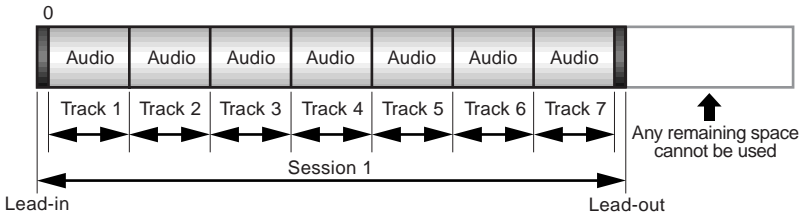

#### Note

The lead-in and lead-out areas signify the beginning and end points of a session. They are not part of the data but contain information about the session itself. Basically, a session consists of a lead-in, data, and a lead-out.

### Track-at-Once (TAO)

This mode is used when writing data to a disc one track at a time. More tracks can be added later if there is enough space left on the disc. This is why Track-at-Once mode is sometimes referred to as Multisession.

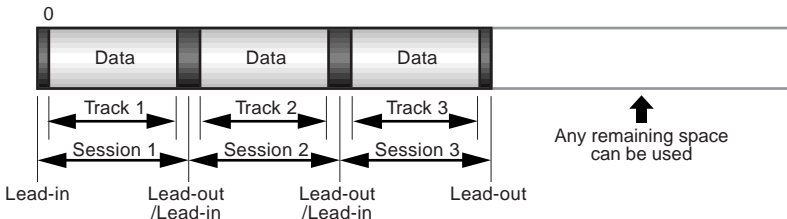

#### Note

Only the first session of a multisession disc can be played back on a conventional audio CD player. Single session discs can be played back completely.

## Session-at-Once (SAO)

As a writing method that combines the advantages of the above-mentioned “Disc-at-Once” and “Track-at-Once,” you can combine multiple tracks into one session and write them, and then add additional data.

For example, this is the writing method used to create a CD EXTRA format CD. The music tracks will be recorded in the first session, and the data will be recorded in the second session.

Example: CD EXTRA

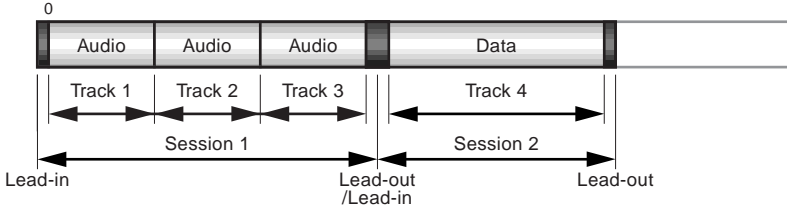

## Packet Writing

This mode is used when writing to a track of a disc using small blocks of data called “packets,” in a manner similar to a floppy disk. This mode is useful when making small incremental backups of data. You will need to use software that specifically supports packet writing, such as Adaptec’s Direct CD.

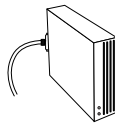

Same as writing to floppy or hard disk

### Notes on Packet Writing

- Discs must be formatted before they can be used for packet writing. With CD-RW, erased data can be overwritten until the disc is completely full.
- When using packet writing on a CD-RW disc, the actual data capacity is 100MB less than that stated on the cover of the disc. The difference in capacity is dependent on the writing mode.
- With CD-R, the space used by the erased data cannot be reused and is “masked” so that it is no longer visible. This can be done up to 100 times.

## About firmware

Firmware is a small piece of software built into the **CRW2200** drive, and is used to operate the drive. Since it resides in flash memory, it can be overwritten and updated. To ensure more reliable operations and enhanced performance of the drive, updates to the firmware will be made available. You can find information about the most recent firmware for the drive on YAMAHA CD-R/RW Drive's web site.

### URL for YAMAHA CD-R/RW Drives web sites:

<http://www.yamaha.co.jp/english/product/computer/>

### Europe:

<http://www.yamaha-it.de/>

The most recent user support information, including firmware updates, can be found in the YAMAHA CD-R/RW Drive's web site. Please check this information regularly.

## Determining the firmware version of the CRW2200 drive (in Windows 95/98/98 Second Edition/Me)

Go to **Control Panel | System | Device Manager** tab, double-click on **CDROM**, then double-click on **YAMAHA CRW2200S**.

### Note

The following procedures are described for a SCSI connection. For the connection of the E-IDE (ATAPI) models, please give the **CRW2200E** name to the **CRW2200S**.

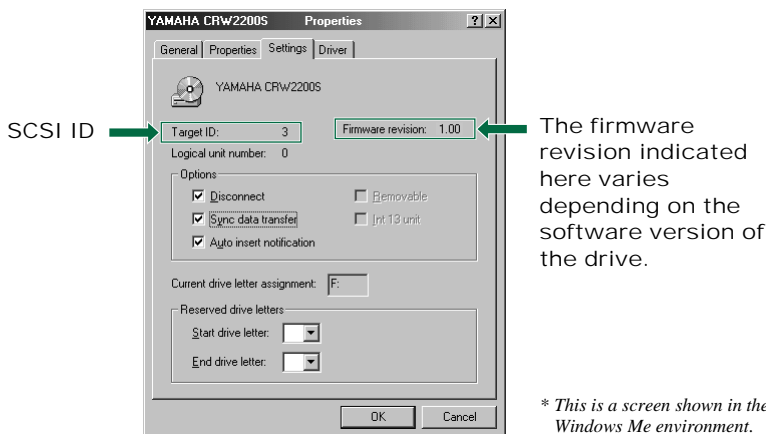

*\* This is a screen shown in the Windows Me environment.*

### For Windows NT

You can verify by opening "Control Panel," double-clicking on "SCSI Adapter" and clicking on the "Devices" tab. Then right-click on "YAMAHA CRW2200S" and select "Properties."

### For Windows 2000 Professional

If you open the "Device Manager" window, the firmware version will not be displayed. Use your CD writing software to check the firmware version.



## LED Indicator Messages

The **CRW2200** drive properly installed inside the computer will indicate the following LED messages while the drive (and the computer) are turned on.

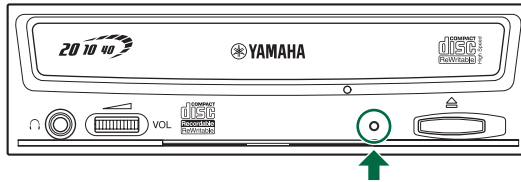

Status	Indicator Messages	LED Color
Ready (with disc)	Lit	Green
Ready (no disc)	Lit	Orange
Tray operation (opening/closing)	Blinking (constant)	Green
Tray fully opened	Out	—
Reading disc information (TOC)	Blinking (constant)	Green
Initial access in writing	Blinking (constant)	Orange
Writing (test mode)	Blinking (constant)	Orange
Writing	Blinking fast (constant)	Orange
Reading	Flashing (inconstant)	Green
Playing	Blinking fast (constant)	Green
Power saving (combined with the computer's power saving)	Out	—
Failure	Flashing (inconstant)	Orange

## CRW2200 Specifications

### Supported Formats

	Write	Read	Play
CD-DA	●	●	● (*4)
CD TEXT	●	●	●
CD-ROM (*1)	●	●	●
Mixed Mode CD-ROM (CD-ROM+CD-DA)	●	●	● (*4)
CD-ROM XA (*1)	●	●	● (*4)
Photo CD (*1)	● (*2)(*3)	●	● (*4)
Video CD	●	●	● (*4)
CD-i	●	● (*3)	● (*4)
CD EXTRA (*1)	●	●	● (*4)

\*1: includes multisession

\*2: suitable disc required

\*3: suitable application software required

\*4: suitable application software required for playback

### Note

Excludes ADPCM Encode/Decode & Video Encode/Decode functions.

## Appendix

---

Writing Methods	Disc-at-Once (DAO) Session-at-Once (SAO) Track-at-Once (TAO) Packet Writing	
Writing/Reading Speed	Writing	<p>CD-R 1X, 2X, 4X, 8X, 12X (CLV), 16X (12X – 16X Partial CAV) 20X (12X – 20X Partial CAV)</p> <p>CD-RW 2X, 4X, 8X, 10X (CLV) 4X – 10X Full CAV</p>
	Reading	<p>40X (max.) Full CAV</p> <p>Note) • DATA: 40X (max.) • CD-DA: 40X (max.) in audio extraction • CD-DA: 1X only in audio play • Video CD: 10X (max.) • Session closed disc: 40X (max.) • Session unclosed disc: 12X (max.)</p>
	CD-R	<p>1X, 2X, 4X, 8X, 12X, 16X (12X – 16X Partial CAV), 20X (12X – 20X Partial CAV) writing: CD-R discs specified in Orange Book Part II Ver. 3.1.</p> <p>Note) For 8X or faster writing, use CD-R discs matched their respective writing speeds</p>
	CD-RW	<ul style="list-style-type: none"> <li>• 2X writing/rewriting: Rewritable discs specified in Orange Book Part III Volume 1 Version 1.0.</li> <li>• 2X or 4X writing/rewriting: Rewritable discs specified in Orange Book Part III Volume 1 Version 2.0.</li> <li>• 4X, 8X, 10X (CLV), 4X – 10X Full CAV writing/rewriting: Rewritable discs specified in Orange Book Part III Volume 2 Version 1.0.</li> </ul>
Data Capacity	700MB (79 min.) 650MB (74 min.) 550MB (63 min.)	
Data Transfer Rate (Mode 1)	1X: 150KB/sec. 2X: 300KB/sec. 4X: 600KB/sec. 8X: 1,200KB/sec. 10X: 1,500KB/sec. 12X: 1,800KB/sec.	16X: 2,400KB/sec. 20X: 3,000KB/sec. 24X: 3,600KB/sec. 32X: 4,800KB/sec. 40X: 6,000KB/sec.
Burst Transfer Rate	<p>SCSI connection</p> <ul style="list-style-type: none"> <li>• 5MB/sec. (max, asynchronous)</li> <li>• 20MB/sec. (max, synchronous)</li> </ul> <p>E-IDE (ATAPI) connection</p> <ul style="list-style-type: none"> <li>• Programmed I/O mode 4: 16.7MB/sec.</li> <li>• Multiword DMA mode 2: 16.7MB/sec.</li> <li>• Ultra DMA mode 2 (Ultra DMA/33): 33.3MB/sec.</li> </ul>	
Data Buffer Size	8MB (3,224 sectors)	

Average Random Access Time	150 msec. (reading)
Sector Size	2,048 – 2,352 bytes
Interface	SCSI connection <ul style="list-style-type: none"> <li>• SCSI-3 Fast 20 (Ultra SCSI)</li> </ul> E-IDE (ATAPI) connection <ul style="list-style-type: none"> <li>• Enhanced IDE (E-IDE)/ATAPI</li> </ul>
Installing style	Horizontal
Disc Loading Type	Front auto-loading tray loading
Audio Out	Analog audio output Frequency range: 20 – 20,000 Hz Output level: 700mVrms Digital audio output Format: SPDIF Output level: TTL
Power Consumption	<b>CRW2200</b> drive: <ul style="list-style-type: none"> <li>• 11W (when writing or reading)</li> <li>• 4W (standby)</li> </ul> SCSI convertor: <ul style="list-style-type: none"> <li>• 1W</li> </ul>
Power Supply	5V DC $\pm 5\%$ 12V DC $\pm 10\%$
Operating Environment	Temperature +5 – +40°C Humidity 25 – 80% RH (no condensation)
Dimension	Width: 148.0 mm Height: 42.6 mm Depth: 198.1 mm ( <b>CRW2200</b> drive only) 216.7 mm (with SCSI convertor)
Weight	<b>CRW2200</b> drive: 0.9 kg SCSI convertor: 70 g

## The CRW2200 series complies with the following specifications

Country / Region	Compliance Specifications			Details
	Category	Item	Standards	
USA	Safety	Electrical	UL60950	Information Technology Equipment
		Laser	21CFR1040.10 FDA Chapter 1, Subchapter J	Class 1 Laser Product
	EMC	Emission	47CFR15 FCC Part 15, Subpart B	Class B Computing Device
Canada	Safety	Electrical	CSA C22.2 No. 60950	Information Technology Equipment
	EMC	Emission	ICES-003	Class B Computing Device
EU	Safety	Electrical	EN60950	Information Technology Equipment
		Laser	EN60825	Class 1 Laser Product
	EMC	Immunity	EN55024	Residential, Commercial and Light Industrial Areas
		Emission	EN55022	Class B Equipment
Australia New Zealand	EMC	Emission	AS/NZ 3548	Class B Equipment
Japan	EMC	Emission	VCCI	Class B Equipment
Taiwan	EMC	Emission	CNS13438	Class B Equipment

# Index

## Symbols

- 40-pin IDE cable ..... 25, 43
- 4-pin power cable..... 25, 28, 33, 46
- 5.25-inch drive bay slot..... 25
- 50-pin SCSI flat cable..... 26, 33

## A

- ANALOG AUDIO OUT connector  
..... 10, 11, 16, 44
- Audio cable ..... 16, 25, 27, 33, 44
- Audio CD ..... 16, 44, 57
- Audio input connector..... 27, 44

## B

- BIOS ..... 52
- Block size..... 23
- Buffer Underrun..... 3
- Buffer Underrun Error ..... 3
- Buffer Underrun Protection ..... 2, 3

## C

- CD EXTRA..... 58
- CD TEXT..... 2
- CD writing software..... 4
- CD-DA..... 6
- CD-R discs ..... 5
- CD-ROM..... 6, 57
- CD-RW discs ..... 5
- CLV ..... 6
- Control Panel ..... 30, 47
- CRW2200E..... 1
- CRW2200S ..... 1
- CSEL..... 42

## D

- Data CD ..... 6
- DC IN connector ..... 10
- DC INPUT connector ..... 10, 11, 19, 46
- Device Manager ..... 30, 47, 59
- Digital audio cable ..... 17, 27, 45
- DIGITAL AUDIO OUT connector  
..... 10, 11, 17, 45
- Disc tray..... 9, 50
- Disc-at-Once (DAO)..... 57
- DMA ..... 48, 49

## E

- Eject button ..... 9, 50
- Ejecting a Disc ..... 50
- Ejecting a Disc in an Emergency ..... 51
- Extraction of digital audio data..... 2

## F

- Firmware ..... 59
- Front cover ..... 25
- Front Panel ..... 9
- Full CAV..... 7

## H

- Headphone jack..... 9
- Headphone volume control ..... 9
- High Speed CD-RW discs ..... 5

## I

- IDE ..... 39
- IDE connector ..... 43
- IDE INTERFACE connector ..... 11, 43
- Installing the SCSI Convertor ..... 18

## J

- Jitter value..... 2
- Jumper switch ..... 10, 11, 20, 42

## L

- Lead-in ..... 57
- Lead-out ..... 57
- LED ..... 9, 60
- Loading a disc ..... 50
- Long-Nosed Pliers ..... 12, 35

## M

- Manual Eject hole ..... 9, 51
- MASTER ..... 39, 42
- Motherboard..... 26, 39, 43
- Multisession ..... 57

## O

- Optimum Write Speed Control ..... 2
- Orange Book ..... 5

**P**

Packet ..... 58  
Packet Writing ..... 58  
Paper clip ..... 51  
Parity check..... 22  
Partial CAV..... 6  
Phillips Screwdriver..... 12, 32, 35  
Plastic shunt ..... 20, 42  
Power cable..... 19, 34  
Primary ..... 39  
Properties ..... 30, 31, 47, 48, 55, 59  
Pure-Phase Laser System..... 2

**R**

Rear Panel ..... 10, 11  
Removing the SCSI convertor ..... 32  
Running OPC ..... 2

**S**

SafeBurn™..... 2  
Screw..... 18, 33  
SCSI card ..... 4  
SCSI convertor..... 1, 10, 18, 34  
SCSI driver..... 53  
SCSI ID number..... 21, 59  
SCSI INTERFACE connector ..... 10, 26  
Secondary..... 39  
Serial Number ..... 8  
Session ..... 57  
Session-at-Once (SAO)..... 58  
Single session..... 57  
SLAVE..... 39, 42  
Sound card ..... 27, 44, 45  
SPDIF..... 27, 45  
Sync data transfer..... 31

**T**

Termination..... 22  
Track ..... 57  
Track-at-Once (TAO) ..... 57

**V**

Video CD ..... 6

**W**

Web site ..... 5, 52, 59