

YAMAHA CDC-615 *RS*

Natural Sound Compact Disc Player

5-Disc Auto-Changeable Play Function

PLAYXCHANGE; Playing One Disc While Changing Others

Random Access Programmable Play

Random-Sequence Play

Multi-Mode Repeat Play

Remote Control Capability

Thank you for selecting the YAMAHA Compact Disc Player.



OWNER'S MANUAL

CONTENTS

Safety Instructions	2
Caution	2
Warning	3
Connections	4
Identification of Components	5
Loading the Disc/Disc Play	6
Random-sequence Play	9
Program Play	10
Repeat Play	13
Index Search	13
Notes about the Remote Control	
Transmitter	14
Notes about Handling Compact Discs ..	14
Troubleshooting	15
Specifications	15

IMPORTANT!

Please make a note of the serial number of this unit in the space indicated below.

Model:
Serial No.:

The serial number is inscribed on the rear of the unit.
Keep this Owner's Manual in a safe place for future reference.

WARNING

To reduce the risk of fire or electric shock, do not expose this appliance to rain or moisture.

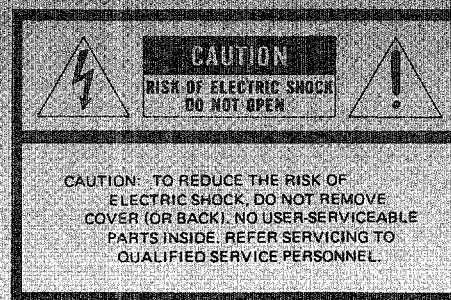

• Explanation of Graphical Symbols



The lightning flash with arrowhead symbol, within an equilateral triangle, is intended to alert you to the presence of uninsulated "dangerous voltage" within the product's enclosure that may be of sufficient magnitude to constitute a risk of electric shock to persons.



The exclamation point within an equilateral triangle is intended to alert you to the presence of important operating and maintenance (servicing) instructions in the literature accompanying the appliance.

SAFETY INSTRUCTIONS

- 1 Read Instructions – All the safety and operating instructions should be read before the appliance is operated.
- 2 Retain Instructions – The safety and operating instructions should be retained for future reference.
- 3 Heed Warnings – All warnings on the appliance and in the operating instructions should be adhered to.
- 4 Follow Instructions – All operating and other instructions should be followed.
- 5 Water and Moisture – The appliance should not be used near water – for example, near a bathtub, washbowl, kitchen sink, laundry tub, in a wet basement, or near a swimming pool, etc.
- 6 Carts and Stands – The appliance should be used only with a cart or stand that is recommended by the manufacturer.

- 6A An appliance and cart combination should be moved with care. Quick stops, excessive force, and uneven surfaces may cause the appliance and cart combination to overturn.

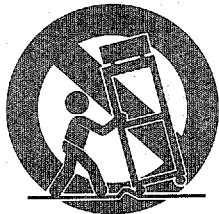

- 7 Wall or Ceiling Mounting – The appliance should be mounted to a wall or ceiling only as recommended by the manufacturer.
- 8 Ventilation – The appliance should be situated so that its location or position does not interfere with its proper ventilation. For example, the appliance should not be situated on a bed, sofa, rug, or similar surface, that may block the ventilation openings; or placed in a built-in installation, such as a bookcase or cabinet that may impede the flow of air through the ventilation openings.
- 9 Heat – The appliance should be situated away from heat sources such as radiators, stoves, or other appliances that produce heat.

- 10 Power Sources – The appliance should be connected to a power supply only of the type described in the operating instructions or as marked on the appliance.
- 11 Power-Cord Protection – Power-supply cords should be routed so that they are not likely to be walked on or pinched by items placed upon or against them, paying particular attention to cords at plugs, convenience receptacles, and the point where they exit from the appliance.
- 12 Cleaning – The appliance should be cleaned only as recommended by the manufacturer.
- 13 Nonuse Periods – The power cord of the appliance should be unplugged from the outlet when left unused for a long period of time.
- 14 Object and Liquid Entry – Care should be taken so that objects do not fall into and liquids are not spilled into the inside of the appliance.
- 15 Damage Requiring Service – The appliance should be serviced by qualified service personnel when:
 - A. The power-supply cord or the plug has been damaged; or
 - B. Objects have fallen, or liquid has been spilled into the appliance; or
 - C. The appliance has been exposed to rain; or
 - D. The appliance does not appear to operate normally or exhibits a marked change in performance; or
 - E. The appliance has been dropped, or the cabinet damaged.
- 16 Servicing – The user should not attempt to service the appliance beyond those means described in the operating instructions. All other servicing should be referred to qualified service personnel.
- 17 Power Lines – An outdoor antenna should be located away from power lines.
- 18 Grounding or Polarization – The precautions that should be taken so that the grounding or polarization is not defeated.

CAUTION: READ THIS BEFORE OPERATING YOUR UNIT

- 1 To ensure the finest performance, please read this manual carefully. Keep it in a safe place for future reference.
- 2 Install your unit in a cool, dry, clean place – away from windows, heat sources, and too much vibration, dust, moisture or cold. Avoid sources of hum (transformers, motors). To prevent fire or electrical shock, do not expose to rain and water.
- 3 Do not operate the unit upside-down. It may overheat, possibly causing damage.
- 4 Never open the cabinet. If a foreign object drops into the set, contact your dealer.
- 5 Do not place records or other objects on top of the unit; this will block the ventilation holes, cause the internal temperature to rise and may result in a failure.
- 6 Do not use force on switches, knobs or cords. When moving the set, first turn the unit off. Then gently disconnect the power plug and the cords connecting to other equipment. Never pull the cord itself.
- 7 Do not attempt to clean the unit with chemical solvents; this might damage the finish. Use a clean, dry cloth.
- 8 Be sure to read the "Troubleshooting" section on common operating errors before concluding that your unit is faulty.

WARNING

DANGER

Invisible laser radiation when open and interlock failed or defeated.
Avoid direct exposure to beam.

CAUTION

Use of controls or adjustments or performance of procedures other than those specified herein may result in hazardous radiation exposure.

As the laser beam used in this compact disc player is harmful to the eyes, do not attempt to disassemble the cabinet. Refer servicing to qualified personnel only.

To avoid electrical shock, do not open the unit. Refer servicing to qualified personnel only.

DANGER: The use of optical instrument with this product will increase eye hazard.

FCC INFORMATION (U.S.A.)

1. IMPORTANT NOTICE : DO NOT MODIFY THIS UNIT!

This product, when installed as indicated in the instructions contained in this manual, meets FCC requirements. Modifications not expressly approved by Yamaha may void your authority, granted by the FCC, to use the product.

2. IMPORTANT : When connecting this product to accessories and/or another product use only high quality shielded cables. Cable/s supplied with this product **MUST** be used. Follow all installation instructions. Failure to follow instructions could void your FCC authorization to use this product in the USA.

3. NOTE : This product has been tested and found to comply with the requirements listed in FCC Regulations, Part 15 for Class "B" digital devices. Compliance with these requirements provides a reasonable level of assurance that your use of this product in a residential environment will not result in harmful interference with other electronic devices. This equipment generates/uses radio frequencies and, if not installed and used according to the instructions found in the users manual, may cause interference harmful to the operation of other electronic devices.

Compliance with FCC regulations does not guarantee that interference will not occur in all installations. If this product is found to be the source of interference, which can be determined by turning the unit "OFF" and "ON", please try to eliminate the problem by using one of the following measures:

Relocate either this product or the device that is being affected by the interference.

Utilize power outlets that are on different branch (circuit breaker or fuse) circuits or install AC line filter/s.

In the case of radio or TV interference, relocate/reorient the antenna. If the antenna lead-in is 300 ohm ribbon lead, change the lead-in to co-axial type cable.

If these corrective measures do not produce satisfactory results, please contact the local retailer authorized to distribute this type of product. If you can not locate the appropriate retailer, please contact Yamaha Electronics Corp., U.S.A. 6722 Orangethorpe Ave, Buena Park, CA 90620.

The above statements apply **ONLY** to those products distributed by Yamaha Corporation of America or its subsidiaries.

WARNING: CHEMICAL CONTENT NOTICE!

The solder used in the manufacture of this product contains LEAD. In addition, the electrical/electronic and/or plastic (where applicable) components may also contain traces of chemicals found by the California Health and Welfare Agency (and possibly other entities) to cause cancer and/or birth defects or other reproductive harm.

DO NOT REMOVE ANY ENCLOSURE COMPONENTS!

There are no user serviceable parts inside. All service should be performed by a service representative authorized by Yamaha to perform such service.

IMPORTANT MESSAGE: Yamaha strives to produce products that are both user safe and environmentally "friendly". We sincerely believe that our products meet these goals. However, in keeping with both the spirit and the letter of various statutes we have included the preceding messages and others in various locations in this manual.

CONNECTIONS

- Before making any connections, switch OFF the power to the unit and the amplifier or other component.
- Make the connections from these terminals to the "CD" (or "AUX") terminals of the amplifier. If it does not have such terminals, use the "TAPE PB" terminals. For additional details concerning these connections, refer to the operation instructions for the amplifier being used.
- Be sure that the connection from the left ("L") LINE OUT analog output terminal and from the right ("R") terminal are to the correct corresponding (left and right) terminals of the amplifier or other component.
- If the placement of this unit causes noise to other equipment, such as a tuner, use them farther away from each other.

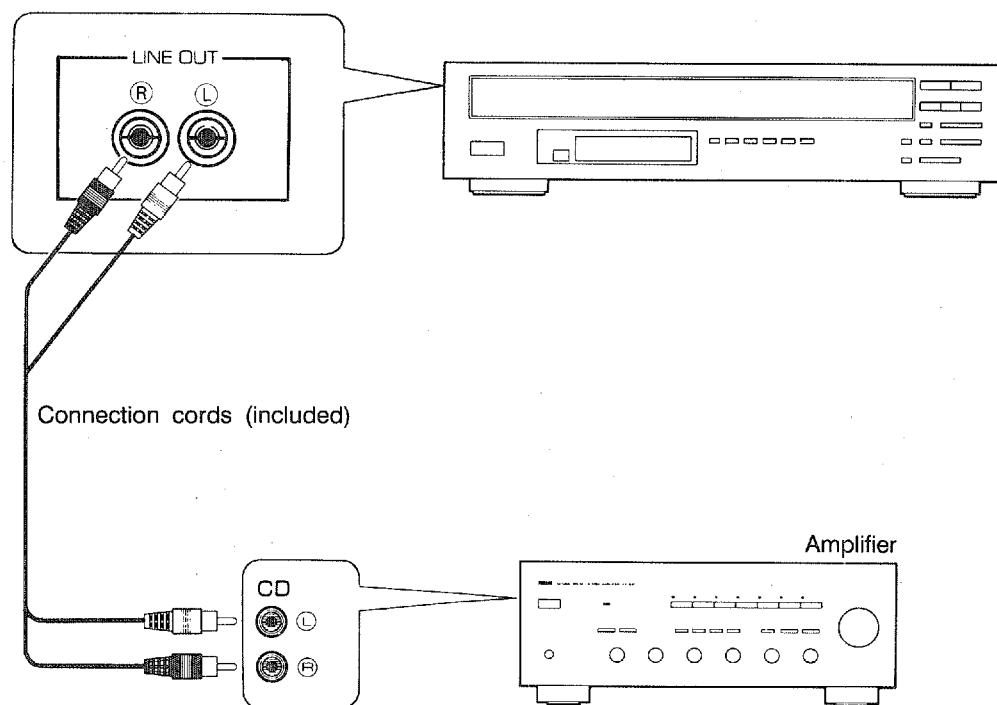

IDENTIFICATION OF COMPONENTS

FRONT PANEL

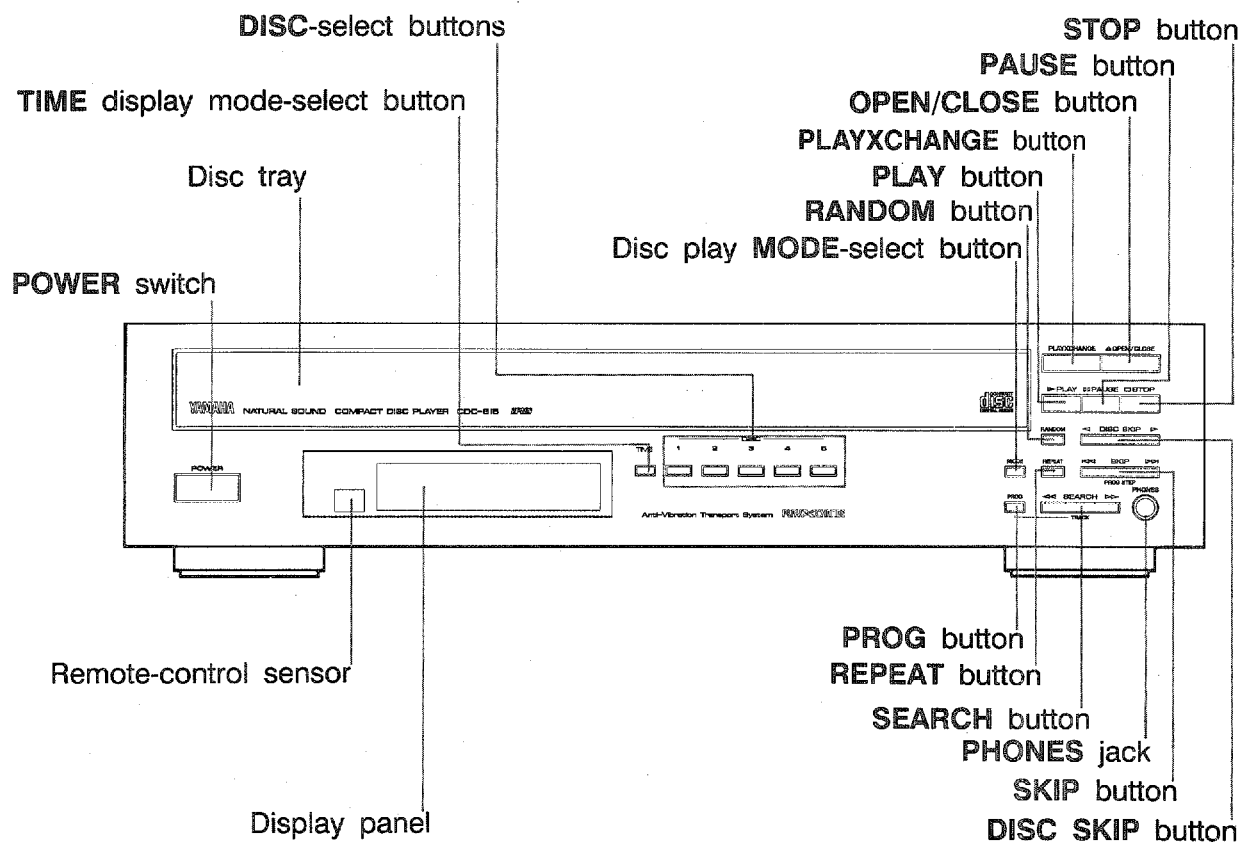

REMOTE CONTROL TRANSMITTER

* The control functions on the main unit and on the remote-control transmitter are virtually identical, with the exceptions described below.

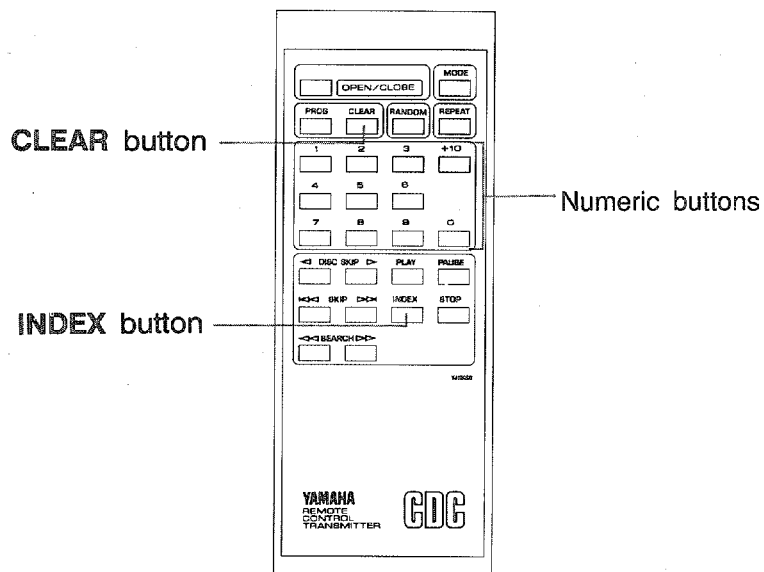

LOADING THE DISC/DISC PLAY

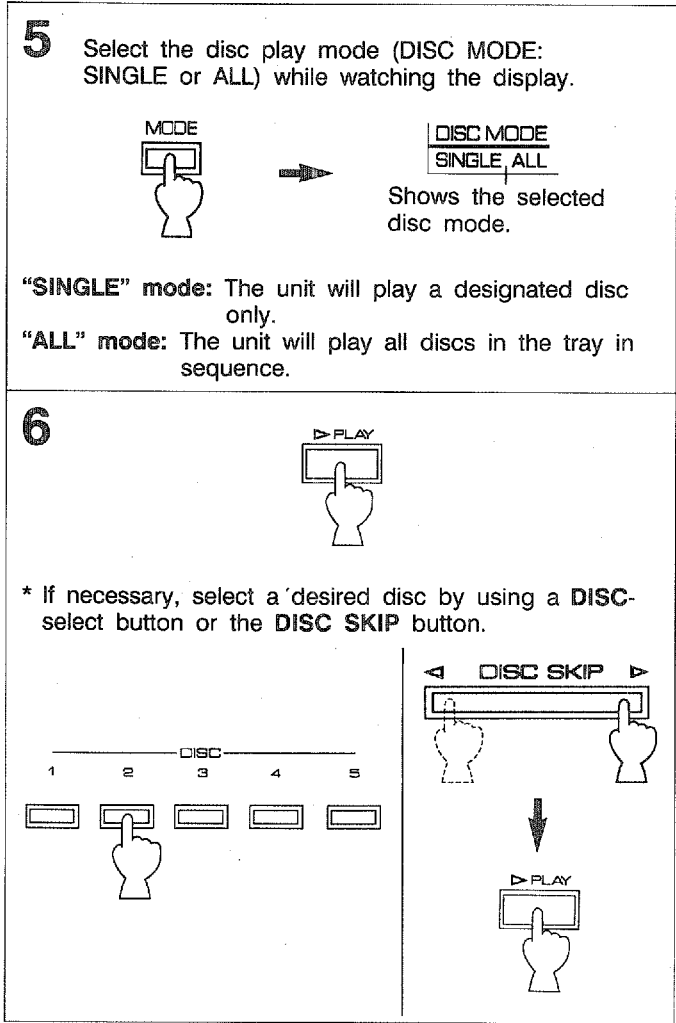
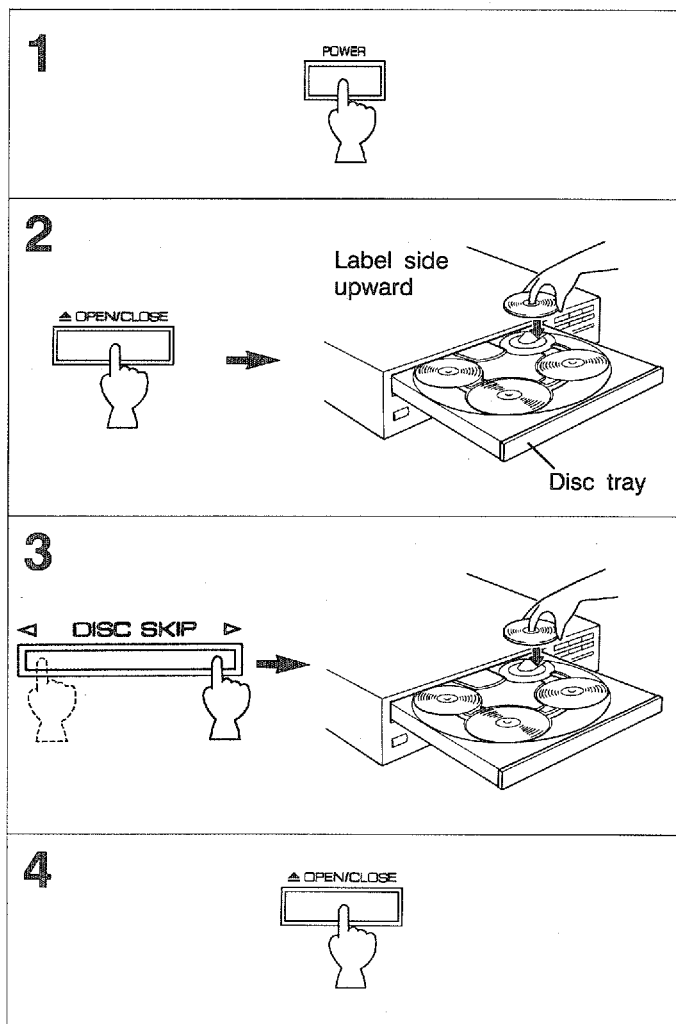
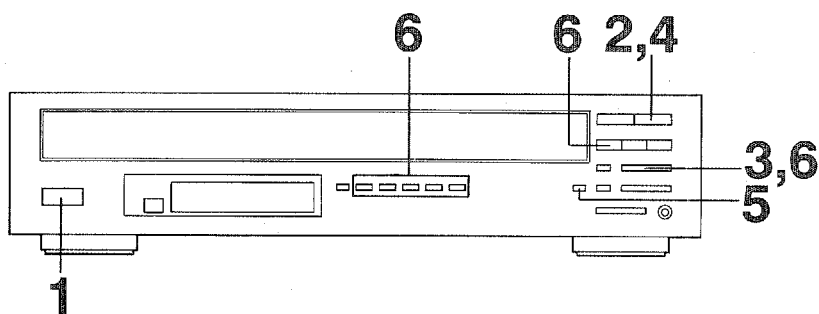

Notes:

- After closing the disc tray by pressing the **OPEN/CLOSE** button in the stop mode or after selecting any disc by using the **DISC SKIP** button, the display shows the total number of tracks and the total recorded time of the disc to be played for a few seconds.

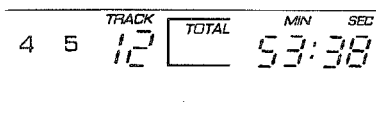

- Additionally, you can close the disc tray by pressing the **PLAY** button, a **DISC-select** button, a numeric button or the **RANDOM** button, or by pressing the front edge of the disc tray gently. If the tray is closed in these ways, play will begin automatically, however, the display will not show the total number of tracks and the total recorded time of the first disc to be played.
- During play, you can open the disc tray by pressing the **PLAYXCHANGE** button without interrupting disc play. However, in this case, pressing the **DISC SKIP** button has no effect.

To stop play temporarily

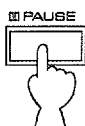

* To resume play, press the **PAUSE** button again or press the **PLAY** button.

To stop play completely

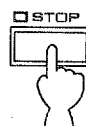

To play a desired track on the disc

DIRECT PLAY

Select a desired track by using the numeric buttons.

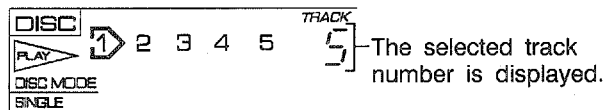
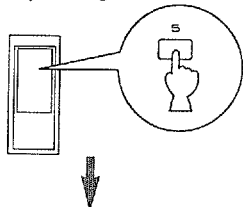

Example: To select track 25

1. Press ① twice.
2. Press ② once shortly.

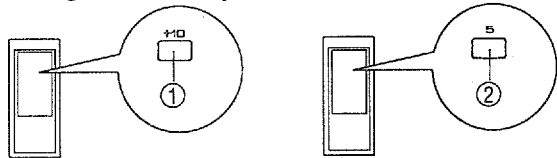

* If a track number higher than the highest track number on the disc is selected, the last track on the disc will be played.

SKIP PLAY

• To play from the beginning of the track following the one now playing



• To play from the beginning of the track now playing



• To play from the beginning of the track before the one now playing

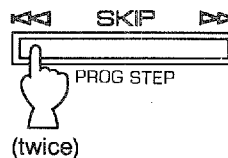

* This operation can be activated even if the unit is in the pause or stop mode.

Display information at disc play

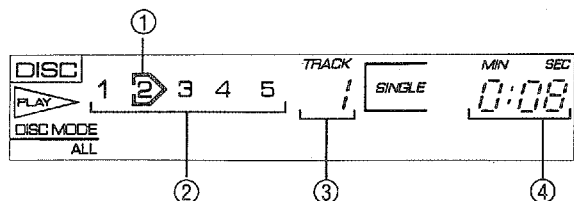

- ① Encloses the tray number of the disc standing by to be played or the disc now playing.
- ② Shows the tray numbers with discs.
- ③ Shows the track number to be played.
- ④ Shows the time displays. (Refer to "Selecting time displays" on the next page.)

When you listen with headphones

Connect the headphones to the **PHONES** jack.

To advance or reverse play rapidly (MANUAL SEARCH)

To advance rapidly

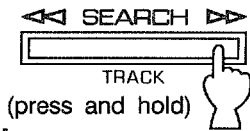

To reverse rapidly

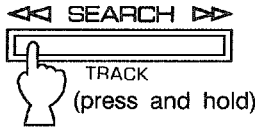

- The search speed will become faster if the **SEARCH** button is pressed and held.
- The music can be heard (although slightly garbled) during manual search in either direction. This is convenient for locating a precise position within a track, or for reviewing the contents quickly.
- When manual search in either direction is initiated during the pause mode, the action is the same, but no sound is heard.

Selecting time displays

You can select any of the four types of time displays by pressing the **TIME** display mode-select button.

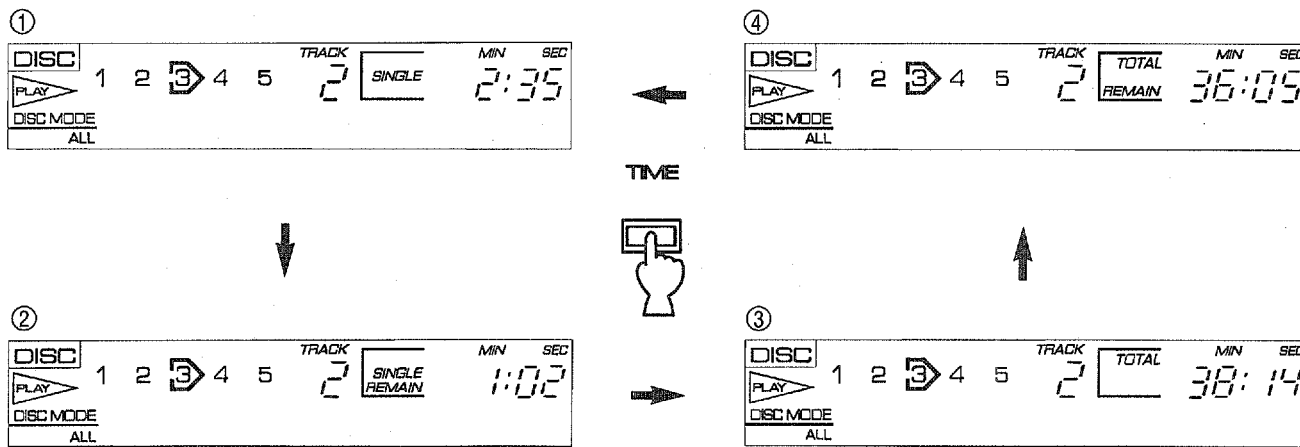

- ① Elapsed time of the track now playing
- ② Remaining time of the track now playing
- ③ Total disc play time
- ④ Total remaining time on the disc

RANDOM-SEQUENCE PLAY

You can have tracks played in a random sequence (up to 99 tracks). The unit will automatically mix up tracks from all discs or any desired disc in the disc tray.

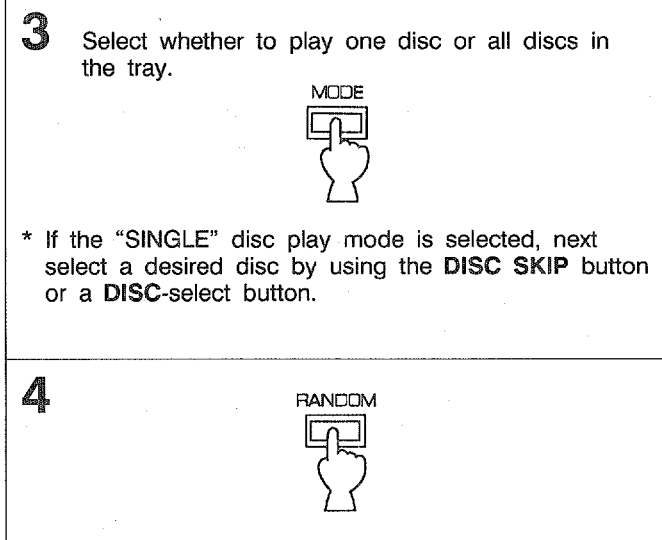
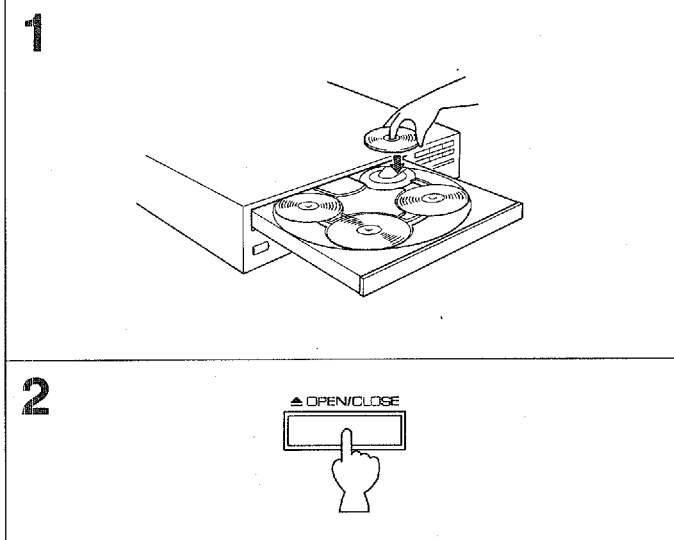
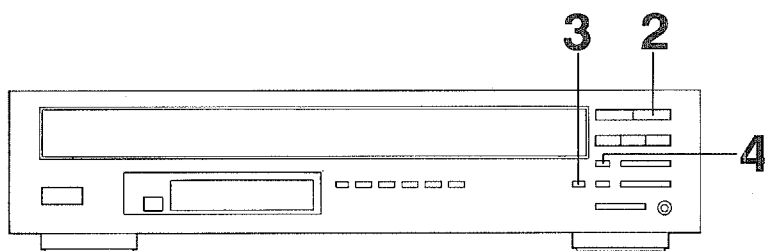

To cancel random-sequence play

Press the **STOP** button or **RANDOM** button once again, or open the disc tray by pressing the **OPEN/CLOSE** button.

Notes:

- This feature will not function during programming, or during programmed play.
- If the **SKIP** >>> button is pressed during random-sequence play, the next randomly programmed track will be played. If the **SKIP** <<< button is pressed, play will return to the beginning of the track now being played.
-  This indication appears while the unit is mixing up tracks.

PROGRAM PLAY

You can enjoy listening to your favorite tracks (or discs) in any desired order by a programmed play. Different types of programmed play can be performed according to whether the unit is in the "SINGLE" disc play mode or "ALL" disc play mode.

■ In the "SINGLE" disc play mode:

You can program tracks of a designated disc in any desired order.

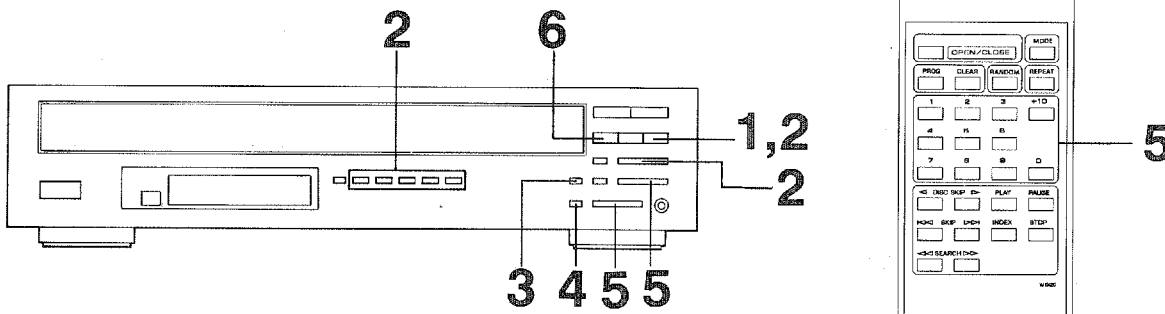

1 Set the unit in the stop mode.

2 Select the desired disc.

3

4

5 Select the desired track.

* Repeat step 5 to set more programs. You can select the same track again and again.

6

Display information at program play

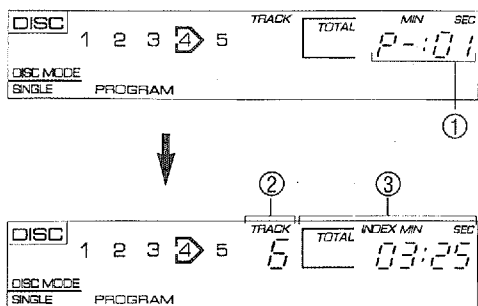

- ① Shows the program number next to be set.
 - ② Shows the selected track number.
 - ③ Shows the total time of the tracks programmed until now.
- * If the total time exceeds 99 minutes and 59 seconds, the time will not be displayed

■ In the "ALL" disc play mode:

You can program favorite tracks selected from all discs on the disc tray in any desired order.

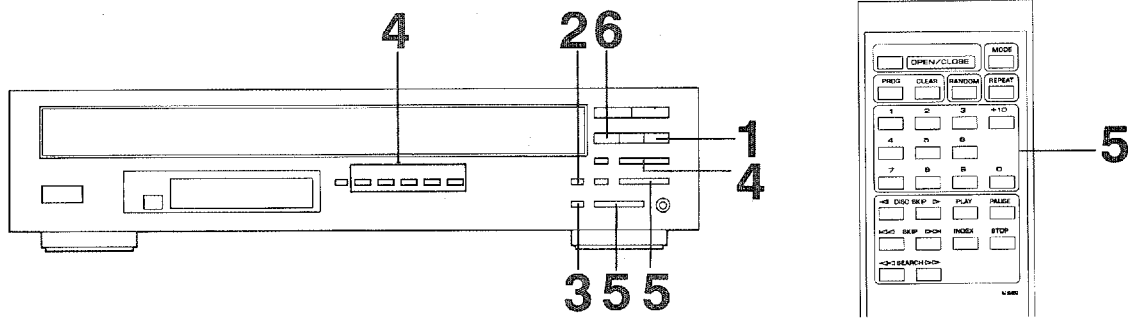

1 Set the unit in the stop mode.

5 Select the desired track.

* Repeat steps 4 and 5 to set more programs.

2

3

4 If necessary, select the desired disc.

6

Notes:

- You can set as many as 20 programs at a stretch.
- You can set a whole disc as a program by pressing "0", instead of selecting a track number. At the moment, "AL" flashes in the display. Besides you can do the same thing when "AL" lights in the display by pressing the **SEARCH** button.
- If you will make a program setting with the DISC 1 tray empty, be sure to press the **DISC SKIP** button before starting program setting.
- The total time of the programmed tracks will not be displayed, if tracks are selected from more than one disc.
- The total time of the programmed tracks will not be displayed, if the number of track higher than 20 is programmed.
- If, during program setting, the **TIME** display mode-select button is pressed, the program number display can be changed to a display of the total time of the programmed tracks. To return to the previous display, press the **TIME** display mode-select button once again.
- The **SKIP** (<<< and >>>) button can be used during playing, but only within the range of the programmed tracks.
- The **SEARCH** (<<< and >>>) button can be used during playing for search throughout all tracks, including unprogrammed tracks.

To stop program play

Press the **STOP** button. The first track number programmed will be displayed.
To resume play, press the **PLAY** button. Play begins from the beginning of the program.

To cancel a programmed setting

There are several methods, as described below.

- Press the **CLEAR** button or **STOP** button (after programming is completed, or while the unit is in the stop mode).

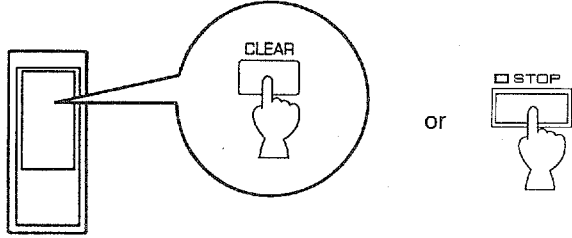

- Open the disc tray.
- Switch off the power.

To check programmed data

1. If the unit is in the play mode, press the **STOP** button.
2. Press the **PROG** button.
3. Each time the **SKIP** $\triangleright\triangleright$ button is then pressed, the track numbers and sequential order of the programmed tracks can be checked one after another. The display of the track number can be returned (sequentially in reverse order) by pressing the **SKIP** $\triangleleft\triangleleft$ button.

To correct programmed data

1. Follow the procedures in "To check programmed data".
2. Display the track number to be corrected by pressing the **SKIP** button.
3. Press a numeric button on the remote control transmitter to select a track to replace the displayed one. The previously programmed track will be cleared (from the memory) and the new one will be programmed.
4. After the correction has been completed, once again press the **PROG** button or **PLAY** button.

REPEAT PLAY

You can play any desired track or disc (set of discs) repeatedly by pressing the **REPEAT** button. The repeat-play mode will change whenever you press the **REPEAT** button.

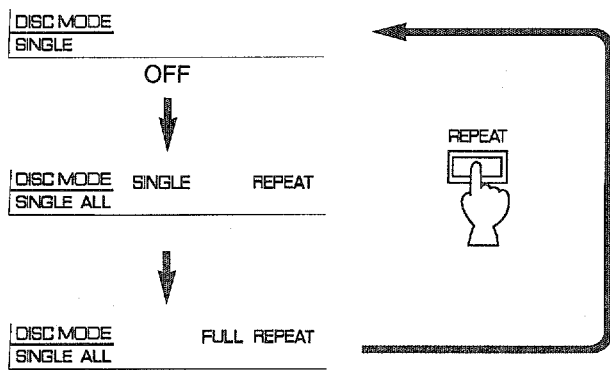

SINGLE REPEAT

Only a designated track is played repeatedly.

FULL REPEAT

In the "SINGLE" disc play mode: A designated disc is played repeatedly.
In the "ALL" disc play mode: All discs in the disc tray are played repeatedly.

Notes:

- Repeat play mode can be activated in both the play mode and stop mode.
- Repeat play is also possible during the programmed-play mode and the random-sequence play mode.

INDEX SEARCH

If the disc includes index numbers, play can be started from any desired index number.

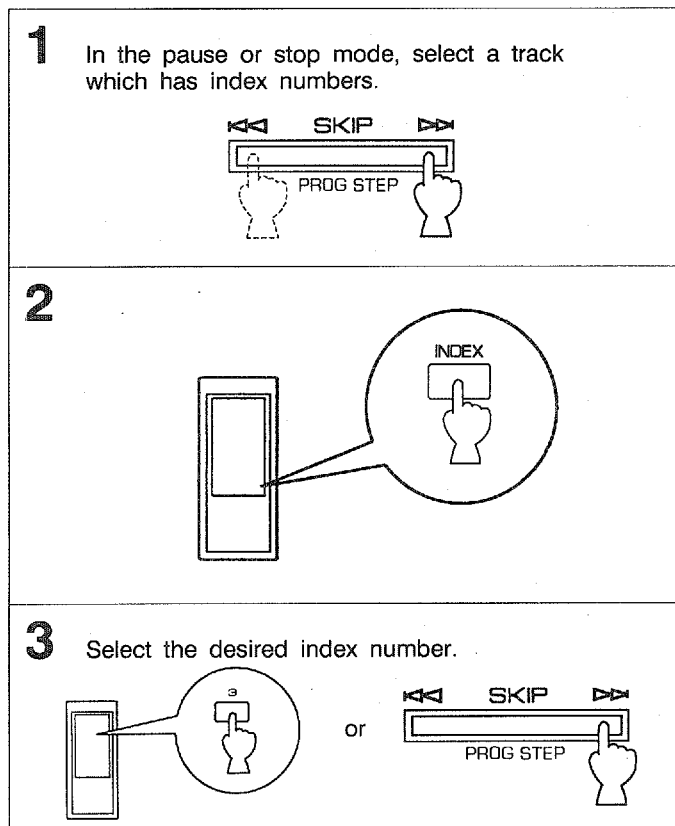

To cancel the index search function

Press the **INDEX** button.

Notes:

- Some discs have index numbers, and some do not. The index system is a method for sub-dividing tracks into smaller divisions (such as, for example, the movements within classical symphonies) for easier location of those parts. The liner notes with the disc usually tell if such index numbers are included.
- If an index number is selected that is higher than any index number on that disc, play will start from the last index number point on the disc.
- For some discs, play may begin slightly prior to the actual designated index point.
- If the disc has no encoded index points, play will begin from the start of the track selected by using the **SKIP** button.
- The index number can be designated only while the **INDEX** number display is illuminated.

NOTES ABOUT THE REMOTE CONTROL TRANSMITTER

Battery installation

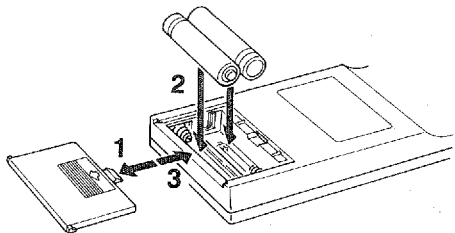

Battery replacement

If the remote-control transmitter must be used closer to the main unit, the batteries are weak. Replace both batteries with new ones.

Notes:

- Use only "AAA" (R03) batteries for replacement.
- Be sure the polarities are correct. (See the illustration inside the battery compartment.)
- Remove the batteries if the remote-control transmitter will not be used for an extended period of time.
- If batteries leak, immediately dispose of them. Avoid touching the leaked material or letting it come in contact with clothing, etc. Clean the battery compartment thoroughly before installing new batteries.

Remote-control transmitter operation range

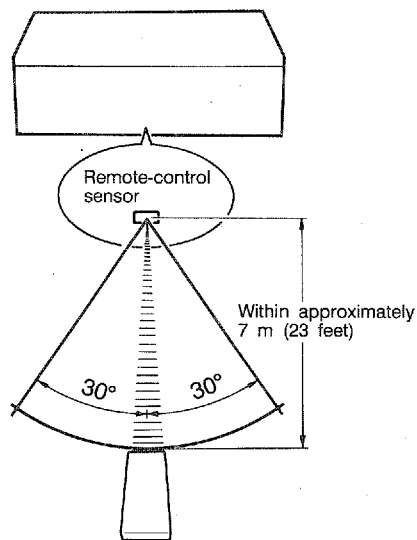

There should be no large obstacles between the remote-control transmitter and the main unit.

NOTES ABOUT HANDLING COMPACT DISCS

- This compact-disc player is designed only for reproduction of compact discs bearing the  mark. Never attempt to load any other type of disc into the unit. The unit will also play 3-inch (8-cm) compact discs.
- To remove a disc from its storage case, open the case and then press down at the center; with a finger through the center hole and the outer edges held as shown in the illustration, lift the disc out carefully.

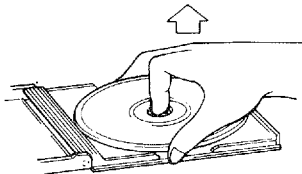

- Always handle the disc with care so that its surface is not scratched.

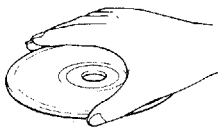

- Compact discs are not subjected to wear during play, but damage to the disc surface when the disc is being handled can adversely affect the disc's play.

- Compact discs are not affected by small particles of dust or fingerprints on their playing surface, but even so they should be kept clean. Wipe by using a clean, dry cloth. Do not wipe with a circular motion; wipe straight outward from the center.

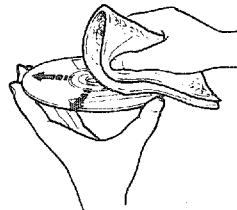

- Do not try to clean the disc's surface by using any type of disc cleaner, record spray, anti-static spray or liquid, or any other chemical-based liquid, because such substances might irreparably damage the disc's surface.
- Do not expose discs to direct sunlight, high temperature or high humidity for a long period of time, because these might warp or otherwise damage the disc.

NO!



To play a 3-inch (8-cm) CD

Place it in the inner recessed area of the disc tray. Do not put a normal (5-inch/12-cm) CD on top of a 3-inch CD.

TROUBLESHOOTING

If the unit fails to operate normally, check the following points to determine whether the problem can be corrected by the simple measures suggested. If it cannot, or if the problem is not listed in the SYMPTOM column, disconnect the unit's power cord and contact your dealer or service center for assistance.

SYMPTOM	PROBABLE CAUSE	REMEDY
The player does not switch ON when the POWER switch is pressed.	The power cord is not connected or not completely connected.	Securely connect the power cord.
The disc tray does not close completely.	A foreign object is obstructing the tray.	Carefully check the disc tray and remove the foreign object.
A disc number does not illuminate in the display.	The disc has been loaded upside down.	Load the disc correctly.
	The disc is damaged.	Check the disc carefully; replace it if necessary.
	There is moisture on the laser pickup.	Wait 20 to 30 minutes after switching the unit ON before trying to play a disc.
Play does not begin.	The disc has been loaded upside down.	Reload the disc with the label side up.
	The disc is dirty.	Clean the disc.
Play is delayed, or begins at the wrong place.	The disc may be scratched or damaged.	Check the disc carefully; replace it if necessary.
No sound.	Improper output cable connections.	Connect the cables properly. If the problem persists, the cables may be defective.
	Improper amplifier operation.	Set the amplifier controls to the correct input selection.
Sound "skips".	The player is being subjected to vibrations or impacts.	Relocate the player.
	The disc is dirty.	Clean the disc.
Sound "hums".	Improper cable connections.	Securely connect the audio cables. If the problem persists, the cables may be defective.
Noise from a nearby tuner.	The tuner is too close to the player.	Move the tuner and player farther apart.
Noise from within the disc tray.	The disc may be warped.	Replace the disc.

SPECIFICATIONS

AUDIO SECTION

Frequency response 20 Hz – 20 kHz, less than ± 1.0 dB
De-emphasis equalization ± 0.5 dB
Harmonic distortion+noise Less than 0.005% (1 kHz)
S/N ratio 100 dB
Dynamic range More than 95 dB
Wow & flutter Unmeasurable
Channel separation More than 85 dB (1 kHz)
Output voltage 2 ± 0.5 V
Headphones output (-20 dB) 110 ± 25 mV/150 ohms

GENERAL

Power requirements
U.S.A. and Canada models 120V, 60 Hz
Australia and U.K. models 240V, 50Hz
Europe model 230V, 50 Hz
General model 110/120/220/240V, 50/60 Hz
Power consumption 20W
Dimensions (W x H x D) 435 x 107.5 x 386.6 mm
 (17-1/8" x 4-1/4" x 14-13/16")
Weight 6.2 kg (13 lbs. 10 oz.)
Accessories Connection cord
 Remote control transmitter
 Batteries (size "AAA", R03)

Please note that all specifications are subject to change without notice.

YAMAHA

YAMAHA ELECTRONICS CORPORATION, USA 6722 ORANGETHORPE AVE., BUENA PARK, CALIF. 90620, U.S.A.
YAMAHA CANADA MUSIC LTD. 135 MILNER AVE., SCARBOROUGH, ONTARIO M1S 3R1, CANADA
YAMAHA ELEKTRONIK EUROPA G.m.b.H. SIEMENSSTR. 22-34, D-2084 RELINGEN BEI HAMBURG, F.R. OF GERMANY
YAMAHA ELECTRONIQUE FRANCE S.A. 17 RUE DES CAMPANULES, LOGNES 77321 MARNE LA VALLEE CEDEX 2, FRANCE
YAMAHA ELECTRONICS (UK) LTD. YAMAHA HOUSE, 200 RICKMANSWORTH ROAD WATFORD, HERTS WD1 7JS, ENGLAND
YAMAHA SCANDINAVIA A.B. J A WETTERGRENS GATA 1, BOX 30053, 400 43 VÄSTRA FRÖLUNDA, SWEDEN
YAMAHA MUSIC AUSTRALIA PTY, LTD. 17-33 MARKET ST., SOUTH MELBOURNE, 3205 VIC., AUSTRALIA

YAMAHA CORPORATION
VK48830-0 Printed in Japan BWWB-BI BB ㉿ ㊲