

Thank you for purchasing this fine Yamaha instrument.

Before You Start.....

In order to maximize performance, and to ensure safety at all times, we recommend you read through this manual thoroughly before playing your instrument.

The Parts of the Violin/Viola

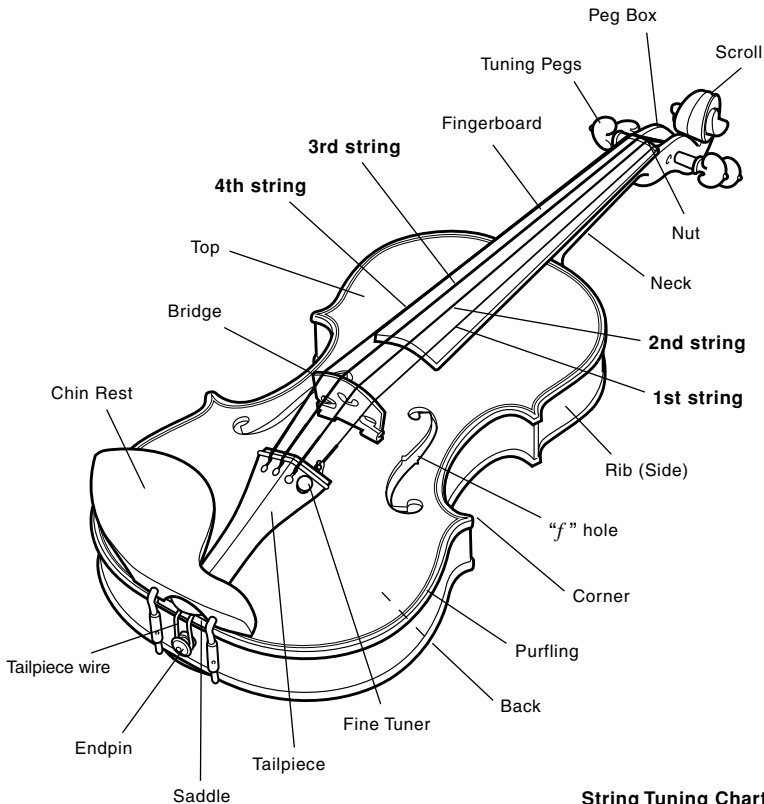

String Tuning Chart

	4th	3rd	2nd	1st
Violin	G	D	A	E
Viola	C	G	D	A

* Design and specifications are subject to change without notice.

Taking Care of Your Instrument

Please follow the guidelines set out below to prolong the lifetime of your violin or viola.

- Be careful when transporting the instrument. Make sure the instrument is handled with care and is not subjected to any rough treatment, like bumping against other objects or dropping the instrument.
- Exposing the instrument and/or bow to certain environments, particularly sudden changes of temperature, may cause severe damage. Please take the necessary precautions to protect your instrument against the following:
 - Direct sunlight.
 - Excessively high or low temperatures.
 - Excessively high or low humidity.
 - Excessive dust or strong vibration.
- Avoid leaving the instrument in a car for any extended period of time. Extreme temperatures, such as during the summer and winter months, can be harmful to both the instrument and bow.
- Make sure you regularly clean your instrument with a soft, dry cloth. Never use benzene, alcohol, or thinner. Never use aerosol cans, or any other sprays, within the vicinity of the instrument. These will damage the lacquer and general condition of the instrument.
- Prior to shipping the instrument has been adjusted and is ready for use. However, should you feel that additional adjustments are needed please contact your local Yamaha dealer, as some alterations require specialist skills.
- Ensure that you loosen the bow hair before you put it away in your case after playing.
- Plated parts such as the adjusters, metal brackets on the neck support, etc., may tarnish over time due to the makeup of the metal plating. This, however, will have no influence on the performance of these parts. When tarnish first appears, cleaning carried out in normal maintenance and care may be enough to remove the tarnish. (If the tarnish progresses normal cleaning may not be sufficient.)
- As the instrument and many of its parts are made of natural wood, there may be some cases, where objects that come in contact with the wood (hands, parts of the body, cleaning cloth, etc.) may become discolored. Color on body parts is not harmful to your health but you should wash and remove it with water. We can not be held responsible for discoloration of clothing, etc., or the discoloration of the wood.

This Yamaha violin is finished with a high-quality oil varnish that is well suited for the instrument's acoustic characteristics. As the oil finish is soft, high temperatures and high humidity can soften the finish further sometimes causing the cloth inside of the case to stick to the violin (it will not harm the violin's performance or durability). Please avoid storing the violin in places susceptible to high temperatures and/or high humidity. Also, to keep the instrument clean, use a soft cloth to remove smudges and dirt after use.

Safety Tips

Please consider the following points of safety.

- To prevent contact, always maintain sufficient distance between yourself and other people/objects when playing the instrument. The shape of the bow is capable of causing harm if care is not taken at all times.
- If possible, hold your bow still when not in use. Do not swing, throw or engage in any other movements that could potentially cause damage to other people/objects, or to the bow itself.
- Take care not to pinch your hands or fingers when closing the case.

■ Cautions Relating to the Instrument

The instrument's body is made from natural woods (spruce, maple, ebony, etc.) that are held together with glue. For this reason, there may be some cases in which sudden changes in temperature or humidity cause the glue to fail, or tuning or performance related problems. Please pay close attention to the environment and manner in which you use the instrument.

- In summer or winter seasons, wait until the instrument has adjusted to room temperature before playing.

Warning!

- When tuning or changing the strings, never hold the instrument close to your face. If the string breaks unexpectedly, it may result in injury to the eyes or face.
- Always change the strings one at a time, never all at once. The removal of all four strings from the instrument will result in the bridge collapsing, and the tailpiece falling off. Other problems may occur.
- When tuning the strings, do not over loosen or over tighten the fine tuner. Doing so may result in damage to the instrument, or cause noise disturbances during performance.

■ Cautions Relating to Items Included with the Set and Accessories

- The following parts are included in the set.

Bow, case, and rosin.

- When the case is equipped with a hygrometer:
This hygrometer does not provide precise measurements so it should only be used as a guide when caring for the instrument.

● About the Bow

- Using the supplied rosin, apply rosin to the bow hair before use.
Make sure that the rosin is applied evenly over the entire length of the bow. (When applying rosin for the first time, apply abundantly.)
- Always loosen the hair on the bow when the bow is not used.

Rotate the button to adjust the bow hair tension.



- Make sure that the bow hair is sufficiently loosened before placing the bow in the case.
- Before storing any bow in the case other than the one that came with the instrument, make sure its length allows for proper and secure storage in the case.

Warning!

- The bow's shape can make it a danger to persons and objects close by. When playing the instrument make sure sufficient space is provided between you and the next person or object, etc. Never treat the bow in a rough manner, such as swinging or throwing the bow.

Before Playing the Instrument

■ About the Bridge

The instrument is shipped from the factory with its bridge properly set and aligned on the instrument's top.

After confirming that the bridge is in proper alignment, tune the instrument.

- Four notches in the bridge provide proper spacing between the strings.

Make sure that each string is set in its corresponding groove as shown in the illustration right.

- Make sure that the side of the bridge facing the tailpiece is standing at a right angle to the top of the instrument. If the bridge is leaning either direction, place the instrument on a stable surface, slightly loosen the strings then using both hands, gently adjust the bridge's angle. Make sure that the strings do not come out of their notches.

* **Playing with a poorly aligned bridge can result in poor sound quality, and deformation or damage to the bridge.**

G D A E : violin
C G D A : viola

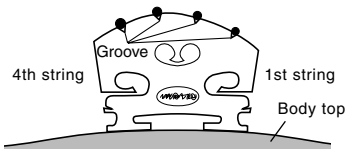

[Looking from the tailpiece]

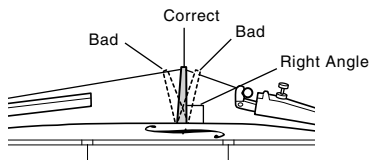

The side of the bridge facing the tailpiece should be at a right angle to the body of the instrument.

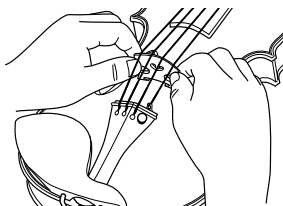

■ Tuning

- The strings are tuned to the following pitches;
On the violin, the 1st string is tuned to E, the 2nd string to A, the 3rd string to D, and the 4th string to G.
On the viola, the 1st string is tuned to A, the 2nd string to D, the 3rd string to G, and the 4th string to C.
Use a piano, tuning fork, tuner, etc., and adjust the pitch of each string using the tuning pegs or adjuster. When rotating the peg, apply firm pressure towards the head stock.
- After tuning is complete, make sure that the tailpiece side of the bridge is still properly aligned. If the bridge is leaning in either direction, slightly loosen the strings and carefully re-align the bridge using both hands.

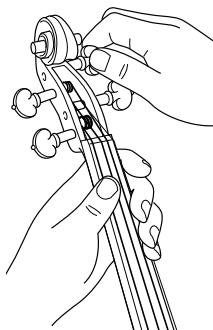

Changing Strings

■ Before Attaching the Strings

Before you string the instrument, set the fine tuner so that it is in the middle of its adjustment range.

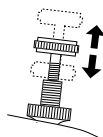

The fine tuner should be set to the middle of its adjustment range.

● For instruments equipped with fine tuners

[Violin 4/4, 3/4, 1/2, Viola]

At the tailpiece, hook the string's ball end onto the fine tuner's notch.

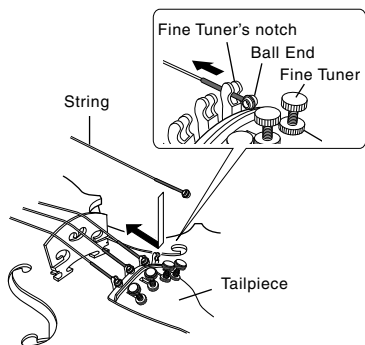

[Violin 1/4, 1/8]

At the tailpiece, hook the string's ball end into the slot on the string hole.

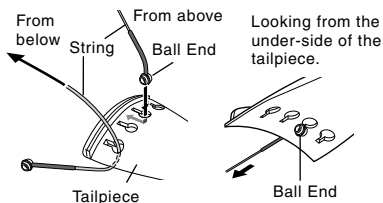

With the strings loosely extending up towards the neck, attach the fine tuners to the strings, as shown below.

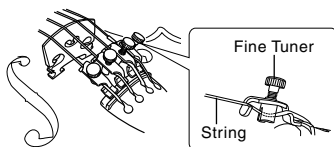

● For instruments equipped with a fine tuner on the 1st string only

[4th, 3rd and 2nd strings]

At the tailpiece, hook the string's ball end into the slot on the string hole.

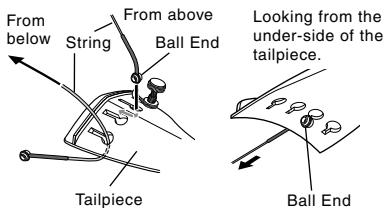

[1st string]

At the tailpiece, hook the string's ball end onto the fine tuner's notch.

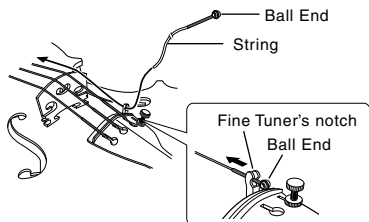

Changing Strings

● For instruments equipped with a tailpiece with set-in adjusters

At the tailpiece, hook the string's ball end onto the fine tuner's notch.

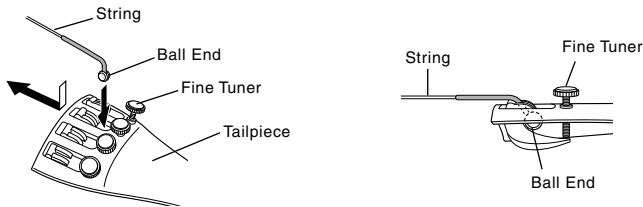

■ Winding the Strings

Insert the string into the hole on its corresponding tuning peg and wind the string onto the peg as shown below. Apply some pressure (push in) to the peg as you turn it. (Fig. A)

■ Checking the Bridge's Position

While tuning or changing the strings, check the position and angle of the bridge. (Fig. B)

(Fig. A)

Make two winds towards the end of the peg and the remaining winds towards the peg handle.

Wind the string as shown below.

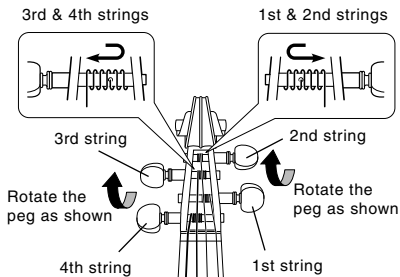

(Fig. B)

Make sure the strings are seated in their corresponding notches on the bridge.

Make sure the bridge is positioned between the notches in the "f" holes as shown below.

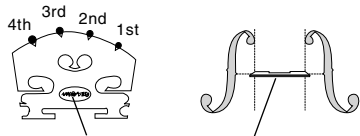

Make sure the side of the bridge with the logo is facing the tailpiece.

The side of the bridge facing the tailpiece should be at a right angle to the body of the instrument.

